



ADVANCED
FASTENING
SOLUTIONS

PRODUCT GUIDE **2019/2020**



PRODUCT GUIDE **2019/2020**



ADVANCED FASTENING SOLUTIONS

We **DEVELOP** and **PRODUCE** solutions dedicated to electrical installation and professional construction, combining our Italian and European **COMPETENCES**.
The only multi-product and multi-solution offer for your profession.



ELEMATIC the cabling and multi-material anchoring systems specialist.

THE STRENGTH OF A GLOBAL GROUP



Elematic is part of ITW, an American **MULTINATIONAL** group with over 100 years of history: the **IDEAL PARTNER** for every professional looking for innovative, differentiating, and high-quality products.

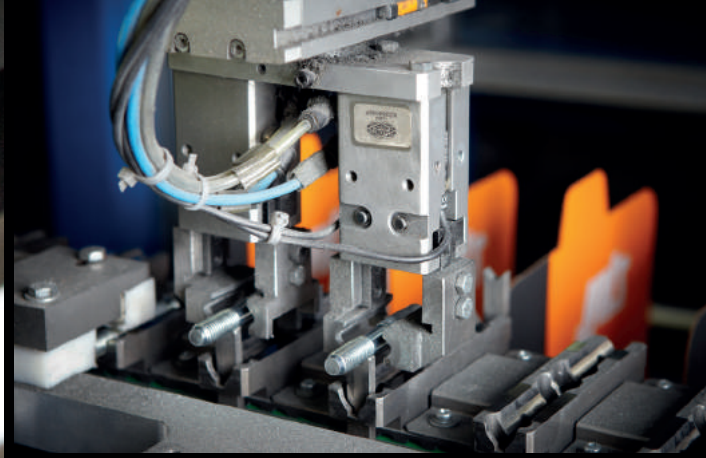

PADOVA

Viale Regione Veneto, 5
35127 Padova Z.I.
Italia

Registered office
Anchors production

CAZZAGO

Viale Lombardia, 10
30030 - Cazzago di Pianiga
Venezia - Italia

Commercial office
Research & Development
Logistics

CADONEGHE

Via Edison, 23
35010 Cadoneghe
Padova - Italia

Cable ties production
Cabling accessories
production

BUJE CROATIA

Momjanska, 3
52460 Buje - Croatia

Cable ties production
Cabling accessories
production

INOWROCLAW POLONIA

Poznańska 375, 88-100
Inowrocław - Polonia

Cable protection R&D
and production



SYSTEM CERTIFICATIONS

The company is certified **ISO 9001:2015** for the design and manufacturing of cable ties and fixing systems with technopolymers, and trading of cabling and fixing accessories. The certification guarantees the quality of the production processes thanks to the implementation of strict operational procedures and quality controls at all levels.



ENVIRONMENTAL CERTIFICATIONS

Aware of the importance of our impact on the environment, we undertook an environmental certification procedure to reduce our impact on the environment as much as possible. All our Italian sites are certified according to **ISO 14001: 2015** standard for the design and production of cable ties and fixing systems in technopolymers by injection moulding, and trading of cabling and fixing accessories.

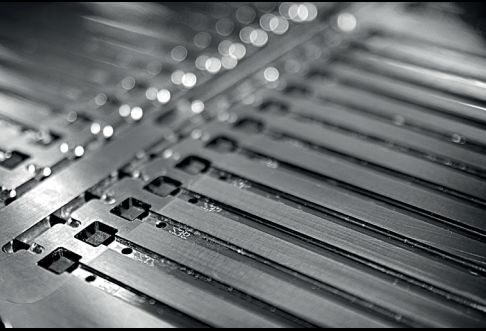
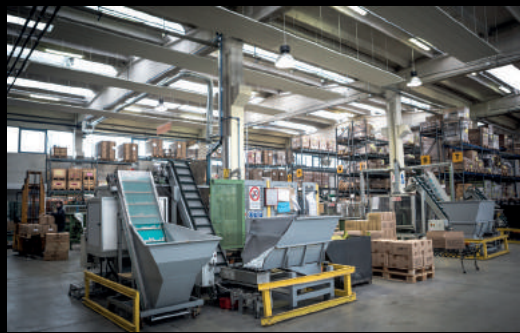

PRODUCT CERTIFICATIONS AND COMPLIANCE

CABLE TIES CERTIFICATIONS



UL LISTED



UL RECOGNIZED

UL – FILE E86244

Elematic cable ties are recognized by UL (Underwriters Laboratories Inc.) according to UL 62275 standard - Cable Management Systems - Cable Ties for Electrical Installation.



DNV-GL - FILE E-12898

DNV-GL certification guarantees that Elematic cable ties comply to the "Det Norske Veritas" and "Germanischer Lloyd" standards for cable fixing in naval and offshore constructions, for both internal and external applications.



LLOYD'S REGISTER CERTIFICATE N° 09/00025 (E1)

The English Lloyd's Register homologation certifies the mechanical properties and flame resistance of Elematic cable ties in naval construction.



BUREAU VERITAS CERTIFICATE N° 13190/CO BV

This homologation, according to the IEC standard 60092-IEC 62275, ensures that Elematic cable ties comply to the "Bureau Veritas" standard for cables fixing in shipbuilding.



R.I.N.A. CERTIFICATE N° ELE040812CS

The Italian Naval Register homologation, according to the IEC EN 60092-101 "Electrical Installations in Ship" certifies that Elematic cable ties have been tested for flame propagation in shipbuilding.

Self-certification



CE MARKING

Certifies the declaration of conformity of Elematic cabling products to the relevant directive.

CEI EN 62275

Elematic cable ties have been internally tested following the European standards "Cable Ties for electrical installations". Elematic cable ties passed the tests required by these standards.

CABLE PROTECTION CERTIFICATIONS



UL – FILE E228117

Elematic heat-shrinking tubes have obtained the UL (Underwriters Laboratories Inc.) recognition according to UL 224 - Extruded Insulating Tubing standard.



Elematic PVC insulation tapes have obtained the VDE (Verband Deutscher Elektrotechniker) recognition according to the IEC standard 60454-3-1-7 / F-PV-CP / 90

Self-certification

EN 60684

Elematic heat-shrinking tubes have been internally tested following the European standards "Flexible insulating sleeving". Elematic heat-shrinking tubes passed the tests required by these standards. The results are in line with the specifications in the respective product pages on this catalogue.

MECHANICAL AND CHEMICAL ANCHORS CERTIFICATIONS



For all Elematic anchors that satisfy the European Assessment Document (EAD) a European Technical Approval (ETA - European Technical Assessment) is issued.

Option 1: for cracked and non-cracked concrete

Option 7: for non-cracked concrete

ETAG 014: for insulators fixing in composite systems (ETICS)

ETAG 020: nylon anchors for fixing on concrete and masonry

ETAG TR 023: for structural joints with bars of post-installation reinforcement



Fixing system with fire resistance data



Anchor tested under seismic actions



Product with very low content of Volatile Organic compounds, class A+. Ideal for indoor use

MATERIAL CERTIFICATIONS

WEEE - ELV - REACH (REGULATION EC 1907/2006)

The materials used by Elematic to produce cable ties, accessories and various systems comply with the European directives: WEEE (waste electrical equipment - 2012/19/EU) ELV (end of life vehicles - 2000/53/EC) REACH (the materials used to produce our articles, do not contain substances listed in the "List of Candidate Substances" or in Annex XIV of the EC Regulation 1907/2006).

ROHS - (REGULATION EC 2002/95/CE)

The materials used by Elematic to produce cable ties, accessories and various systems comply with the European RoHS directive - 2002/95 / EC (Restriction of Hazardous Substances Directive) adopted in February 2003 by the European Community. The legislation imposes restrictions on the use of certain hazardous substances in the construction of various types of electrical and electronic equipment.

SUPPORT MATERIALS GUIDE



NON-CRACKED CONCRETE

Compressed concrete due to its position in the structure. Assumed of resistance $\geq C20 / 25$ ($f_{ck} \geq 250$). Critical applications for safety fixing requires specific products (Technical approval European Option 7)



CONCRETE HOLLOW BLOCK

Agglomerated hollow cementitious elements, with perforated volume and variable shape. Used for partitioning. Fixing requires specific anchors. The cut is possible with universal discs.



AERATED CONCRETE

Gasbeton. Elements obtained from ground sand, lime and cement, porous, friable and light. Employed on masonry constructions, load-bearing and non-load bearing walls. Compressive strength is 3 N/mm^2 approx. Fixing requires the use of specific products.



TENSE/CRACKED CONCRETE

Uncompressed concrete that is under tension due to its position in the structure. Assumed resistance $\geq C20 / 25$ ($f_{ck} \geq 250$). Critical applications for safety fixing requires specific products (Technical approval European Option 1).



UNRENDERED HOLLOW BRICK/ RENDERED HOLLOW BRICK

Clay elements, with 45% or more of hollow volume. Tied with cement mortar. Fixing and cutting requires specific products.



DRYWALL

Plaster slabs enclosed between two sheets of tight cardboard. Low resistance, friable. The single slabs are typically 10 mm or 13 mm thick. The walls are made in single, double or triple slab. Fixing requires specific products.



NATURAL STONE

Compact, high resistance natural stones such as granite, basalt, marble, porphyry, dolomite. Same assumed resistance applied to concrete for fixing purposes. For security applications testing is required.



LIGHTWEIGHT CONCRETE

Concrete with a lower density ($< 600 \text{ kg / m}^3$) less than normal concretes due to light conglomerates (eg clay, polystyrene) instead of inert materials.



WOOD

Solid aged wood, belong to the types and categories 1 and 2 listed on UNI 8198 and considered from Eurocode 5.



FULL BRICK

Clay elements, full or with hollow volume $< 15\%$, linked between them with mortar. Used for exposed brick walls, walls bearing and not. Fixing requires products specific. Cutting is possible with universal disks.



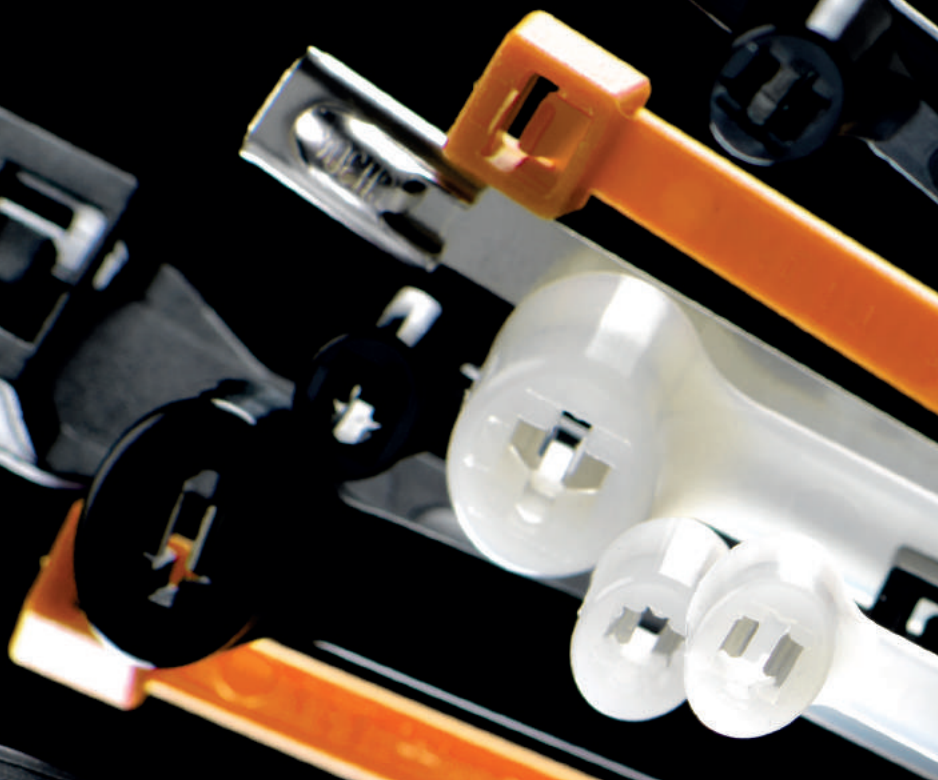
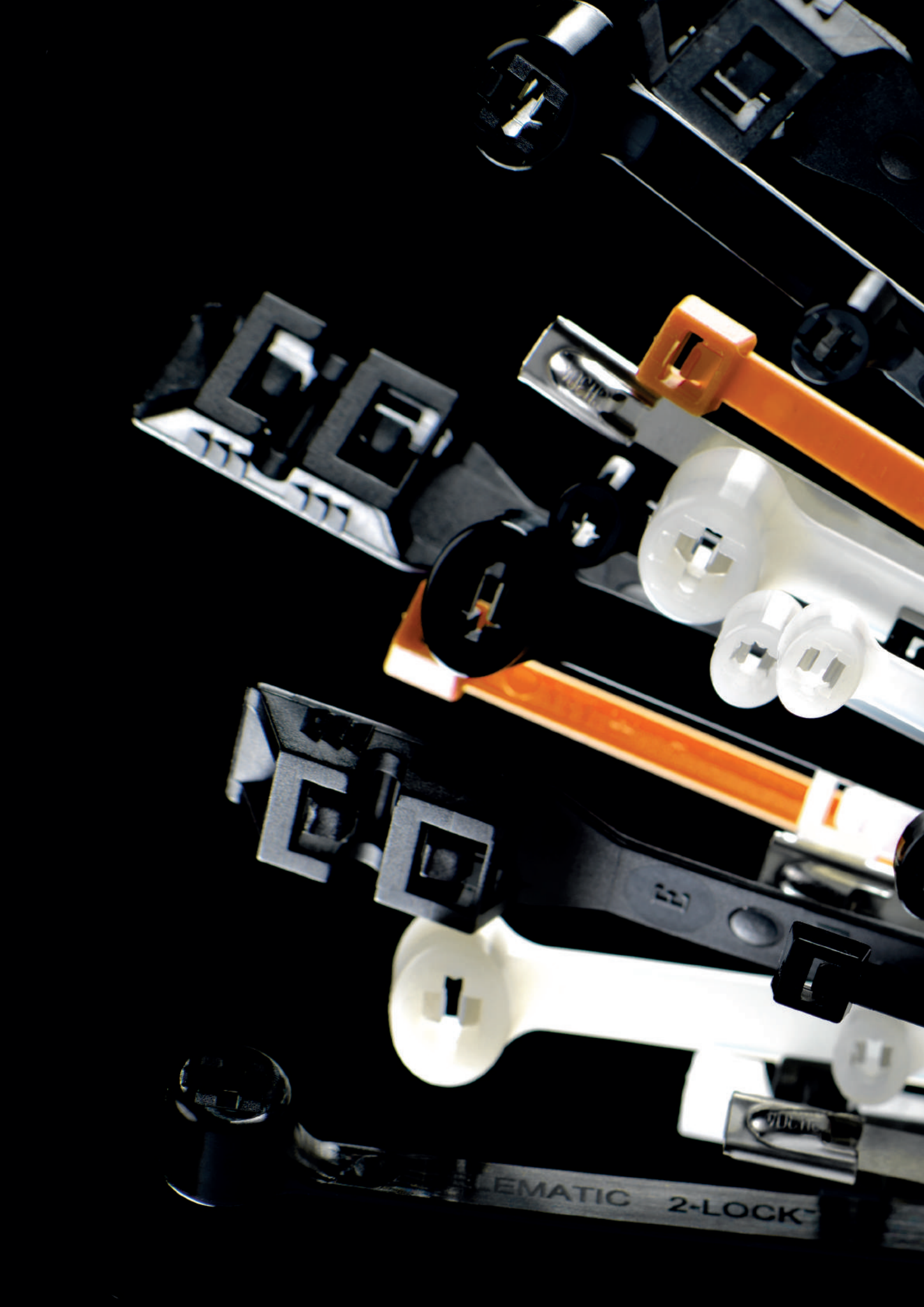

CABLES TIES AND ACCESSORIES

DOUBLE METALLIC TOOTH CABLE TIES 2-LOCK™	14
STANDARD CABLE TIES Standard Cable Ties	16
INSTALLATION CABLE TIES Easy Belturing Belturing Plus Colspeed	19 20 22
SPECIAL CABLE TIES UV-Resistant Cable Ties Heat Resistant Cable Ties Self-extinguishing Cable Ties Detectable Cable Ties Coloured Cable Ties Identification Cable Ties Fixing Cable Ties Releasable Cable Ties	23 24 25 26 27 28 29 30
STAINLESS STEEL CABLE TIES Colsteel	32
ACCESSORIES FOR CABLE TIES FIXING Anchoring Base for Cable Ties Threaded Fixing Base for cable ties Fixing Cradle Mounting Base Screw Fixing Mounts Two-way Mounting Base Detectable Two-way Mounting Base	34 35 36 36 37 38 40
SUPPORTS FOR CABLE FIXING Self-adhesive Fixing Clips for Round Cables Self-adhesive Fixing Clips for Flat Cables Cable Clips	41 42 43

E **ELEMATIC**

2-LOCK

The only double steel tooth cable tie



WO 2012/075034 A1
EP 2 646 338 B1



Designed and manufactured
in Italy



DNV-GL TAE000000G



UL E86244



ELE120817CS001





MAXIMUM GRIP

The innovative double tooth locking system allows to reach nominal grip values up to 80 kg.



SAFETY AND RELIABILITY

The INOX AISI 316 steel double cage is incorporated in the head: no detachment for total security and reliability.



RESISTANT TO UV RAYS AND LOW TEMPERATURES

Safe and guaranteed even in low temperatures applications, up to -40°C . The 2-LOCK ties in black are produced in resistant polyamide, durable against UV rays and atmospheric agents, for permanent installations in external environment.



INNOVATION AND EXCLUSIVITY

The 2-LOCK innovative locking system and the exclusive production process are internationally patented.

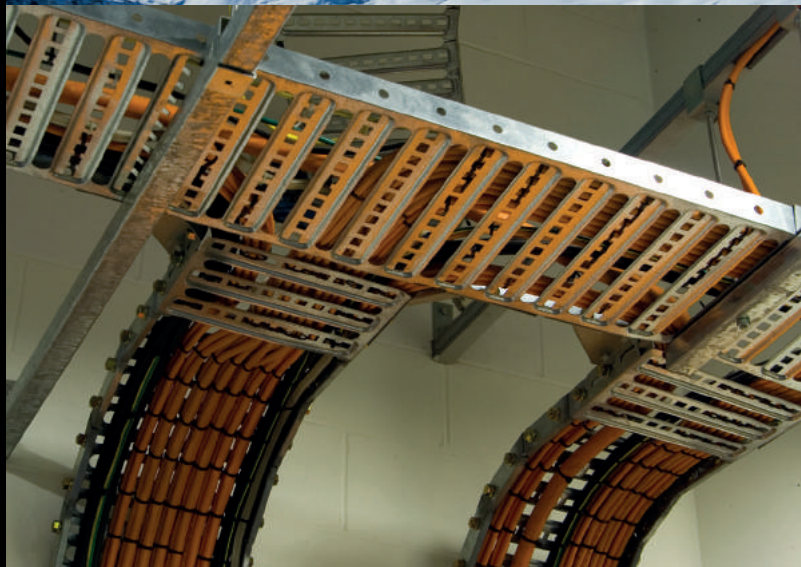

2-LOCK™ Cable Ties

Professional cable ties, in polyamide 6.6, having an innovative double locking system in stainless steel: maximum performance and reliability

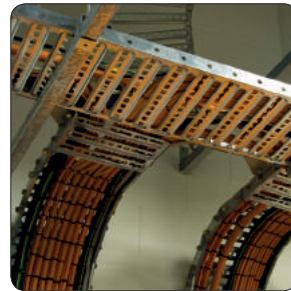

Features and benefits

- The special AISI 316 stainless steel locking system, directly incorporated into the head during the injection manufacturing process, allows the highest performances and reliability
- The double tooth mechanism allows a double locking, on both side of ties, for an ultimate tightening of the bundles
- Perfect wiring: the smooth profile without racks offers infinite adjustment along the length of the tie and always a correct tensioning for any bundling diameters
- Resistance and reliability at low operating temperature up to -40 °C
- 2-LOCK™ cable ties, in black color, are manufactured of special UV-resistant polyamide, for extreme outdoor applications
- 2-LOCK™ cable ties are packed in an innovative resealable bag: this avoids any dispersion after the first opening, maintaining the superior characteristics of the ties.

Technical documents

Body material	polyamide 6.6
Cage material	stainless steel INOX AISI 316
Halogen	absent
Humidity absorption (50% relative humidity)	2,7%
Working temperature	-40°C ÷ +85°C
Installation temperature	-40°C ÷ 60°C
Flammability rating	UL94 class V2

Resistance external agents:
UV-resistant (2-Lock in black color). Excellent chemical resistance to aromatic solvents, oils, greases, oil-based products. Good chemical resistance to bases. Limited resistance to acids. Does not resist to phenol and chlorinated solvents. Corrosion Resistant (Overmoulded Locking System in A4-AISI 316 stainless Steel)

Applications

- Control panels
- Switchboards
- Electrical building installation
- Industrial plants
- Automotive wiring harness
- Solar energy Installations
- Outdoor and special applications

Approvals and certifications

Compliant with CEI EN 62275 standard



HALOGEN FREE

2-LOCK™ NATURAL



Description	Width (mm)	Length (mm)	Ø bundle max (mm)	Tensile Strength (kg)	Tensile Strength (N)	Pack (pcs.)	Code
2-LOCK 2,5x100	2,5	100	21	15,30	150	100	1203
2-LOCK 2,5x200	2,5	200	50	15,30	150	100	1207
2-LOCK 3,5x140	3,5	140	35	25,5	250	100	1209
2-LOCK 3,5x200	3,5	200	50	25,5	250	100	1214
2-LOCK 3,5x290	3,5	290	80	25,5	250	100	1210
2-LOCK 4,5x200	4,5	200	50	36,72	360	100	1215
2-LOCK 4,5x250	4,5	250	68	36,72	360	100	1216
2-LOCK 4,5x290	4,5	290	80	36,72	360	100	1217
2-LOCK 4,5x360	4,5	360	101	36,72	360	100	1219
2-LOCK 7,5x220	7,5	220	55	79,56	780	100	1225*
2-LOCK 7,5x360	7,5	360	100	79,56	780	100	1227

*not DNV-GL certified

2-LOCK™ BLACK - UV-RESISTANT



Description	Width (mm)	Length (mm)	Ø bundle max (mm)	Tensile Strength (kg)	Tensile Strength (N)	Pack (pcs.)	Code
2-LOCK 2,5x100	2,5	100	21	15,3	150	100	1303
2-LOCK 2,5x200	2,5	200	50	15,3	150	100	1307
2-LOCK 3,5x140	3,5	140	35	25,5	250	100	1309
2-LOCK 3,5x200	3,5	200	50	25,5	250	100	1314
2-LOCK 3,5x290	3,5	290	80	25,5	250	100	1310
2-LOCK 4,5x200	4,5	200	50	36,72	360	100	1315
2-LOCK 4,5x250	4,5	250	68	36,72	360	100	1316
2-LOCK 4,5x290	4,5	290	80	36,72	360	100	1317
2-LOCK 4,5x360	4,5	360	101	36,72	360	100	1319
2-LOCK 7,5x220	7,5	220	55	79,56	780	100	1325
2-LOCK 7,5x360	7,5	360	100	79,56	780	100	1327

2-LOCK™ NATURAL - 20 PCS PACK



Description	Width (mm)	Length (mm)	Ø bundle max (mm)	Tensile Strength (kg)	Tensile Strength (N)	Pack (pcs.)	Code
2-LOCK 3,5x200	3,5	200	50	25,5	250	20	1214/20
2-LOCK 3,5x290	3,5	290	80	25,5	250	20	1210/20
2-LOCK 4,5x200	4,5	200	50	36,72	360	20	1215/20
2-LOCK 4,5x290	4,5	290	80	36,72	360	20	1217/20
2-LOCK 4,5x360	4,5	360	101	36,72	360	20	1219/20
2-LOCK 7,5x360	7,5	360	100	79,56	780	20	1227/20

2-LOCK™ BLACK - UV-RESISTANT - 20 PCS PACK



Description	Width (mm)	Length (mm)	Ø bundle max (mm)	Tensile Strength (kg)	Tensile Strength (N)	Pack (pcs.)	Code
2-LOCK 3,5x200	3,5	200	50	25,5	250	20	1314/20
2-LOCK 3,5x290	3,5	290	80	25,5	250	20	1310/20
2-LOCK 4,5x200	4,5	200	50	36,72	360	20	1315/20
2-LOCK 4,5x290	4,5	290	80	36,72	360	20	1317/20
2-LOCK 4,5x360	4,5	360	101	36,72	360	20	1319/20
2-LOCK 7,5x360	7,5	360	100	79,56	780	20	1327/20

Hand tools
from page 190

Standard Cable Ties

Technical cable ties, in polyamide 6.6, for professional application

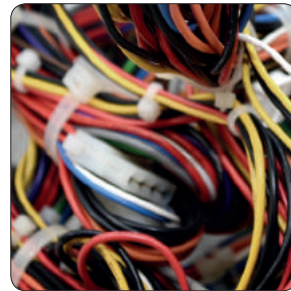

Features and benefits

- Guaranteed quality and performances by numerous approvals according to different international product standard
- Black cable ties, made of polyamide with special additives, have superior UV resistance than the natural colour ties

Technical documents

Material	polyamide 6.6
Halogen	absent
Humidity absorbtion (50% relative humidity)	2,7%
Working temperature	-40°C ÷ +85°C
Installation temperature	-10°C ÷ 60°C
Flammability rating	UL94 class V2

Resistance external agents:

Excellent chemical resistance to aromatic solvents, oils, greases, oil-based products. Good chemical resistance to bases. Limited resistance to acids. Does not resist to phenol and chlorinated solvents.

Applications

- Control panels
- Switchboards
- Electrical building Installation
- Industrial plants, automotive cable harness

Approvals and certifications

Compliant with CEI EN 62275 standard



HALOGEN FREE

STANDARD CABLE TIE NATURAL

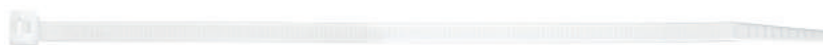

Description	Width (mm)	Length (mm)	Ø bundle max (mm)	Tensile Strength (kg)	Tensile Strength (N)	Pack (pcs.)	Code
Standard cable tie 2,5x98	2,5	98	21	8,16	80	100	5203/CE
Standard cable tie 2,5x98	2,5	98	21	8,16	80	1.000	5203E
Standard cable tie 2,5x98	2,5	98	21	8,16	80	20.000	5203/B2
Standard cable tie 2,5x135	2,5	135	32	8,16	80	100	5205/CE
Standard cable tie 2,5x135	2,5	135	32	8,16	80	1.000	5205E
Standard cable tie 2,6x160	2,6	160	40	8,16	80	100	5206/CE
Standard cable tie 2,6x200	2,6	200	52	8,16	80	100	5207/CE
Standard cable tie 2,6x200	2,6	200	52	8,16	80	1.000	5207E
Standard cable tie 3,5x140	3,5	140	32	18,36	180	100	5209/CE
Standard cable tie 3,5x140	3,5	140	32	18,36	180	1.000	5209E
Standard cable tie 3,5x200	3,5	200	50	18,36	180	100	5214/CE
Standard cable tie 3,5x200	3,5	200	50	18,36	180	1.000	5214E
Standard cable tie 3,5x290	3,5	290	80	18,36	180	100	5210/CE
Standard cable tie 3,5x290	3,5	290	80	18,36	180	500	5210E
Standard cable tie 3,5x370	3,5	370	103	18,36	180	100	5208E
Standard cable tie 4,5x160	4,5	160	40	22,44	220	100	5211/CE
Standard cable tie 4,5x160	4,5	160	40	22,44	220	1.000	5211E
Standard cable tie 4,8x178	4,8	178	45	22,44	220	100	5213/CE
Standard cable tie 4,8x178	4,8	178	45	22,44	220	1.000	5213E
Standard cable tie 4,5x200	4,5	200	50	22,44	220	100	5215/CE
Standard cable tie 4,8x200	4,8	200	50	22,44	220	1.000	5215E
Standard cable tie 4,8x250	4,8	250	68	22,44	220	100	5216/CE
Standard cable tie 4,5x290	4,5	290	78	22,44	220	100	5217E
Standard cable tie 4,5x360	4,5	360	100	22,44	220	100	5219E
Standard cable tie 4,5x390	4,5	390	106	22,44	220	100	5218E
Standard cable tie 4,5x430	4,5	430	115	22,44	220	100	5220E
Standard cable tie 7,8x180	7,8	180	45	55,08	540	100	5223E
Standard cable tie 7,8x240	7,8	240	63	55,08	540	100	5225E
Standard cable tie 7,8x300	7,8	300	80	55,08	540	100	5226E
Standard cable tie 7,5x365	7,5	365	100	55,08	540	100	5227E
Standard cable tie 7,5x450	7,5	450	130	55,08	540	100	5229E
Standard cable tie 7,5x540	7,5	540	158	55,08	540	100	5231E
Standard cable tie 7,5x750	7,5	750	220	55,08	540	100	5233E
Standard cable tie 9,0x780	9	780	233	71,4	700	100	5234E
Standard cable tie 12,5x225	12,5	225	57	110	1.080	50	5235E
Standard cable tie 12,5x500	12,5	500	143	110	1.080	50	5237E
Standard cable tie 12,5x720	12,5	720	213	110	1.080	50	5239E
Standard cable tie 12,5x850	12,5	850	255	110	1.080	50	5241E
Standard cable tie 12,5x1.000	12,5	1.000	302	110	1.080	50	5243E

Hand tools
from page 190

STANDARD CABLE TIE
BLACK

Description	Width (mm)	Length (mm)	Ø bundle max (mm)	Tensile Strength (kg)	Tensile Strength (N)	Pack (pcs.)	Code
Standard cable tie 2,5x98	2,5	98	21	8,16	80	100	5303/CE
Standard cable tie 2,5x98	2,5	98	21	8,16	80	1.000	5303E
Standard cable tie 2,5x98	2,5	98	21	8,16	80	20.000	5303/B2
Standard cable tie 2,5x135	2,5	135	32	8,16	80	100	5305/CE
Standard cable tie 2,5x135	2,5	135	32	8,16	80	1.000	5305E
Standard cable tie 2,6x160	2,6	160	40	8,16	80	100	5306/CE
Standard cable tie 2,6x200	2,6	200	52	8,16	80	100	5307/CE
Standard cable tie 2,6x200	2,6	200	52	8,16	80	1.000	5307E
Standard cable tie 3,5x140	3,5	140	32	18,36	180	100	5309/CE
Standard cable tie 3,5x140	3,5	140	32	18,36	180	1.000	5309E
Standard cable tie 3,5x200	3,5	200	50	18,36	180	100	5314/CE
Standard cable tie 3,5x200	3,5	200	50	18,36	180	1.000	5314E
Standard cable tie 3,5x290	3,5	290	80	18,36	180	100	5310/CE
Standard cable tie 3,5x290	3,5	290	80	18,36	180	500	5310E
Standard cable tie 3,5x370	3,5	370	103	18,36	180	100	5308E
Standard cable tie 4,5x160	4,5	160	40	22,44	220	100	5311/CE
Standard cable tie 4,5x160	4,5	160	40	22,44	220	1.000	5311E
Standard cable tie 4,8x178	4,8	178	45	22,44	220	100	5313/CE
Standard cable tie 4,8x178	4,8	178	45	22,44	220	1.000	5313E
Standard cable tie 4,5x200	4,5	200	50	22,44	220	100	5315/CE
Standard cable tie 4,8x200	4,8	200	50	22,44	220	1.000	5315E
Standard cable tie 4,8x250	4,8	250	68	22,44	220	100	5316/CE
Standard cable tie 4,5x290	4,5	290	78	22,44	220	100	5317E
Standard cable tie 4,5x360	4,5	360	100	22,44	220	100	5319E
Standard cable tie 4,5x390	4,5	390	106	22,44	220	100	5318E
Standard cable tie 4,5x430	4,5	430	115	22,44	220	100	5320E
Standard cable tie 7,8x180	7,8	180	45	55,08	540	100	5323E
Standard cable tie 7,8x240	7,8	240	63	55,08	540	100	5325E
Standard cable tie 7,8x300	7,8	300	80	55,08	540	100	5326E
Standard cable tie 7,5x365	7,5	365	100	55,08	540	100	5327E
Standard cable tie 7,5x450	7,5	450	130	55,08	540	100	5329E
Standard cable tie 7,5x540	7,5	540	158	55,08	540	100	5331E
Standard cable tie 7,5x750	7,5	750	220	55,08	540	100	5333E
Standard cable tie 9,0x780	9	780	233	71,40	700	100	5334E
Standard cable tie 12,5x225	12,5	225	57	110	1.080	50	5335E
Standard cable tie 12,5x500	12,5	500	143	110	1.080	50	5337E
Standard cable tie 12,5x720	12,5	720	213	110	1.080	50	5339E
Standard cable tie 12,5x850	12,5	850	255	110	1.080	50	5341E
Standard cable tie 12,5x1.000	12,5	1.000	302	110	1.080	50	5343E

Hand tools
from page 190

Easy Belturing Cable Ties

Outside serrated cable ties with low profile head and manufactured with UV-resistant polymer. Tool-free installation.

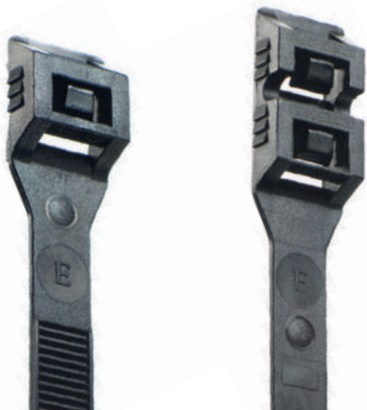

Features and benefits

- Easy insertion with low effort: maximum installation speed and important time saving
- Easy Belturing cableties can be installed without any tool: ideal for overhead lines or when working in difficult positions
- High resistance to ultraviolet radiation and in outdoor exposure conditions
- The external rack and the parallel loking system offer a smooth surface to the fastened cables avoiding any damages to the insulation
- Easy installation even at very low temperatures up to -30 ° C
- Temporary locking position allows re-opening of the ties for addition or removal of cables

Technical documents

Material	technopolymer
Halogen	absent
Humidity absorbition	<1,5%
Working temperature	-40°C ÷ 95°C
Installation temperature	-30°C ÷ 60°C
Flammability rating	UL 94 class HB

Resistance external agents:
UV-resistant. (Tested according to ISO 4892-2 : 1000h Xenon-Arc Lamp exposure). Excellent chemical resistance to aromatic solvents, oils, greases, oil-based products. Good chemical resistance to bases. Limited resistance to acids. Does not resist to phenol and chlorinated solvents.

Applications

- Electrical installation
- Industrial cables harness
- Solar energy and photovoltaic installations
- Heavy-duty outdoor cable bundling and installations

Laying instructions



Approvals and certifications

Compliant with CEI EN 62275 standard



Hand tools
from page 190

EASY BELTURING BLACK - UV-RESISTANT



Description	Width (mm)	Length (mm)	Ø bundle max (mm)	Tensile Strength (kg)	Tensile Strength (N)	Pack (pcs.)	Code
Easy belturing 8,8x180 single head	8,8	180	38	39,78	390	100	6551E
Easy belturing 8,8x270 double head	8,8	270	63	57,12	560	100	6553E
Easy belturing 8,8x360 double head	8,8	360	93	57,12	560	100	6555E

Belturing Plus

Outside serrated cable ties with low profile head and manufactured with UV-resistant polymer. For high resistance outdoor application



Features and benefits

- High resistance to ultraviolet radiation and in outdoor conditions with significant thermal excursion
- The external rack and the parallel locking system offer a smooth surface to the fastened cables avoiding any damages to the insulation
- Temporary locking position allows re-opening of the ties for addition or removal of cable
- Packed in special box, with hanging system and re-closing top, for the best using confort and protection in the jobsite

Technical documents

Material	technopolymer
Halogen	absent
Humidity absorbtion	<1%
Working temperature	-45°C ÷ 85°C
Installation temperature	-30°C ÷ 60°C
Flammability rating	UL 94 class HB

Resistance external agents:

UV-resistant. (See Approvals: Tested according to ISO 4892-2: Xenon-Arc Lamp exposure). Excellent chemical resistance to aromatic solvents, oils, greases, oil-based products. Good chemical resistance to bases. Limited resistance to acids. Does not resist to phenol and chlorinated solvents.

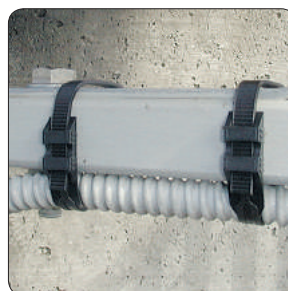

Applications

- Electrical installation
- Solar energy and photovoltaic installations
- Industrial cables harness
- Heavy-duty cable fastening and cable bundling
- In outdoor applications

Laying instructions



Approvals and certifications

Compliant with CEI EN 62275 standard



HALOGEN FREE

BELTURING PLUS SINGLE HEAD



Description	Width (mm)	Length (mm)	Ø bundle max (mm)	Tensile Strength (kg)	Tensile Strength (N)	Pack (pcs.)	Code
Belturing plus 6x115	6	115	25	28,56	280	100	6449XE
Belturing plus 6x180	6	180	45	28,56	280	100	6450XE
Belturing plus 6x290	6	290	78	28,56	280	100	6452XE
Belturing plus 6x360	6	360	100	28,56	280	100	6454XE
Belturing plus 9x132	9	132	27	39,78	390	100	6447XE
Belturing plus 9x180	9	180	40	39,78	390	100	6451XE

BELTURING PLUS DOUBLE HEAD



Description	Width (mm)	Length (mm)	Ø bundle max (mm)	Tensile Strength (kg)	Tensile Strength (N)	Pack (pcs.)	Code
Belturing plus 9x260	9	260	60	55,08	540	100	6453XE
Belturing plus 9x300	9	300	80	55,08	540	100	6448XE
Belturing plus 9x360	9	360	93	55,08	540	100	6455XE
Belturing plus 9x510	9	510	140	55,08	540	100	6456XE
Belturing plus 9x760	9	760	220	55,08	540	100	6457XE

Hand tools
from page 190

Colspeed

Outside serrated cable ties with low profile head. Manufactured in polyamide 6.6, allow installation without any tool

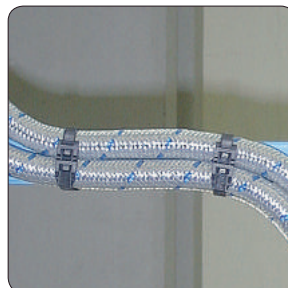

Features and benefits

- Flexible and elongated tail for reduced insertion effort
- Smooth shape, ergonomic ribbed grips for an easy installation also without any tools.
- The external rack and the parallel loking system offer a smooth surface to the fastened cables avoiding any damages to the insulation
- For using in application where high-strength performance are definitely required

Technical documents

Material	polyamide 6.6
Halogen	absent
Humidity absorbtion	2,7% (50% relative humidity)
Working temperature	-40°C ÷ 85°C
Installation temperature	-10°C ÷ 60°C
Flammability rating	UL 94 class V2

Resistance external agents:

Excellent chemical resistance to aromatic solvents, oils, greases, oil-based products. Good chemical resistance to bases. Limited resistance to acids. Does not resist to phenol and chlorinated solvents.

Applications

- Electrical installations
- Industrial and automotive cables harness
- Cable assembly in switchboards and control panels

Approvals and certifications

Compliant with CEI EN 62275 standard



HALOGEN FREE

Hand tools

from page 190

COLSPEED BLACK



Description	Width (mm)	Length (mm)	Ø bundle max (mm)	Tensile Strength (kg)	Tensile Strength (N)	Pack (pcs.)	Code
Colspeed 8,8x200 single head	8,8	200	40	40,8	400	100	6501E
Colspeed 8,8x290 double head	8,8	290	70	59,16	580	100	6502E
Colspeed 8,8x380 double head	8,8	380	100	59,16	580	100	6503E

UV-Resistant Cable Ties

Technical cable ties, in polyamide 6.6 uv-resistant, suitable for outdoor applications



Features and benefits

- Excellent resistance to ultraviolet radiation; cable ties passed the tests, for UV resistance, defined by the CEI EN 62275 standard, maintaining, after the test conditions, the 100% of the tensile declared strength (ISO 4892 - 2 - A method - 1000 hours at the xenon arc - equivalent to about 10 years of solar irradiation typical of southern European regions)
- Also suitable for installations at high operating temperatures (up to 85°C)

Technical documents

Material	polyamide 6.6.
Halogen	absent
Humidity absorbtion	2,7% (50% relative humidity)
Working temperature	-40°C ÷ 85°C
Installation temperature	-10°C ÷ 60°C
Flammability rating	UL 94 class V2

Resistance external agents:

High UV resistance (certified by DNV), excellent resistance to aromatic solvents, oils, greases, petroleum products, good resistance to bases, limited resistance to acids. Does not resist phenol and chlorinated solvents.

Applications

- Solar energy installation
- Outdoor industrial applications

Approvals and certifications

Compliant with CEI EN 62275 standard



HALOGEN FREE

Hand tools

from page 190

UV-RESISTANT BLACK



Description	Width (mm)	Length (mm)	Ø bundle max (mm)	Tensile Strength (kg)	Tensile Strength (N)	Pack (pcs.)	Code
UV-resistant cable tie 2,5x98	2,5	98	21	8,16	80	100	5303/C UVE
UV-resistant cable tie 3,5x140	3,5	140	32	13,26	130	100	5309/C UVE
UV-resistant cable tie 3,5x200	3,5	200	50	18,36	130	100	5314/C UVE
UV-resistant cable tie 4,8x200	4,8	200	50	22,44	220	100	5315/C UVE
UV-resistant cable tie 4,5x290	4,5	290	78	22,44	220	100	5317 UVE
UV-resistant cable tie 7,5x365	7,5	365	100	55,08	540	100	5327 UVE

Heat Resistant Cable Ties

Technical cable ties, suitable for high temperature applications, up to 150°C



Hand tools
from page 190

Features and benefits

- High temperatures resistance: up to 125°C in continuous, up to 150°C for 500 h.

Technical documents

Material	polyamide 6.6 with additives
Halogen	absent
Humidity absorption	2,7% (50% relative humidity)
Working temperature	from -40°C to 125°C
Installation temperature	-10°C ÷ 60°C
Flammability rating	UL 94 class V2

Resistance external agents:
Resistant to high temperatures. Excellent chemical resistance to aromatic solvents, oils, greases, oil-based products. Good chemical resistance to bases. Limited resistance to acids. Does not resist to phenol and chlorinated solvents.

Applications

- Automotive wiring harness in engine compartments
- Industrial high temperature cabling

Approvals and certifications

Compliant with CEI EN 62275 standard



HEAT RESISTANT CABLE TIE NATURAL



Description	Width (mm)	Length (mm)	Ø bundle max (mm)	Tensile Strength (kg)	Tensile Strength (N)	Pack (pcs.)	Code
Heat resistant cable tie 2,5x98	2,5	98	21	8,16	80	100	5203/C TE
Heat resistant cable tie 3,5x140	3,5	140	32	18,36	180	100	5209/C TE
Heat resistant cable tie 3,5x200	3,5	200	50	18,36	180	100	5214/C TE
Heat resistant cable tie 4,8x200	4,8	200	50	22,44	220	100	5215/C TE
Heat resistant cable tie 4,5x290	4,5	290	78	22,44	220	100	5217 TE
Heat resistant cable tie 7,5x365	7,5	365	100	55,08	540	100	5227 TE

HEAT RESISTANT CABLE TIE BLACK



Description	Width (mm)	Length (mm)	Ø bundle max (mm)	Tensile Strength (kg)	Tensile Strength (N)	Pack (pcs.)	Code
Heat resistant cable tie 2,5x98	2,5	98	21	8,16	80	100	5303/C TE
Heat resistant cable tie 3,5x140	3,5	140	32	18,36	180	100	5309/C TE
Heat resistant cable tie 3,5x200	3,5	200	50	18,36	180	100	5314/C TE
Heat resistant cable tie 4,8x200	4,8	200	50	22,44	220	100	5315/C TE
Heat resistant cable tie 4,5x290	4,5	290	78	22,44	220	100	5317 TE
Heat resistant cable tie 7,5x365	7,5	365	100	55,08	540	100	5327 TE

Self-Extinguishing Cable Ties

Self-extinguishing cable ties, in polyamide VO, for higher fire protection. Halogen and phosphorus free



Features and benefits

- Manufactured in self-extinguish polyamide with extremely low toxic gas emission in fire situations
- Good flammability behaviour

Technical documents

Material	polyamide 6.6 with additives
Halogen	absent
Humidity absorbtion	2,7% (50% relative humidity)
Working temperature	-40°C ÷ 85°C
Installation temperature	-10°C ÷ 60°C
Flammability rating	UL 94 class VO - GW 960°C

Resistance external agents:
Excellent flammability behaviour (UL94 VO). Excellent chemical resistance to aromatic solvents, oils, greases, oil-based products. Good chemical resistance to bases. Limited resistance to acids. Does not resist to phenol and chlorinated solvents.

Applications

- Rolling stock wiring harness, cable bundling in ship building and marine installations
- Underground electrical installations
- Electrical cables harness in tunnels
- Wiring harness with fire protection in civil, commercial and industrial building (cinemas, theatres, hospitals, schools)

Approvals and certifications

Compliant with CEI EN 62275 standard

Certificate according to UNI EN 45545-2: 2015 (concerning railway applications - Fire protection on railway vehicles and requirements for materials and components fire behaviours in the railway sector)



Hand tools
from page 190

SELF-EXTINGUISHING CABLE TIE WHITE



Description	Width (mm)	Length (mm)	Ø bundle (mm)	Tensile Strength (kg)	Tensile Strength (N)	Pack (pcs.)	Code
Self-extinguishing cable tie 2,5x98	2,5	98	21	8,16	80	100	5203/C VOE
Self-extinguishing cable tie 3,5x140	3,5	140	32	18,36	180	100	5209/C VOE
Self-extinguishing cable tie 3,5x200	3,5	200	50	18,36	180	100	5214/C VOE
Self-extinguishing cable tie 4,8x200	4,8	200	50	22,44	220	100	5215/C VOE
Self-extinguishing cable tie 4,5x290	4,5	290	78	22,44	220	100	5217 VOE
Self-extinguishing cable tie 7,5x365	7,5	365	100	55,08	540	100	5227 VOE

Detectable Cable Ties

Detectable cable ties for food and pharmaceutical industries



Features and benefits

- The inclusion of an iron oxide additive in the polyamide material enables cable ties or related small sections to be detected by the metal detectors or X-ray inspection systems
- The blue colour allows an easy visual inspection and detection
- Use of detectable cable ties in plants installation, machines cabling and maintenance allows the agro-food and pharmaceutical industries to comply with the Hazard Analysis Critical Control Points principles (HACCP). This preventive approach is implemented to identify and eliminate potential hazard and contaminations in the food production processes

Technical documents

Material	polyamide 6.6 with iron oxide
Halogen	absent
Humidity absorbtion	2,7% (50% relative humidity)
Working temperature	-40°C ÷ 85°C
Installation temperature	-5°C ÷ 60°C
Flammability rating	UL 94 class HB

Not suitable for food contact

Resistance external agents:
Excellent chemical resistance to aromatic solvents, oils, greases, oil-based products. Good chemical resistance to bases. Limited resistance to acids. Does not resist to phenol and chlorinated solvents.

Applications

- Cables bundling, cable harness and machine cables assembly and maintenance into the agro-food and pharmaceutical processing industries.

Approvals and certifications

Compliant with CEI EN 62275 standard



HALOGEN FREE

Hand tools
from page 190

DETECTABLE CABLE TIE BLUE



Description	Width (mm)	Length (mm)	Ø bundle max (mm)	Tensile Strength (kg)	Tensile Strength (N)	Pack (pcs.)	Code
Detectable cable tie 2,5x98	2,5	98	21	8,16	80	100	5203/C DTE
Detectable cable tie 3,5x140	3,5	140	32	13,26	130	100	5209/C DTE
Detectable cable tie 3,5x200	3,5	200	50	13,26	130	100	5214/C DTE
Detectable cable tie 4,5x200	4,5	200	50	22,44	220	100	5215/C DTE
Detectable cable tie 4,5x290	4,5	290	78	22,44	220	100	5217 DTE
Detectable cable tie 4,5x360	4,5	360	100	22,44	220	100	5219 DTE
Detectable cable tie 7,5x365	7,5	365	100	55,08	540	100	5227 DTE

Coloured Cable Ties

Technical cable ties, in colored polyamide 6.6, for an easy identification or differentiation

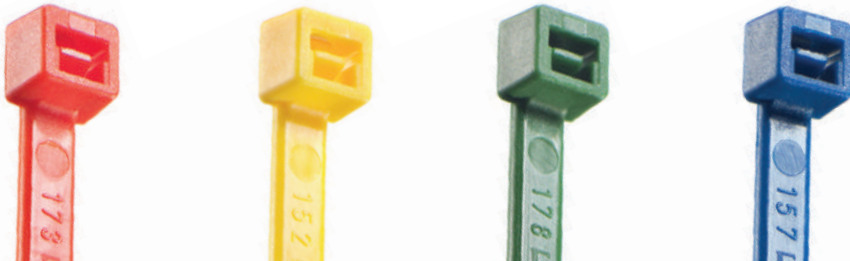

Features and benefits

- Available in four colours: red, yellow, green, blue

Technical documents

Material	polyamide 6.6 added with coloured master
Halogen	absent
Humidity absorption	2,7% (50% relative humidity)
Working temperature	-40°C ÷ 85°C
Installation temperature	-10°C ÷ 60°C
Flammability rating	UL 94 class HB

Resistance external agents:
Excellent chemical resistance to aromatic solvents, oils, greases, oil-based products. Good chemical resistance to bases. Limited resistance to acids. Does not resist to phenol and chlorinated solvents.

Applications

- Electrical installation
- Industrial cable harness, switchboards
- Logistic
- Packaging and special applications

Approvals and certifications

Compliant with CEI EN 62275 standard



HALOGEN FREE

Hand tools
from page 190

COLOURED CABLE TIE

Description	Color	Width (mm)	Length (mm)	Ø bundle max (mm)	Tensile Strength (kg)	Tensile Strength (N)	Pack (pcs.)	Code
Coloured cable tie 2,5x98 red	●	2,5	98	21	8,16	80	100	5203/C RE
Coloured cable tie 3,5x140 red	●	3,5	140	32	18,36	180	100	5209/C RE
Coloured cable tie 3,5x200 red	●	3,5	200	50	18,36	180	100	5214/C RE
Coloured cable tie 4,8x200 red	●	4,8	200	50	22,44	220	100	5215/C RE
Coloured cable tie 4,5x290 red	●	4,5	290	78	22,44	220	100	5217 RE
Coloured cable tie 2,5x98 yellow	●	2,5	98	21	8,16	80	100	5203/C GE
Coloured cable tie 3,5x140 yellow	●	3,5	140	32	18,36	180	100	5209/C GE
Coloured cable tie 3,5x200 yellow	●	3,5	200	50	18,36	180	100	5214/C GE
Coloured cable tie 4,8x200 yellow	●	4,8	200	50	22,44	220	100	5215/C GE
Coloured cable tie 4,5x290 yellow	●	4,5	290	78	22,44	220	100	5217 GE
Coloured cable tie 2,5x98 green	●	2,5	98	21	8,16	80	100	5203/C VE
Coloured cable tie 3,5x140 green	●	3,5	140	32	18,36	180	100	5209/C VE
Coloured cable tie 3,5x200 green	●	3,5	200	50	18,36	180	100	5214/C VE
Coloured cable tie 4,8x200 green	●	4,8	200	50	22,44	220	100	5215/C VE
Coloured cable tie 4,5x290 green	●	4,5	290	78	22,44	220	100	5217 VE
Coloured cable tie 2,5x98 blue	●	2,5	98	21	8,16	80	100	5203/C BE
Coloured cable tie 3,5x140 blue	●	3,5	140	32	18,36	180	100	5209/C BE
Coloured cable tie 3,5x200 blue	●	3,5	200	50	18,36	180	100	5214/C BE
Coloured cable tie 4,8x200 blue	●	4,8	200	50	22,44	220	100	5215/C BE
Coloured cable tie 4,5x290 blue	●	4,5	290	78	22,44	220	100	5217 BE

Identification Ties with Plate

Technical cable ties with identification plate allow bundles and cabling to be easily marked and identified



Features and benefits

- Ideal for electrical wiring, bundles and in the cabling applications
- Transversal, longitudinal or external identification plate can be easily marked with label or a permanent marker and allows bundles or cables to be easily identified

Technical documents

Material	polyamide 6.6
Halogen	absent
Humidity absorption	2,7% (50% relative humidity)
Working temperature	-40°C ÷ 85°C
Installation temperature	-10°C ÷ 60°C
Flammability rating	UL 94 class V2

Resistance external agents:

Excellent chemical resistance to aromatic solvents, oils, greases, oil-based products. Good chemical resistance to bases. Limited resistance to acids. Does not resist to phenol and chlorinated solvents.

Applications

- Electrical installation
- Industrial cable harness
- Switchboards
- Automotive wiring harness
- Other special applications

Approvals and certifications

Compliant with CEI EN 62275 standard



IDENTIFICATION CABLE TIE



Description	Width (mm)	Length (mm)	Ø bundle max (mm)	Plate height (mm)	Plate width (mm)	Tensile Strength (kg)	Tensile Strength (N)	Pack (pcs.)	Code
Identification cable tie transversal plate 2,5x100	2,5	100	20	8	25,4	8,16	80	100	52100-ME
Identification cable tie transversal plate 2,5x200	2,5	200	50	8	25,4	8,16	80	100	52200-ME
Identification cable tie longitudinal plate 4,8x190	4,8	190	50	28	13	22,44	220	100	52190-ME
Identification cable tie longitudinal plate 4,8x270	4,8	270	75	28	13	22,44	220	100	52270-ME
Identification cable tie external plate 2,5x110	2,5	110	20	9,1	20,4	8,16	80	100	52110-ME
Identification cable tie external plate 2,5x210	2,5	210	52	9,1	20,4	8,16	80	100	52210-ME

Fixing Cable Ties

Fixing ties with screw mount head or arrowhead anchoring allow to fix bundles and cabling to panels or to different supports by screws, bolts, or rivets



Features and benefits

- Fixing ties with arrowhead anchoring for fastening bundles or cable to panels up to 3 mm thickness
- Fixing ties with screw mount head for fastening bundles or cable to any surface. The possibility of using screws, bolts or rivets offers flexibility and strong fixation to any supports

Technical documents

Material	polyamide 6.6
Halogen	absent
Humidity absorbtion	2,7% (50% relative humidity)
Working temperature	-40°C ÷ 85°C
Installation temperature	-10°C ÷ 60°C
Flammability rating	UL 94 class V2

Resistance external agents:

Excellent chemical resistance to aromatic solvents, oils, greases, oil-based products. Good chemical resistance to bases. Limited resistance to acids. Does not resist to phenol and chlorinated solvents.

Applications

- Electrical installation
- Industrial cables harness
- Switchboards
- Automotive wiring harness
- Other special applications

Approvals and certifications

Compliant with CEI EN 62275 standard



HALOGEN FREE

ARROWHEAD CABLE TIE

NATURAL



Description	Width (mm)	Length (mm)	Ø bundle max (mm)	Ø hole	Panel thickness	Tensile Strength (kg)	Tensile Strength (N)	Pack (pcs.)	Code
Arrowhead cable tie 3,5x150	3,5	150	38	5,5	2,7	13,26	130	100	52155-ME
Arrowhead cable tie 3,5x200	3,5	200	50	5,5	2,7	13,26	130	100	52199-ME
Arrowhead cable tie 4,5x200	4,5	200	50	6,3	3	22,44	220	100	52205-ME

SCREW MOUNT CABLE TIE

NATURAL



Description	Width (mm)	Length (mm)	Ø bundle max (mm)	Ø hole (mm)	Tensile Strength (kg)	Tensile Strength (N)	Pack (pcs.)	Code
Screw mount cable tie 3,5x150	3,5	150	32	4,4	13,26	130	100	52150-IE
Screw mount cable tie 3,5x200	3,5	200	49	4,4	13,26	130	100	52200-IE
Screw mount cable tie 4,5x150	4,5	150	32	5,4	22,44	220	100	52150-SE
Screw mount cable tie 4,5x200	4,5	200	47	5,4	22,44	220	100	52200-SE
Screw mount cable tie 7,5x200	7,5	200	44	6	55,08	540	100	52200-HE
Screw mount cable tie 7,5x300	7,5	300	75	6	55,08	540	100	52300-HE

Releasable Cable Ties

Releasable and reusable cable ties, suitable for temporary bundling and when open-close function is necessary in different industrial and commercial applications



Features and benefits

- The release mechanism allows easy and manual opening of the ties.
- Opened ties can be reused for new fastenings

Technical documents

Material	polyamide 6.6
Halogen	absent
Humidity absorbtion	2,7% (50% relative humidity)
Working temperature	-40°C ÷ 85°C
Installation temperature	-10°C ÷ 60°C
Flammability rating	UL 94 class V2

Resistance external agents:
Excellent chemical resistance to aromatic solvents, oils, greases, oil-based products. Good chemical resistance to bases. Limited resistance to acids. Does not resist to phenol and chlorinated solvents.

Applications

- Electrical installation
- Industrial cables harness
- Switchboards
- Automotive wiring harness
- Other special applications

Approvals and certifications

Compliant with CEI EN 62275 standard



HALOGEN FREE

RELEASABLE CABLE TIE NATURAL



Description	Width (mm)	Length (mm)	Ø bundle max (mm)	Tensile Strength (kg)	Tensile Strength (N)	Pack (pcs.)	Code
Releasable tie 7,5x200	7,5	200	50	22,44	220	100	5250E
Releasable tie 7,5x250	7,5	250	65	22,44	220	100	5252E
Releasable tie 7,5x350	7,5	350	100	22,44	220	100	5254E

RELEASABLE CABLE TIE BLACK



Description	Width (mm)	Length (mm)	Ø bundle max (mm)	Tensile Strength (kg)	Tensile Strength (N)	Pack (pcs.)	Code
Releasable tie 7,5x200	7,5	200	50	22,44	220	100	5350E
Releasable tie 7,5x250	7,5	250	65	22,44	220	100	5352E
Releasable tie 7,5x350	7,5	350	100	22,44	220	100	5354E

EASY BELTURING

THE **PERFECT**
CABLE TIE
FOR **OUTDOOR**
APPLICATION



TIME SAVINGS

The application time is **at least 1/3** less compared to competitors' ties.



HIGH RESISTANCE TO UV RAYS

High **resistance to UV** rays (ISO 4892-2 test).



LOW INSERTION EFFORT

thanks to the material characteristics and the tie structure.



THE BEST PERFORMANCES

Very high resistance to atmospheric agents, high operating temperature, **superior mechanical strength**.



EASY TO INSTALL

It can be installed **without tools**.
Easy tightening even in **uncomfortable positions**.



Colsteel

Completely stainless steel cable tie, with high mechanical strength, resistant to the fire and corrosion



Features and benefits

- Quick installation, by manual tightening and tensioning with the specific tool
- The ball locking mechanism and the smooth surface offer a very low insertion effort and an infinitely calibrated closing adjustment along all the length of the tie
- High mechanical strength: for safety and high performance applications, which can be guaranteed, only with a metal tie
- The total-smooth profiles and surfaces avoid any damage to the insulation of the electrical cables to be bundled
- Fire resistant, suitable for very high operating temperatures
- Maximum resistance to ultraviolet rays exposure
- Available in 304 and also in 316 stainless steel grade for the highest corrosion and chemical resistance

Technical documents

Material	stainless steel INOX AISI 304 and 316
Working temperature	-80°C ÷ 538°C
	Not inflammable

Resistance external agents:

Excellent resistance to acids, oils, greases, oil-based products, chemical and oxidizing agents, solvents. High resistance in salt mist atmosphere. Corrosion resistant. UV-resistant



Applications

- Fastening and bundling of cables and pipes in hard environments like oil rigs off-shore installations, oil pipelines, chemical plants, ship buildings, mining
- Different electrical installation for fire protections, solar thermal and photovoltaic installations subjected to higher solar exposure or adverse climatic conditions

Approvals and certifications

Compliant with CEI EN 62275 standard



HALOGEN FREE

COLSTEEL
AISI 304

Description	Width (mm)	Length (mm)	Ø bundle max (mm)	Tensile Strength (kg)	Tensile Strength (N)	Pack (pcs.)	Code
Colsteel 4,6x127 - AISI 304	4,6	127	25	91,8	900	100	6701
Colsteel 4,6x201 - AISI 304	4,6	201	51	91,8	900	100	6703
Colsteel 4,6x266 - AISI 304	4,6	266	69	91,8	900	100	6706
Colsteel 4,6x362 - AISI 304	4,6	362	102	91,8	900	100	6708
Colsteel 4,6x521 - AISI 304	4,6	521	152	91,8	900	50	6710
Colsteel 4,6x838 - AISI 304	4,6	838	254	91,8	900	50	6712
Colsteel 7,9x201 - AISI 304	7,9	201	51	204	2.000	100	6719
Colsteel 7,9x266 - AISI 304	7,9	266	69	204	2.000	100	6720
Colsteel 7,9x362 - AISI 304	7,9	362	102	204	2.000	100	6722
Colsteel 7,9x521 - AISI 304	7,9	521	152	204	2.000	50	6724
Colsteel 7,9x838 - AISI 304	7,9	838	254	204	2.000	50	6726
Colsteel 7,9x1.067 - AISI 304	7,9	1.067	304	204	2.000	50	6728

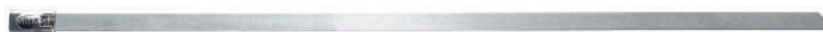
COLSTEEL
AISI 316

Description	Width (mm)	Length (mm)	Ø bundle max (mm)	Tensile Strength (kg)	Tensile Strength (N)	Pack (pcs.)	Code
Colsteel 4,6x201 - AISI 316	4,6	201	51	91,8	900	100	6753
Colsteel 4,6x266 - AISI 316	4,6	266	69	91,8	900	100	6756
Colsteel 4,6x362 - AISI 316	4,6	362	102	91,8	900	100	6758
Colsteel 4,6x521 - AISI 316	4,6	521	152	91,8	900	50	6760
Colsteel 7,9x201 - AISI 316	7,9	201	51	204	2000	100	6769
Colsteel 7,9x266 - AISI 316	7,9	266	69	204	2000	100	6770
Colsteel 7,9x362 - AISI 316	7,9	362	102	204	2000	100	6772

Hand tools
from page 191

Anchoring Base for Cable Ties

Polyamide anchoring base for cable ties, for fixing to different building materials. To be used with any cable tie up to 9mm wide



5458E



5459E
SPACED



5456 AE - 5458 AE
WITH WINGS

Base materials



Technical documents

Material	polyamide 6 - nero
Halogen	absent
Humidity absorption (50% relative humidity)	3,0 %
Working temperature	-10°C ÷ 65°C
Min. Installation temperature	-5°C
Flammability rating	UL94 class V2
Resistance external agents:	
Excellent chemical resistance to aromatic solvents, oils, greases, oil-based products. Good chemical resistance to bases. Limited resistance to acids. Does not resist to phenol and chlorinated solvents.	

Applications

- Light-duty anchoring base for fastening cables and pipes, by cable ties, in civil, commercial and industrial electrical installations

Installation

- Push directly into the drilled hole. The fixing immediately wedges in the building material

Approvals and certifications

Compliant with CEI EN 62275 standard

HALOGEN FREE

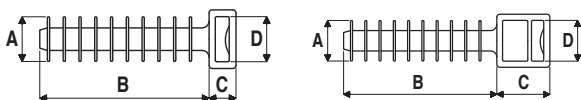

Description	ø hole (mm)	ø anchor (mm)	Embedment depth (mm)	Height (mm)	Width (mm)	Tensile Strength (kg)	Tensile Strength (N)	Pack (pcs.)	Code
		A	B	C	D				
Anchor base for cable tie ø6 x h. 6,3 - w/wings	6	7,8	31	6,3	9,6	55,08	540	100	5456 AE
Anchor base for cable tie ø8 x h. 6,5	8	10	37	6,5	9,7	55,08	540	100	5458E
Anchor base for cable tie ø8 x h. 6,5 - w/wings	8	10	37	6,5	9,7	55,08	540	100	5458 AE
Anchor base for cable tie ø8 x h. 13	8	10	37	13	9,7	55,08	540	100	5459E

Threaded Fixing Base for Cable Ties

Threaded base M6/7 suitable for cable ties up to 9mm wide. To be fixed, by metric-head plugs, to different building supports

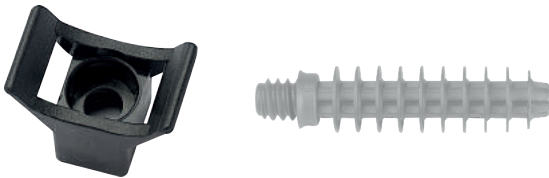

Base materials



Technical documents

Material	polyamide 6 - black/gray
Halogen	absent
Humidity absorption (50% relative humidity)	3,0 %
Working temperature	-10°C ÷ 65°C
Min. installation temperature	-5°C
Flammability rating	UL94 class V2
Resistance external agents:	
Excellent chemical resistance to aromatic solvents, oils, greases, oil-based products. Good chemical resistance to bases. Limited resistance to acids. Does not resist to phenol and chlorinated solvents.	

Applications

- For fixing, by metric-head plugs, to solid building materials (concrete, solid brick, etc.)

Installation

- Screw directly to pre-installed plugs, anchors or screws having metric threaded head

Approvals and certifications

Compliant with CEI EN 62275 standard

HALOGEN FREE

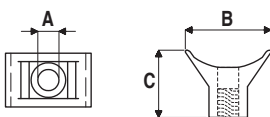

Description	ø hole (mm)	Length (mm)	Height (mm)	Tensile Strength (kg)	Tensile Strength (N)	Max. cable tie width (mm)	Pack (pcs.)	Code
	A	B	C					
Threaded fixing base for cable ties 5x23	5	23	17,6	40,8	400	9	100	1041301E



Description	ø hole (mm)	Thread	Embedment depth (mm)	Pack (pcs.)	Code
Threaded pivot M7/8x37	8	M7	37	100	565940

Fixing Cradle

Polyamide 6.6 fixing cradle for ties up to 7,8 width, to secure cable and pipes on different panels



Applications

- Fixing to boards (plastic, sheet-steel) with a maximum thickness of 3 mm

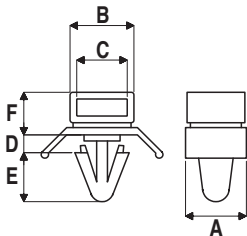

Installation

- Install directly in pre-drilled or punched \varnothing 6,5 mm holes

Approvals and certifications

Compliant with CEI EN 62275 standard

HALOGEN FREE

Description	\varnothing hole (mm)	A (mm)	B (mm)	C (mm)	D (mm)	E (mm)	F (mm)	Tensile Strength (kg)	Tensile Strength (N)	Max cable tie width (mm)	Max panel thickness (mm)	Pack (pcs.)	Code
Fixing cradle	6,5	10	10,6	8,1	3	8	7,7	55,08	540	7,8	3	100	104300

Mounting Base

Mounting base, in polyamide 6.6, to secure cables and pipes, by cable ties up to 9 mm width. For fixing to boards with countersunk screws or rivets



Installation

- Fix the base by screws or rivet and secure cables or pipes by the right cable ties

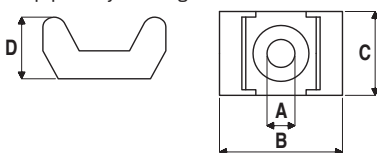

Approvals and certifications

Compliant with CEI EN 62275 standard

HALOGEN FREE

Description	\varnothing hole (mm)	Length (mm)	Width (mm)	Height (mm)	Tensile Strength (kg)	Tensile Strength (N)	Max. cable tie width (mm)	Color	Pack (pcs.)	Code
	A	B	C	D						
Mounting base 3,5x15,8x10,3	4	15,8	10,3	7	22,44	220	5	●	100	5498
Mounting base 3,5x15,8x10,3	4	15,8	10,3	7	22,44	220	5	●	100	5499
Mounting base 5x22,5x14,6	5	22,5	14,6	11	71,4	700	9	●	100	5496E
Mounting base 5x22,5x14,6	5	22,5	14,6	11	71,4	700	9	●	100	5497E

Screw Fixing Mounts

Screw fixing mount in polyamide 6.6, to secure cables and pipes, by cable ties up to 4,8 mm width. For fixing to boards with countersunk screws or rivets



Applications

- Fixed by screws, rivets or bolts to boards, the base provides a simple and compact support for fastening cables with ties into switchgears and cabinets

Installation

- Fix the base by screws, rivets or bolts and secure cables or pipes by cable ties.

Approvals and certifications

Compliant with CEI EN 62275 standard

HALOGEN FREE

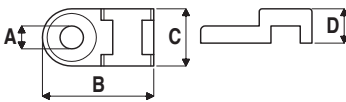

Description	∅ hole (mm)	Length (mm)	Width (mm)	Height (mm)	Tensile Strength (kg)	Tensile Strength (N)	Max. cable tie width (mm)	Pack (pcs.)	Code
	A	B	C	D					
Screw fixing mount 4,1x19x10	4,1	19	10	6	22,44	220	4,8	100	5460E

Two-way Mounting Bases

Bi-directional mounts, in ABS material, white or black colour, self-adhesive or for screw fixing

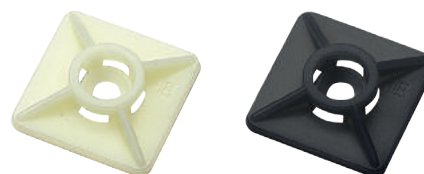

Features and benefits

- Available for two different mounting, these bases allow a simple, flexible and safe fastening by cable ties up to 4,8 mm width
- The syntetic rubber adhesive ensures a very fast adhesiveness, allowing an immediate fixing of the cables and pipes.
- The acrylate adhesive, which ensures very high pull-off performances after 24 hours, allows the mounts to be used for long-term and heavy applications, even when exposed to high temperatures

Applications

- Fastening of cables or bundles with ties into electrical switchgears and cabinets and in a wide variety of indoor application

Technical documents

Material	ABS
Halogen	absent
Working temperature	-10°C ÷ 60°C
Flammability rating	UL94 class HB

Installation

- Screw fixing mounts: to be fixed with screws, bolts, rivets or additional adhesive supports
- Self-adhesive mounts - acrylate: to be loaded after 24 hours from installation
- For a secure installation of the self-adhesive mounts, the surfaces must be carefully cleaned and degreased with solvent (alcohol or other cleaning product)

Approvals and certifications

Compliant with CEI EN 62275 standard

HALOGEN FREE

ADHESIVE PROPERTIES

Type of support	Rubber base - Polyethylene	Acrylic base - Polyurethane
Density	85 Kg/cm ³	320 Kg/cm ³
100 hour static shear adhesion*	0,7 kg/cm ²	0,6 kg/cm ²
Tensile strength	10 kg/cm ²	16,5 kg/cm ²
U.V. Resistance	not recommended	good
Working temperature	-40 °C ÷ 60 °C	-40 °C ÷ 90 °C
Recommended application temperature	18 °C ÷ 35 °C	18 °C ÷ 35 °C
Stocking temperature	18 °C ÷ 30 °C	18 °C ÷ 30 °C
Shelf life	12 months	24 months
Use	immediate application	application after 24h rest

* On degreased and dry galvanized metal surface

MOUNTING BASES ADHESIVITY

Maximum static load recommended	Rubber base adhesive	Acrylic base adhesive
Dimensions 19x19 mm	125 gr	150 gr
Dimensions 27x27 mm	300 gr	300 gr

INSTALLATION INSTRUCTIONS



Clean the surface using an appropriate cleaner and wait until completely dried.



Peel off the protective film avoiding touching the adhesive.



Apply the base on the surface pressing down for few seconds.



For the best results wait time indicated in the technical table.

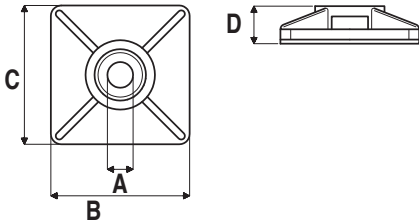

TWO-WAY MOUNTING BASE WITHOUT ADHESIVE

Description	∅ hole (mm)	Length (mm)	Width (mm)	Height (mm)	Tensile Strength (kg)	Tensile Strength (N)	Max. cable tie width (mm)	Color	Pack (pcs.)	Code
	A	B	C	D						
Two-way mounting base 4,8x27x27 natural	4,8	27	27	6,5	18,36	180	4,8	○	100	5472E
Two-way mounting base 4,8x27x27 black	4,8	27	27	6,5	18,36	180	4,8	●	100	5474E

TWO-WAY MOUNTING BASE WITH RUBBER BASE ADHESIVE

Description	∅ hole (mm)	Length (mm)	Width (mm)	Height (mm)	Tensile Strength (kg)	Tensile Strength (N)	Max. cable tie width (mm)	Color	Pack (pcs.)	Code
	A	B	C	D						
Two-way mounting base 4,1x19x19 natural	4,1	19	19	5	10,20	100	3,6	○	100	5467 RBE
Two-way mounting base 4,1x19x19 black	4,1	19	19	5	10,20	100	3,6	●	100	5469 RBE
Two-way mounting base 4,8x27x27 natural	4,8	27	27	6,5	18,36	180	4,8	○	100	5473 RBE
Two-way mounting base 4,8x27x27 black	4,8	27	27	6,5	18,36	180	4,8	●	100	5475 RBE

TWO-WAY MOUNTING BASE WITH ACRYLIC BASE ADHESIVE

Description	∅ hole (mm)	Length (mm)	Width (mm)	Height (mm)	Tensile Strength (kg)	Tensile Strength (N)	Max. cable tie width (mm)	Color	Pack (pcs.)	Code
	A	B	C	D						
Two-way mounting base 4,1x19x19 natural	4,1	19	19	5	10,20	100	3,6	○	100	5467 3MVE
Two-way mounting base 4,1x19x19 black	4,1	19	19	5	10,20	100	3,6	●	100	5469 3MVE
Two-way mounting base 4,8x27x27 natural	4,8	27	27	6,5	18,36	180	4,8	○	100	5473 3MVE
Two-way mounting base 4,8x27x27 black	4,8	27	27	6,5	18,36	180	4,8	●	100	5475 3MVE

Detectable Two-way Mounting Bases

Bi-directional self-adhesive mounts.
Detectable by metal detecting and X-ray equipments



Features and benefits

- The iron oxide added into polyamide 6.6 offer an excellent detectability allowing the use in the food and pharmaceutical processing plants
- The reduced curing time of synthetic rubber adhesive allows immediate fastening and loading of cables and bundles

Applications

- Electrical installations and other fastening in Pharmaceutical and agri-food processing plants

Technical documents

Material	polyamide 6.6 blue with iron oxide
Halogen	absent
Working temperature	-5°C ÷ 60°C
Flammability rating	UL94 class HB

Installation

- For a secure installation of the self-adhesive mounts, the surfaces must be carefully cleaned and degreased with solvent (alcohol or other cleaning product)

Approvals and certifications

Compliant with CEI EN 62275 standard

HALOGEN FREE

For the adhesive technical characteristics and the application methods, see page 38

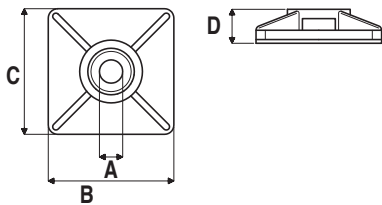

DETECTABLE TWO-WAY MOUNTING BASE

Description	ø hole (mm)	Length (mm)	Width (mm)	Height (mm)	Tensile Strength (kg)	Tensile Strength (N)	Max. cable tie width (mm)	Color	Pack (pcs.)	Code
	A	B	C	D						
Detectable two-way mounting base 4,8x27x27	4,8	27	27	6,5	18,36	180	4,8	●	100	5473DT RBE

Self-adhesive Fixing Clips for Round Cables

Self-adhesive clips in polyamide, natural or black colour, with acrylate or synthetic rubber based adhesives, for easy fastening of round cables



Features and benefits

- The synthetic rubber adhesive ensures a very fast adhesiveness, allowing an immediate fixing of the cables and pipes.
- The acrylate adhesive, which ensures very high pull-off performances after 24 hours, allows the mounts to be used for long-term and heavy applications, even when exposed to high temperatures

Applications

- For the indoor fastening of cables into switchgears and control cabinets

Technical documents

Material	polyamide 6.6
Halogen	absent
Working temperature	-40°C ÷ 85°C
Flammability rating	UL94 class V2

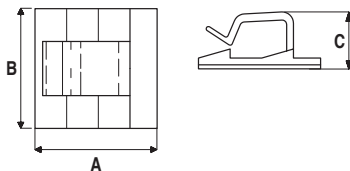

Installation

- Self-adhesive clips - acrylate: to be loaded after 24 hours from installation
- For a secure installation of the self-adhesive clips, the surfaces must be carefully cleaned and degreased with solvent (alcohol or other cleaning product)

Approvals and certifications

HALOGEN FREE

For the adhesive technical characteristics and the application methods, see page 38

CABLE CLIPS WITH RUBBER BASE ADHESIVE

Description	Length (mm) A	Width (mm) B	Height (mm) C	Color	Pack (pcs.)	Code
Self-adhesive fixing clip for round cables 19x19x5 natural	19	19	5	○	100	5430 RBE
Self-adhesive fixing clip for round cables 19x19x5 black	19	19	5	●	100	5431 RBE
Self-adhesive fixing clip for round cables 26x26x8 natural	26	26	8	○	100	5432 RBE
Self-adhesive fixing clip for round cables 26x26x8 black	26	26	8	●	100	5433 RBE
Self-adhesive fixing clip for round cables 26x26x15 natural	26	26	15	○	100	5436 RBE
Self-adhesive fixing clip for round cables 26x26x15 black	26	26	15	●	100	5439 RBE

CABLE CLIPS WITH ACRYLIC BASE ADHESIVE

Description	Length (mm) A	Width (mm) B	Height (mm) C	Color	Pack (pcs.)	Code
Self-adhesive fixing clip for round cables 19x19x5 natural	19	19	5	○	100	5430 3MVE
Self-adhesive fixing clip for round cables 26x26x12 natural	26	26	12	○	100	5432 3MVE
Self-adhesive fixing clip for round cables 26x26x15 natural	26	26	15	○	100	5436 3MVE

Self-adhesive Clips for Flat Cables

Self-adhesive clips in polyvinylchloride (PVC), with rubber based adhesive, for fixing of flat cables



Features and benefits

- The synthetic rubber adhesive ensures a very fast adhesiveness, allowing an immediate fixing of the cables and pipes

Installation

- For a secure installation of the self-adhesive Clips, the surfaces must be carefully cleaned and degreased with solvent (alcohol or other cleaning product)

Technical documents

Material	PVC
Working temperature	-10°C ÷ 70°C
Flammability rating	UL94 class V0

Applications

- For the indoor fastening of cables into switchgears and control cabinets

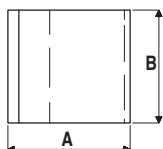
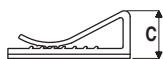

For the adhesive technical characteristics and the application methods, see page 38

ADHESIVE CABLE CLIP FOR FLAT CABLE

Description	Length (mm)	Width (mm)	ø cable (mm)	Color	Pack (pcs.)	Code
	A	B	C			
Self-adhesive clip for flat cables 26x20x9,6	26	20	9,6	○	100	AFC-20
Self-adhesive clip for flat cables 26x25x9,6	26	25	9,6	○	100	AFC-25
Self-adhesive clip for flat cables 26x30x9,6	26	30	9,6	○	50	AFC-30

Cable Clips

Cable clip in polyethylene, high temperatures resistant, white colour, with hardened and galvanized steel nail



Features and benefits

- Easy installation thanks to the hammer-in application
- High Resistant steel nails

Applications

- Fixing of electric cables on masonry and wooden supports

Technical documents

Material	High-density polyethylene with high thermic resistance
Working temperature	-40°C ÷ 100°C
Flammability rating	UL94 class V2

Approvals and certifications

HALOGEN FREE

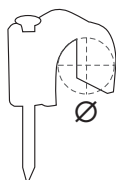

CABLE CLIP FOR ROUND CABLE

Description	∅ cable (mm)	Cable type (nr.cond x mm²)	Nail dimension (mm)	Pack (pcs.)	Code
Cable clip 4	4	1x1 - 2x0,5	2x20	100	13620004
Cable clip 5	5	2x0,75	2x22	100	13620005
Cable clip 6	6	2x1,0	2x22	100	13620006
Cable clip 7	7	2x1 - 2x1,5	2x27	100	13620007
Cable clip 8	8	2x2,5	2x27	100	13620008
Cable clip 9	9	3x2,5	2x27	100	13620009
Cable clip 10	10	2x4,0	2x30	100	13620010

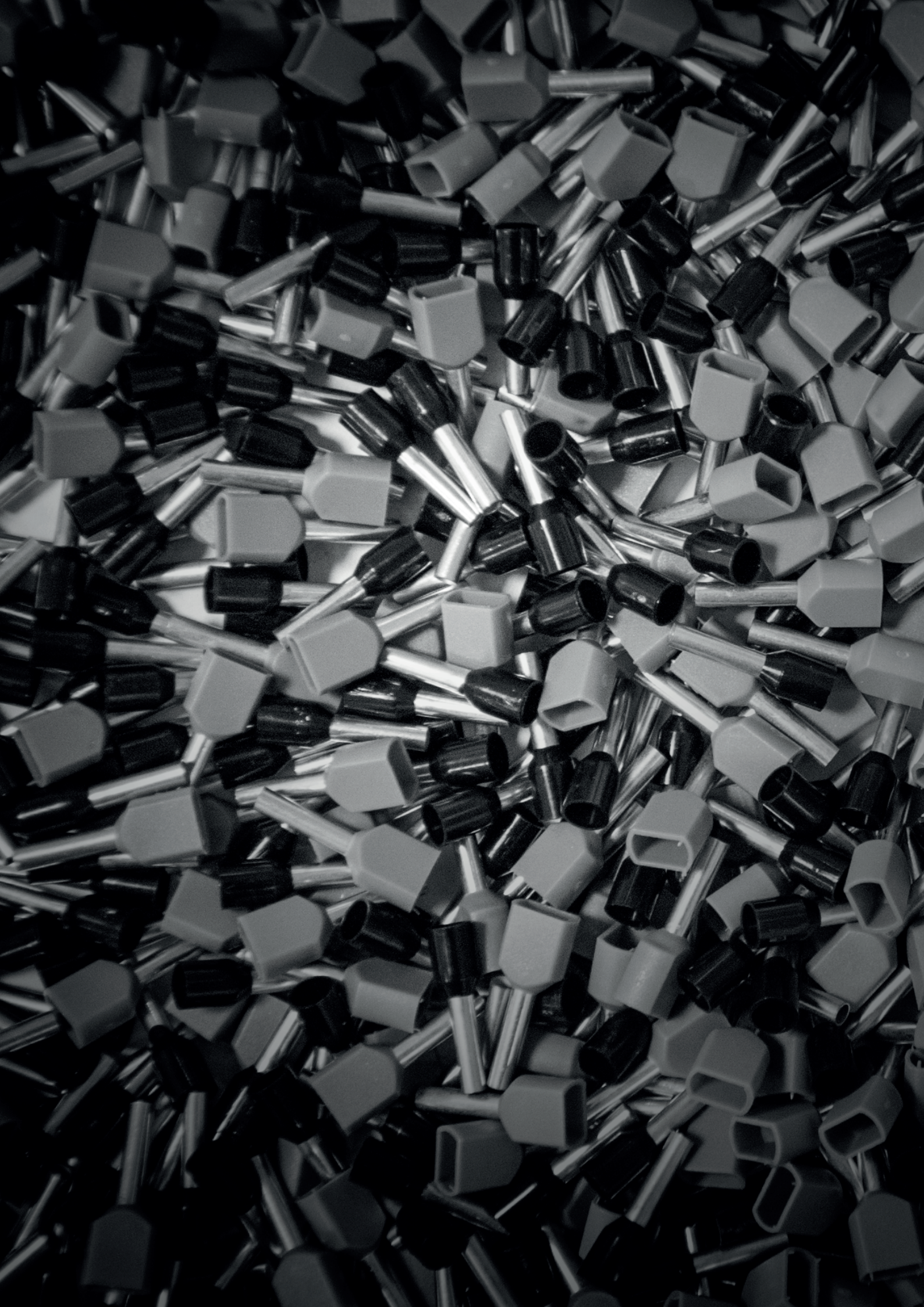



CABLING AND CONNECTION

TERMINAL BLOCKS

E-bloks Single Pole Terminal Blocks	46
Multi-Way Terminal Blocks	48

END-SLEEVES

Non-insulated End-Sleeves	49
Insulated End-Sleeves for Single Cable	50
Insulated End-Sleeves for Two Cables	52
Assortment of Insulated End-Sleeves	53

INSULATED TERMINAL LUGS

Insulated terminal lugs	54
--------------------------------	----

COPPER LUGS

Joint Connectors - Heat Shrinking Insulation	58
Non-insulated Tubular Cable lugs	59

E-bloks Single Pole Terminal Blocks

Single pole terminal blocks, 1 or 2 inputs, in transparent Polycarbonate, with screw clamping, for free connections

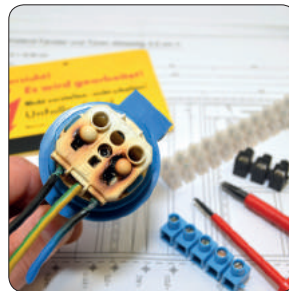
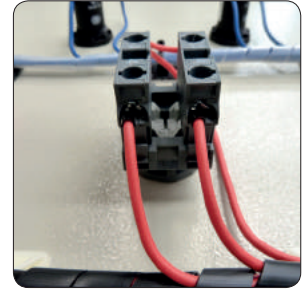

Features and benefits

- Single pole terminal blocks can be easily split up from the 10 or 5 pins bars
- Fast and safe connection and tightening thanks to the increased dimensions of the insulating body of the terminal and of the screws

Technical data

Insulation material	transparent polycarbonate, polyamide interiors and bases
Material of insert	brass
Screw material	zinc-plated steel
Halogen	absent
Working temperature	-5°C ÷ 85°C
Heat resistance	130°C
Flame retention	UL94 class V2

Applications

- Industrial and domestic electrical wiring

Approvals and certifications

EN 60998-1:2004

EN 60998-2-1:2004

EN 60998-2-2:2004



HALOGEN FREE

E-BLOKS ONE INPUT SINGLE POLE TERMINAL BLOCK

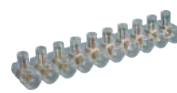
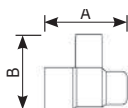

10 POLES



5 POLES



1 POLE

Description	Section (mm ²)	N° poles	Cable section (mm ²)	Nominal tension (V)	Degree of protection	Width (mm)	Height (mm)	Pack (pcs.)	Code
						A	B		
Single pole terminal block 1,5x10	1,5	10	1÷1,5	450	IP20	16	15	25	EBS 15
Single pole terminal block 2,5x10	2,5	10	1,5÷2,5	450	IP20	20	18	25	EBS 25
Single pole terminal block 4x10	4	10	2,5÷4	450	IP20	22	20	25	EBS 40
Single pole terminal block 6x10	6	10	4÷6	450	IP20	25	22	25	EBS 60
Single pole terminal block 10x10	10	10	6÷10	500	IP20	29	26	10	EBS 100
Single pole terminal block 16x5	16	5	6÷16	500	IP00	35	31	10	EBS 160
Single pole terminal block 25x1	25	1	10÷25	500	IP00	39	40	5	EBS 250
Single pole terminal block 35x1	35	1	16÷35	500	IP00	46	43	5	EBS 350

Multi-Way Terminal Blocks

Multi-way terminal blocks for junctions between conductors, with screw clamping, for operating temperatures up to 85 ° C (Polyethylene Insulation) and up to 110 ° C (Polyamide Insulation)

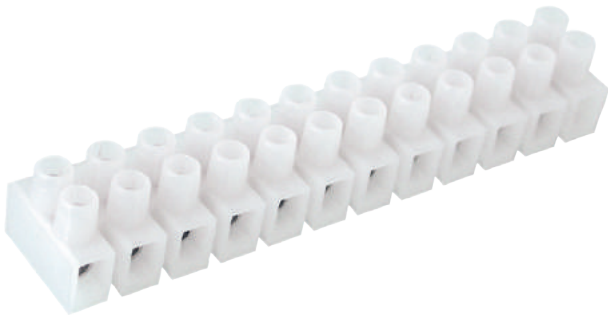

Technical data

Insulation material	clear polyethylene neutral polyamide
Material of insert	brass (PE version) nickel brass (PA version)
Screw material	zinc-plated steel
Halogen	absent
Working temperature	-5°C + 85°C (PE version) -30°C ÷ 110°C (PA version) max 150°C for short period (PA version)
Flame retention	UL94 class V2 (PA version)

Applications

- Junctions or shunts of conductors in industrial and domestic electrical wiring.

Approvals and certifications

EN 60998-2-1: 2004 (PE line - PA line)

EN 60998-1 + A1: 2001 (PA line)

HALOGEN FREE

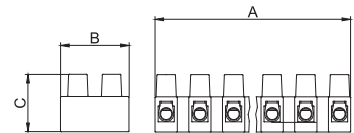

MULTI-WAY TERMINAL BLOCK IN NEUTRAL POLYETHYLENE

Description	Section (mm ²)	N° poles	Nominal tension (V)	Degree of protection	Length (mm)	Width (mm)	Height (mm)	Pack (pcs.)	Code
Multi-way terminal block PE 2,5	2,5	12	450	IP20	93	16,5	12	10	EMPP 25
Multi-way terminal block PE 4	4	12	450	IP20	116	19	16,5	10	EMPP 40
Multi-way terminal block PE 6	6	12	450	IP20	130	21	17	10	EMPP 60
Multi-way terminal block PE 10	10	12	450	IP20	165	26	20	10	EMPP 100
Multi-way terminal block PE 16	16	12	450	IP20	185	31	26	10	EMPP 160

MULTI-WAY TERMINAL BLOCK IN NEUTRAL POLYAMIDE

Description	Section (mm ²)	N° poles	Nominal tension (V)	Degree of protection	Length (mm)	Width (mm)	Height (mm)	Pack (pcs.)	Code
Multi-way terminal block PA 1,5	1,5	12	450	IP20	94	16,5	15	10	EMPA 15
Multi-way terminal block PA 2,5	2,5	12	450	IP20	116	18	16	10	EMPA 25
Multi-way terminal block PA 4	4	12	450	IP20	140	23	19	10	EMPA 40
Multi-way terminal block PA 10	10	12	450	IP00	172	32	25	10	EMPA 100
Multi-way terminal block PA 16	16	12	450	IP00	209	37	34	10	EMPA 160

Non-insulated End-sleeves

Non-insulated end-sleeves for copper conductors ends

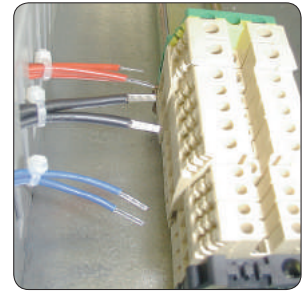
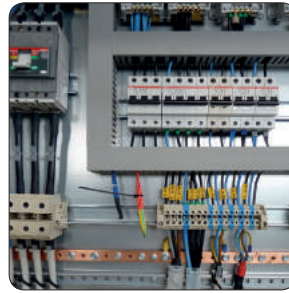

Features and benefits

- Protecting and compacting ends of copper conductors, to facilitate the inserting in the terminal blocks

Technical data

Conductor material electrolytic tinned copper (purity grade 99.9%)

Applications

- Cabling and connections in electrical and electronic switchgears

Approvals and certifications

Compliant with DIN 46228/1

HALOGEN FREE



NON-INSULATED END-SLEEVES

Description	Section (mm ²)	Section (AWG)	Length (mm)	ø hole (mm)		Pack (pcs.)	Code
				A	B		
End-sleeve 1x6	1	17	6	1,4		500	11001031
End-sleeve 1x10	1	17	10	1,4		500	11001032
End-sleeve 1,5x7	1,5	16	7	1,7		500	11001041
End-sleeve 1,5x10	1,5	16	10	1,7		500	11001042
End-sleeve 2,5x7	2,5	14	7	2,2		500	11001051
End-sleeve 2,5x10	2,5	14	10	2,2		500	11001052
End-sleeve 4x9	4	12	9	2,8		500	11001061
End-sleeve 4x12	4	12	12	2,8		500	11001062
End-sleeve 6x12	6	10	12	3,5		100	11001071
End-sleeve 6x15	6	10	15	3,5		100	11001072
End-sleeve 10x12	10	7	12	4,5		100	11001081
End-sleeve 10x15	10	7	15	4,5		100	11001082
End-sleeve 16x15	16	6	15	5,8		100	11001092
End-sleeve 16x18	16	6	18	5,8		100	11001093
End-sleeve 25x15	25	3	15	7,3		50	11001101
End-sleeve 35x18	35	2	18	8,3		50	11001111
End-sleeve 50x25	50	1	25	10,3		50	11001122

Hand tools for terminals
from page 192

Insulated End-sleeves for Single Cable

Polypropylene Insulated end-sleeve for single copper conductors end

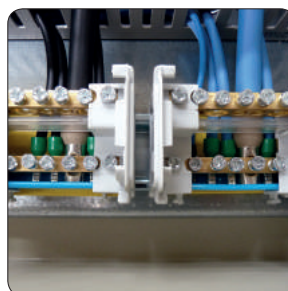
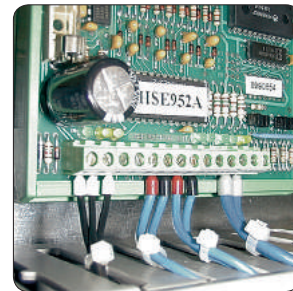

Features and benefits

- Excellent electrical conductivity (tinned copper, 99.9%)
- Availability of three colour ranges (T-W-D)
- Available in 50-piece strips (0.5 ÷ 2.5 mm²)

Technical data

Conductor material	electrolytic tinned copper (purity grade 99.9%)
Insulation material	PVC for joints and grafts. Self-extinguishing UL94 class V2
Halogen	absent
Working temperature	-10°C + 105°C
Installation temperature	0°C + 60°C
Maximum allowable temperature	120°C for short period
Resistance to external agents	
Good resistance to bases and weak acids. Limited resistance to strong oxidant acids, oils and minerals. No resistance to chloride solvents.	

Applications

- Cabling and connections in electrical and electronic switchgears

Approvals and certifications

Compliant, by color and size, with DIN 46228/4
CSA Certification No. 250148



HALOGEN FREE

INSULATED END-SLEEVES FOR SINGLE CABLE CUTTING STRIP

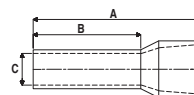

Description	Section (mm ²)	Section (AVG)	Length (mm)	Pin length (mm)		Ø pin (mm)	Color	Type of color	Pack (pcs.)	Code
				A	B					
Insulated end-sleeves for single cable 0,50/N bianco - T cutting strip	0,5	20	14	8	1	○	T	500	E02B	
Insulated end-sleeves for single cable 0,75/N blu - T cutting strip	0,75	18	14	8	1,2	●	T	500	E05B	
Insulated end-sleeves for single cable 1,00/N rosso - T cutting strip	1	18	14	8	1,4	●	T	500	E09B	
Insulated end-sleeves for single cable 1,5/N nero - T cutting strip	1,5	16	14	8	1,7	●	T	500	E13B	
Insulated end-sleeves for single cable 2,5/N grigio - T cutting strip	2,5	14	14	8	2,2	●	T	500	E16B	

Punctual length: N = normal - Color type: T = telemecanique
D = Din - W = Weidmuller

Hand tools for terminals
from page 192

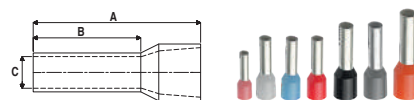

INSULATED END-SLEEVES

Description	Section (mm ²)	Section (AVG)	Length (mm)		Ø pin (mm)	Color	Type of color	Pack (pcs.)	Code
			A	B					
Insulated end-sleeves 0,25/N violet - T	0,25	24	10	6	0,75	●	T	500	E034
Insulated end-sleeves 0,25/N light bluee - W	0,25	24	10	6	0,75	●	W	500	E134
Insulated end-sleeves 0,34/N pink - T	0,34	22	10	6	0,8	●	T	500	E036
Insulated end-sleeves 0,34/N sea green - W	0,34	22	10	6	0,8	●	W	500	E136
Insulated end-sleeves 0,50/K white - T/D	0,5	20	12	6	1	○	T/D	500	E01
Insulated end-sleeves 0,50/N white - T/D	0,5	20	14	8	1	○	T/D	500	E02
Insulated end-sleeves 0,50/N white - T	0,5	20	14	8	1	○	T	100	E02C
Insulated end-sleeves 0,5/K orange - W	0,5	20	12	6	1	●	W	500	E010
Insulated end-sleeves 0,50/N orange - W	0,5	20	14	8	1	●	W	500	E020
Insulated end-sleeves 0,75/K light blue - T	0,75	18	12	6	1,2	●	T	500	E04
Insulated end-sleeves 0,75/N light blue - T	0,75	18	14	8	1,2	●	T	500	E05
Insulated end-sleeves 0,75/N light blue - T	0,75	18	14	8	1,2	●	T	100	E05C
Insulated end-sleeves 0,75/HL light blue - T	0,75	18	16	10	1,2	●	T	500	E06
Insulated end-sleeves 0,75/K white - W	0,75	18	12	6	1,2	○	W	500	E040
Insulated end-sleeves 0,75/N white - W	0,75	18	14	8	1,2	○	W	500	E050
Insulated end-sleeves 0,75/HL white - W	0,75	18	16	10	1,2	○	W	500	E060
Insulated end-sleeves 0,75/K grey - D	0,75	18	12	6	1,2	●	D	500	E004D
Insulated end-sleeves 0,75/N grey - D	0,75	18	14	8	1,2	●	D	500	E005D
Insulated end-sleeves 0,75/HL grey - D	0,75	18	16	10	1,2	●	D	500	E006D
Insulated end-sleeves 1,00/K red - T/D	1	18	12	6	1,4	●	T/D	500	E08
Insulated end-sleeves 1,00/N red - T/D	1	18	14	8	1,4	●	T/D	500	E09
Insulated end-sleeves 1,00/N red - T	1	18	14	8	1,4	●	T	100	E09C
Insulated end-sleeves 1,00/HL red - T/D	1	18	16	10	1,4	●	T/D	500	E10
Insulated end-sleeves 1,00/K yellow - W	1	18	12	6	1,4	●	W	500	E080
Insulated end-sleeves 1,00/N yellow - W	1	18	14	8	1,4	●	W	500	E090
Insulated end-sleeves 1,00/HL yellow - W	1	18	16	10	1,4	●	W	500	E100
Insulated end-sleeves 1,50/N black - T/D	1,5	16	14	8	1,7	●	T/D	500	E13
Insulated end-sleeves 1,50/N black - T	1,5	16	14	8	1,7	●	T	100	E13C
Insulated end-sleeves 1,50/HL black - T/D	1,5	16	16	10	1,7	●	T/D	500	E14
Insulated end-sleeves 1,50/N red - W	1,5	16	14	8	1,7	●	W	500	E113
Insulated end-sleeves 1,50/HL red - W	1,5	16	16	10	1,7	●	W	500	E114
Insulated end-sleeves 2,50/N grey - T	2,5	14	14	8	2,2	●	T	500	E16
Insulated end-sleeves 2,50/N grey - T	2,5	14	14	8	2,2	●	T	100	E16C
Insulated end-sleeves 2,50/HL grey - T	2,5	14	18	12	2,2	●	T	500	E17
Insulated end-sleeves 2,50/N blue - W/D	2,5	14	14	8	2,2	●	W/D	500	E116
Insulated end-sleeves 2,50/HL blue - W/D	2,5	14	18	12	2,2	●	W/D	500	E117
Insulated end-sleeves 4,00/N orange - T	4	12	16,5	10	2,8	●	T	500	E19
Insulated end-sleeves 4,00/N orange - T	4	12	16,5	10	2,8	●	T	100	E19C
Insulated end-sleeves 4,00/HL orange - T	4	12	19,5	12	2,8	●	T	500	E20
Insulated end-sleeves 4,00/N grey - W/D	4	12	16,5	10	2,8	●	W/D	500	E119
Insulated end-sleeves 4,00/HL grey - W/D	4	12	19,5	12	2,8	●	W/D	500	E120
Insulated end-sleeves 6,00/N verde - T	6	10	20	12	3,5	●	T	100	E22
Insulated end-sleeves 6,00/N black - W	6	10	20	12	3,5	●	W	100	E122
Insulated end-sleeves 6,00/N yellow - D	6	10	20	12	3,5	●	D	100	E022D
Insulated end-sleeves 10,00/N brown - T	10	8	22	12	4,5	●	T	100	E24
Insulated end-sleeves 10,00/N panna - W	10	8	22	12	4,5	●	W	100	E124
Insulated end-sleeves 10,00/N red - D	10	8	22	12	4,5	●	D	100	E024D
Insulated end-sleeves 16,00/N cream - T	16	6	24	12	5,8	●	T	100	E26
Insulated end-sleeves 16,00/N green - W	16	6	24	12	5,8	●	W	100	E126
Insulated end-sleeves 16,00/N blue - D	16	6	24	12	5,8	●	D	100	E026D
Insulated end-sleeves 25,00/N black - T	25	4	30	16	7,3	●	T	50	E28
Insulated end-sleeves 25,00/N brown - W	25	4	30	16	7,3	●	W	50	E128
Insulated end-sleeves 25,00/N yellow - D	25	4	30	16	7,3	●	D	50	E028D
Insulated end-sleeves 35,00/N red - T/D	35	2	30	16	8,3	●	T/D	50	E30
Insulated end-sleeves 35,00/N grey - W	35	2	30	16	8,3	●	W	50	E130
Insulated end-sleeves 50,00/N blue - T/D	50	1	36	20	10,3	●	T/D	50	E32
Insulated end-sleeves 50,00/N dark green - W	50	1	36	20	10,3	●	W	50	E132

Punctual length: N = normal - Color type: T = telemecanique
D = Din - W = Weidmuller

Insulated End-Sleeves for Two Cables

Polypropylene insulated end-sleeves for two copper conductors ends

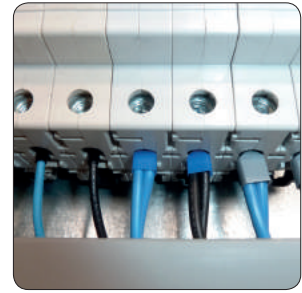
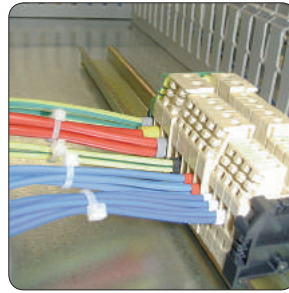

Features and benefits

- Excellent electrical conductivity (tinned copper, 99.9%)
- Available in two color ranges (T-D)
- Allows the inserting of two connectors in the same input of the terminal block

Technical data

Conductor material	electrolytic tinned copper (purity grade 99.9%)
Insulation material	polypropylene self-extinguishing UL94 class V2
Halogen	absent
Working temperature	-10°C + 105°C
Installation temperature	0°C + 60°C
Maximum allowable temperature	120°C for short period
Resistance to external agents	
Good resistance to bases and weak acids. Limited resistance to strong oxidant acids, oils and minerals. No resistance to chloride solvents.	

Applications

- Cabling and connections in electrical and electronic switchgears

Approvals and certifications

Compliant, by color and size, with DIN 46228/4
 CSA Certification No. 250148



HALOGEN FREE

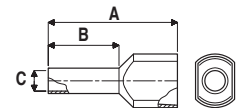

INSULATED END-SLEEVES FOR TWO CABLES

Description	Section (mm²)	Length (mm)			Color	Type of color	Pack (pcs.)	Code
		A	B	C				
Insulated end-sleeves for two cables 2x0,50/N white - T/D	2x0,50	15	8	1,4	●	T/D	500	11031002
Insulated end-sleeves for two cables 2x0,75/N blue - T	2x0,75	15	8	1,7	●	T	500	11031005 T
Insulated end-sleeves for two cables 2x0,75/N grey - D	2x0,75	15	8	1,7	●	D	500	11031005
Insulated end-sleeves for two cables 2x1,00/N red - T/D	2x1,00	15	8	1,95	●	T/D	500	11031009
Insulated end-sleeves for two cables 2x1,50/N black - T/D	2x1,5	16	8	2,2	●	T/D	500	11031013
Insulated end-sleeves for two cables 2x2,50/N grey - T	2x2,5	18,5	10	2,8	●	T	250	11031016 T
Insulated end-sleeves for two cables 2x2,50/N blue - D	2x2,5	18,5	10	2,8	●	D	250	11031016
Insulated end-sleeves for two cables 2x4,00/N orange - T	2x4,0	23	12	3,7	●	T	100	11031019 T
Insulated end-sleeves for two cables 2x4,00/N grey - D	2x4,00	23	12	3,7	●	D	100	11031019
Insulated end-sleeves for two cables 2x6,00/N dark green - T	2x6,00	26	14	4,8	●	T	100	11031022 T
Insulated end-sleeves for two cables 2x6,00/N yellow - D	2x6,00	26	14	4,8	●	D	100	11031022
Insulated end-sleeves for two cables 2x10,00/N brown	2x10,00	26	14	6,4	●	T	100	11031024 T
Insulated end-sleeves for two cables 2x10,00/N red - D	2x10,00	26	14	6,4	●	D	100	11031024
Insulated end-sleeves for two cables 2x16,00/N cream - T	2x16,00	30	14	8,2	●	T	50	11031026 T
Insulated end-sleeves for two cables 2x16,00/N blue - D	2x16,00	30	14	8,2	●	D	50	11031026

Punctual length: N = normal - Color type: T = telemecanique
 D = Din - W = Weidmuller

Hand tools for terminals
 from page 192

Assortment of Insulated End-Sleeves

Assortment in dispenser box of insulated end-sleeves, in different sizes and colors



Features and benefits

- The assortment of various sections and colors makes it possible to find the most suitable terminal for installation needs
- The transparent dispenser box is divided into separate sectors in order to facilitate the choice of the terminal
- Box dimensions: diameter = 90 mm; h = 45 mm

Applications

- Cabling and connections in electrical and electronic switchgears

Approvals and certifications

Compliant, by color and size, with DIN 46228/4
CSA Certification No. 250148



HALOGEN FREE

INSULATED END-SLEEVES ASSORTMENT BOX FROM 0,50 TO 2,5 MM²

Color (T)	Section (mm ²)	Pack (pcs.)	Code
Preinsulated copper end-sleeves from 0,50 a 2,5 mm ²			
		400	11012001
Assortibox			
●	0,5	50	-
●	0,75	100	-
●	1	100	-
●	1,5	100	-
●	2,5	50	-

Color type: T = telemecanique

INSULATED END-SLEEVES ASSORTMENT BOX FROM 4 TO 16 MM²

Color (T)	Section (mm ²)	Pack (pcs.)	Code
Preinsulated copper end-sleeves from da 4 a 16 mm ²			
		100	11012002
Assortibox			
●	4	50	-
●	6	20	-
●	10	20	-
●	16	10	-

Color type: T = telemecanique

Hand tools for terminals
from page 192

Insulated Terminal Lugs

Insulated terminal lugs in electrolytic tinned copper, available with Nylon and PVC insulation

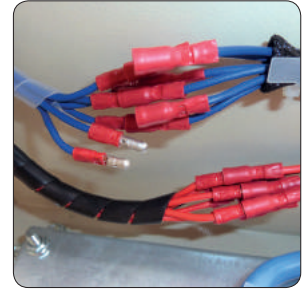
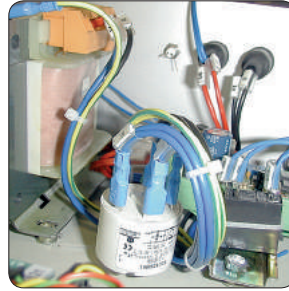

Features and benefits

- Electrolytic copper (at 99.9%) annealed and electrolytically tinned to facilitate cable crimping
- The Nylon insulated terminals are equipped with "Easy Entry" barrel to make the insertion of the conductors quicker and easier
- The PVC Insulated terminals are equipped with special barrel with anti-vibration end-sleeve to avoid tearing and unthreading of the cable even in conditions of high mechanical stress

Technical data

Conductor material	electrolytic tinned copper (purity grade 99.9%) obtained from annealed and electrolytically tinned copper sheets
Insulation material	Nylon (Easy Entry system) for rings, forks, pins and connectors PVC for joints and grafts. Self-extinguishing UL94 class V2
Working temperature	Nylon up to 105°C PVC up to 75°C

Applications

- Connection of cables on terminal blocks (ring, fork and pin type)
- Connection and insulation of electric cables (caps and terminals)
- Leads, junctions and cable insulation (quick connectors)
- Connection of cables (joints and couplings)

Approvals and certifications

Compliant with DIN 46237 (eyelets, forks, tips) UL Certification - E344191 / E344188



HALOGEN FREE

only with insulating Nylon

Hand tools for terminals
from page 192

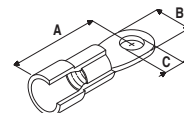

NYLON RING TERMINAL

Description	Cable section (mm ²)	Cable section (AWG)	Length (mm)	Width (mm)	ø Ring terminal (mm)	Color	Pack (pcs.)	Code
			A	B	C			
Nylon ring terminal 0,25÷1,5	0,25 ÷ 1,5	22 ÷ 16	19,7	6	3,2	●	100	11201134
Nylon ring terminal 0,25÷1,5	0,25 ÷ 1,5	22 ÷ 16	19,7	6	3,7	●	100	11201135
Nylon ring terminal 0,25÷1,5	0,25 ÷ 1,5	22 ÷ 16	21,7	8	4,3	●	100	11201143
Nylon ring terminal 0,25÷1,5	0,25 ÷ 1,5	22 ÷ 16	23,7	10	5,3	●	100	11201150
Nylon ring terminal 0,25÷1,5	0,25 ÷ 1,5	22 ÷ 16	24,3	11	6,0	●	100	11201161
Nylon ring terminal 0,25÷1,5	0,25 ÷ 1,5	22 ÷ 16	29,7	14	8,4	●	100	11201180
Nylon ring terminal 0,25÷1,5	0,25 ÷ 1,5	22 ÷ 16	33,7	18	10,5	●	100	11201191
Nylon ring terminal 1,5÷2,5	1,5 ÷ 2,5	16 ÷ 14	19,7	6	3,2	●	100	11201232
Nylon ring terminal 1,5÷2,5	1,5 ÷ 2,5	16 ÷ 14	19,7	6	3,7	●	100	11201236
Nylon ring terminal 1,5÷2,5	1,5 ÷ 2,5	16 ÷ 14	21,7	8	4,3	●	100	11201239
Nylon ring terminal 1,5÷2,5	1,5 ÷ 2,5	16 ÷ 14	24,7	10	5,3	●	100	11201250
Nylon ring terminal 1,5÷2,5	1,5 ÷ 2,5	16 ÷ 14	27,2	11	6,0	●	100	11201261
Nylon ring terminal 1,5÷2,5	1,5 ÷ 2,5	16 ÷ 14	29,7	14	8,4	●	100	11201280
Nylon ring terminal 1,5÷2,5	1,5 ÷ 2,5	16 ÷ 14	33,2	18	10,5	●	100	11201291
Nylon ring terminal 1,5÷2,5	1,5 ÷ 2,5	16 ÷ 14	34,7	18	13,0	●	100	11201295
Nylon ring terminal 4÷6	4 ÷ 6	12 ÷ 10	25	8	4,3	●	100	11201440
Nylon ring terminal 4÷6	4 ÷ 6	12 ÷ 10	26,7	10	5,3	●	100	11201450
Nylon ring terminal 4÷6	4 ÷ 6	12 ÷ 10	27,7	11	6,0	●	100	11201460
Nylon ring terminal 4÷6	4 ÷ 6	12 ÷ 10	32,7	14	8,4	●	100	11201480
Nylon ring terminal 4÷6	4 ÷ 6	12 ÷ 10	36,7	18	10,5	●	100	11201491
Nylon ring terminal 4÷6	4 ÷ 6	12 ÷ 10	36,7	18	13,0	●	100	11201495

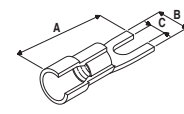

NYLON FORK TERMINAL

Description	Cable section (mm ²)	Cable section (AWG)	Length (mm)	Width (mm)	ø fork (mm)	Color	Pack (pcs.)	Code
			A	B	C			
Nylon fork terminal 0,25÷1,5	0,25 ÷ 1,5	22 ÷ 16	19,3	6	3,2	●	100	11202132
Nylon fork terminal 0,25÷1,5	0,25 ÷ 1,5	22 ÷ 16	19,3	6	3,7	●	100	11202135
Nylon fork terminal 0,25÷1,5	0,25 ÷ 1,5	22 ÷ 16	21,3	8	4,3	●	100	11202140
Nylon fork terminal 0,25÷1,5	0,25 ÷ 1,5	22 ÷ 16	23,3	10	5,3	●	100	11202150
Nylon fork terminal 0,25÷1,5	0,25 ÷ 1,5	22 ÷ 16	25,9	11	6,5	●	100	11202160
Nylon fork terminal 1,5÷2,5	1,5 ÷ 2,5	16 ÷ 14	19,6	6	3,2	●	100	11202232
Nylon fork terminal 1,5÷2,5	1,5 ÷ 2,5	16 ÷ 14	19,6	6	3,7	●	100	11202240
Nylon fork terminal 1,5÷2,5	1,5 ÷ 2,5	16 ÷ 14	21,6	8	4,3	●	100	11202242
Nylon fork terminal 1,5÷2,5	1,5 ÷ 2,5	16 ÷ 14	24,6	10	5,3	●	100	11202250
Nylon fork terminal 1,5÷2,5	1,5 ÷ 2,5	16 ÷ 14	27,1	11	6,5	●	100	11202261
Nylon fork terminal 4÷6	4 ÷ 6	12 ÷ 10	23,9	8	4,3	●	100	11202440
Nylon fork terminal 4÷6	4 ÷ 6	12 ÷ 10	26,1	10	5,3	●	100	11202450
Nylon fork terminal 4÷6	4 ÷ 6	12 ÷ 10	27,9	11	4,0	●	100	11202460
Nylon fork terminal 4÷6	4 ÷ 6	12 ÷ 10	32,3	14	8,4	●	100	11202480
Nylon fork terminal 4÷6	4 ÷ 6	12 ÷ 10	35,4	18	10,5	●	100	11202490

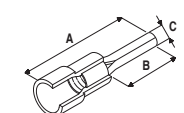

NYLON PIN TERMINAL

Description	Cable section (mm ²)	Cable section (AWG)	Length (mm)	Pin length (mm)	ø pin (mm)	Color	Pack (pcs.)	Code
			A	B	C			
Nylon pin terminal 0,25÷1,5	0,25 ÷ 1,5	22 ÷ 16	21,5	10	1,9	●	100	11210112
Nylon pin terminal 0,25÷1,5	0,25 ÷ 1,5	22 ÷ 16	23,5	12	1,9	●	100	11210115
Nylon pin terminal 1,5÷2,5	1,5 ÷ 2,5	16 ÷ 14	20,5	10	1,9	●	100	11210212
Nylon pin terminal 1,5÷2,5	1,5 ÷ 2,5	16 ÷ 14	23,5	12	1,9	●	100	11210215
Nylon pin terminal 4÷6	4 ÷ 6	12 ÷ 10	23,5	14	2,9	●	100	11210412

INSULATED NYLON END CONNECTORS

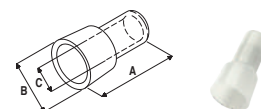

Description	Cable section (mm ²)	Cable section (AWG)	Length (mm)	Width (mm)	ø seat (mm)	Pack (pcs.)	Code
			A	B	C		
Insulated nylon end connector 0,25÷1,4	0,25 ÷ 1,5	22 ÷ 16	18,1	7,8	2,6	100	ECDCE-1
Insulated nylon end connector 1,5÷2,4	1,5 ÷ 2,5	16 ÷ 14	20,1	9,3	3,3	100	ECDCE-2
Insulated nylon end connector 4÷5	4 ÷ 6	12 ÷ 10	25,5	11,8	4,5	100	ECDCE-5

POLYPROPYLENE RAPID CONNECTORS FOR SWITCHES, JOINTS AND TERMINATIONS

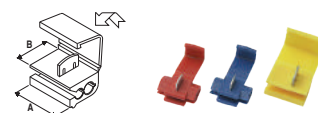

Description	Cable section (mm ²)	Cable section (AWG)	Length (mm)	Width (mm)	Color	Pack (pcs.)	Code
			A	B			
Polypropylene nylon connector 0,25÷1,5	0,25 ÷ 1,5	22 ÷ 16	20	13,4	●	100	ESCR
Polypropylene nylon connector 1,5÷2,5	1,5 ÷ 2,5	16 ÷ 14	20	13,4	●	100	ESCB
Polypropylene nylon connector 4÷6	4 ÷ 6	12 ÷ 10	20	17,5	●	100	ESCG

PVC BUTT CONNECTORS



Description	Cable section (mm ²)	Cable section (AWG)	Length (mm)	ø seat (mm)	Color	Pack (pcs.)	Code
			A	B			
PVC butt connector 0,25÷1,5	0,25 ÷ 1,5	22 ÷ 16	26	4,3	●	100	11220140
PVC butt connector 1,5÷2,5	1,5 ÷ 2,5	16 ÷ 14	26	4,8	●	100	11220250
PVC butt connector 4÷6	4 ÷ 6	12 ÷ 10	27	6,7	●	100	11220465

PVC FEMALE PUSH-ON TERMINALS WITH COPPER BUSH



Description	Cable section (mm ²)	Cable section (AWG)	Length (mm)	Tab width (mm)	Tab thickness (mm)	Color	Pack (pcs.)	Code
			A	B	C			
PVC female push-on terminal 0,25÷1,5	0,25 ÷ 1,5	22 ÷ 16	19	3,2	0,5	●	100	11231128
PVC female push-on terminal 0,25÷1,5	0,25 ÷ 1,5	22 ÷ 16	19	3,2	0,8	●	100	11231129
PVC female push-on terminal 0,25÷1,5	0,25 ÷ 1,5	22 ÷ 16	19,4	5	0,5	●	100	11231150
PVC female push-on terminal 0,25÷1,5	0,25 ÷ 1,5	22 ÷ 16	19,4	5	0,8	●	100	11231149
PVC female push-on terminal 0,25÷1,5	0,25 ÷ 1,5	22 ÷ 16	20,8	6,6	0,8	●	100	11231163
PVC female push-on terminal 1,5÷2,5	1,5 ÷ 2,5	16 ÷ 14	19	3,2	0,5	●	100	11231228
PVC female push-on terminal 1,5÷2,5	1,5 ÷ 2,5	16 ÷ 14	19,4	5	0,5	●	100	11231250
PVC female push-on terminal 1,5÷2,5	1,5 ÷ 2,5	16 ÷ 14	19,4	5	0,8	●	100	11231249
PVC female push-on terminal 1,5÷2,5	1,5 ÷ 2,5	16 ÷ 14	20,8	6,7	0,8	●	100	11231263
PVC female push-on terminal 4÷6	4 ÷ 6	12 ÷ 10	23,3	6,7	0,8	●	100	11231463

PVC MALE PUSH-ON TERMINALS WITH COPPER BUSH



Description	Cable section (mm ²)	Cable section (AWG)	Length (mm)	Tab width (mm)	Tab thickness (mm)	Color	Pack (pcs.)	Code
			A	B	C			
PVC male push-on terminal 0,25÷1,5	0,25 ÷ 1,5	22 ÷ 16	19,2	2,8	0,5	●	100	11230128
PVC male push-on terminal 0,25÷1,5	0,25 ÷ 1,5	22 ÷ 16	19,8	4,8	0,8	●	100	11230153
PVC male push-on terminal 0,25÷1,5	0,25 ÷ 1,5	22 ÷ 16	21,8	6,3	0,8	●	100	11230163
PVC male push-on terminal 1,5÷2,5	1,5 ÷ 2,5	16 ÷ 14	19,8	4,8	0,8	●	100	11230253
PVC male push-on terminal 1,5÷2,5	1,5 ÷ 2,5	16 ÷ 14	21,8	6,3	0,8	●	100	11230263
PVC male push-on terminal 4÷6	4 ÷ 6	12 ÷ 10	24	6,3	0,8	●	100	11230463

PVC PIGGY BACK WITH COPPER BUSH

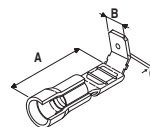

Description	Cable section (mm ²)	Cable section (AWG)	Length (mm)	Tab width (mm)	Tab thickness (mm)	Color	Pack (pcs.)	Code
			A	B	C			
PVC piggy back 0,25÷1,5	0,25 ÷ 1,5	22 ÷ 16	22,5	6,3	0,8	●	100	11232153
PVC piggy back 1,5÷2,5	1,5 ÷ 2,5	16 ÷ 14	22,5	6,3	0,8	●	100	11232263
PVC piggy back 4÷6	4 ÷ 6	12 ÷ 10	24	6,3	0,8	●	100	11232463

PVC FULLY INSULATED FEMALE PUSH-ON TERMINALS WITH COPPER BUSH

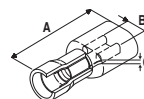

Description	Cable section (mm ²)	Cable section (AWG)	Length (mm)	Tab width (mm)	Tab thickness (mm)	Color	Pack (pcs.)	Code
			A	B	C			
PVC fully insulated female push-on terminal 0,25÷1,5	0,25 ÷ 1,5	22 ÷ 16	19	3,2	0,5	●	100	11235125
PVC fully insulated female push-on terminal 0,25÷1,5	0,25 ÷ 1,5	22 ÷ 16	19	3,2	0,8	●	100	11235128
PVC fully insulated female push-on terminal 0,25÷1,5	0,25 ÷ 1,5	22 ÷ 16	20,5	5	0,5	●	100	11235148
PVC fully insulated female push-on terminal 0,25÷1,5	0,25 ÷ 1,5	22 ÷ 16	20,5	5	0,8	●	100	11235153
PVC fully insulated female push-on terminal 0,25÷1,5	0,25 ÷ 1,5	22 ÷ 16	23,5	6,6	0,8	●	100	11235163
PVC fully insulated female push-on terminal 1,5÷2,5	1,5 ÷ 2,5	16 ÷ 14	20,2	5	0,5	●	100	11235248
PVC fully insulated female push-on terminal 1,5÷2,5	1,5 ÷ 2,5	16 ÷ 14	20,2	5	0,8	●	100	11235253
PVC fully insulated female push-on terminal 1,5÷2,5	1,5 ÷ 2,5	16 ÷ 14	23,5	6,6	0,8	●	100	11235263
PVC fully insulated female push-on terminal 4÷6	4 ÷ 6	12 ÷ 10	24,2	6,6	0,8	●	100	11235463

NYLON FULLY INSULATED MALE PUSH-ON TERMINALS WITH COPPER BUSH

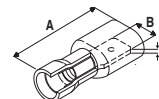

Description	Cable section (mm ²)	Cable section (AWG)	Length (mm)	Tab width (mm)	Tab thickness (mm)	Color	Pack (pcs.)	Code
			A	B	C			
Nylon fully insulated male push-on terminal 0,25÷1,5	0,25 ÷ 1,5	22 ÷ 16	23,4	6,3	0,8	●	100	11236163
Nylon fully insulated male push-on terminal 1,5÷2,5	1,5 ÷ 2,5	16 ÷ 14	23,4	6,3	0,8	●	100	11236263
Nylon fully insulated male push-on terminal 4÷6	4 ÷ 6	12 ÷ 10	27	6,3	0,8	●	100	11236463

PVC MALE BULLET TERMINALS WITH COPPER BUSH

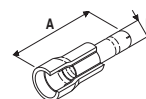

Description	Cable section (mm ²)	Cable section (AWG)	Length (mm)	ø pin (mm)	Color	Pack (pcs.)	Code
			A	B			
PVC male bullet terminal 0,25÷1,5	0,25 ÷ 1,5	22 ÷ 16	21,5	4	●	100	11240148
PVC male bullet terminal 1,5÷2,5	1,5 ÷ 2,5	16 ÷ 14	21,7	4	●	100	11240248
PVC male bullet terminal 4÷6	4 ÷ 6	12 ÷ 10	24	5	●	100	11240448

PVC FEMALE SOCKET TERMINALS WITH COPPER BUSH

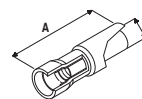

Description	Cable section (mm ²)	Cable section (AWG)	Length (mm)	ø pin (mm)	Color	Pack (pcs.)	Code
			A	B			
PVC female socket terminal 0,25÷1,5	0,25 ÷ 1,5	22 ÷ 16	25	4	●	100	11241148
PVC female socket terminal 1,5÷2,5	1,5 ÷ 2,5	16 ÷ 14	25	4	●	100	11241248
PVC female socket terminal 4÷6	4 ÷ 6	12 ÷ 10	28	5	●	100	11241448

Joint Connectors - Heat Shrinking Insulation

Tinned copper joint with a heat-shrinking Insulation and internal hot-melt adhesive for waterproofing joints



Features and benefits

- Effective sealing and insulation of electrical connections

Applications

- Waterproofing joints in the connection of cables

Technical data

Conductor material	electrolytic tinned copper (purity grade 99.9%)
Insulation material	cross-linked polyolefin
Halogen	absent
Shrinkage temperature	100°C
Working temperature	-55°C + 125°C
Dielectric strength	30 kV/mm

HALOGEN FREE

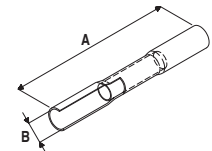

JOINT CONNECTORS - HEAT SHRINKING INSULATION

Description	Cable section (mm ²)	Cable section (AWG)	Length (mm)	ø seat (mm)	Color	Pack (pcs.)	Code
			A	B			
Joint connectors heat shrinking insulation 0,25÷1,5	0,25 ÷ 1,5	22 ÷ 16	36	5,4	●	100	11221140
Joint connectors heat shrinking insulation 1,5÷2,5	1,5 ÷ 2,5	16 ÷ 14	36	5,8	●	100	11221250
Joint connectors heat shrinking insulation 4÷6	4 ÷ 6	12 ÷ 10	41	6	●	100	11221465

Hand tools for terminals
from page 192

Non-insulated Tubular Cable Lugs

Non-insulated tubular cable lugs in tinned copper at high conductivity

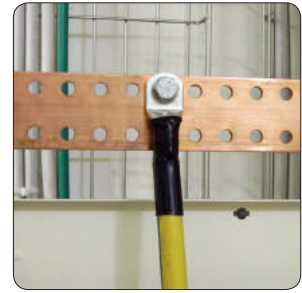
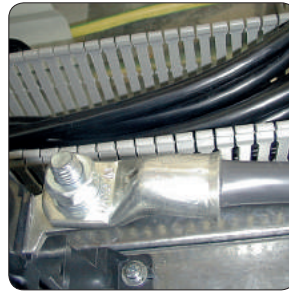

Features and benefits

- Countersunk barrel for easy insertion of the cable
- Tinner surface treatment to protect from oxidising
- Each cable lugs is marked with the cable section and the hole diameter
- The annealing of the material guarantees an optimal and easy crimping

Technical data

Conductor material	electrolytic tinned copper (purity grade 99.9%)
Tinning thickness	4 µm

Applications

- Connection of cables in domestic and industrial switchgears and cabinet
- Head joints with copper electric cables

Approvals and certifications

Compliant with IEC 1238-1: 1993

HALOGEN FREE

Hand tools for terminals
from page 192

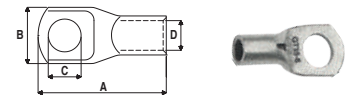

NON-INSULATED TUBULAR CABLE LUGS

Description	Cable section (mm ²)	Length (mm)	Width (mm)	ø hole (mm)	ø seat (mm)	Pack (pcs.)	Code
		A	B	C	D		
Non-insulated tubular cable lugs 1,5 mm ² - Ø6	1,5	21	10	6,4	2,4	100	11301005
Non-insulated tubular cable lugs 2,5 mm ² - Ø4	2,5	19	8,7	4,3	2,7	100	11301008
Non-insulated tubular cable lugs 2,5 mm ² - Ø6	2,5	21	10,3	6,4	2,7	100	11301010
Non-insulated tubular cable lugs 4 mm ² - Ø6	4	23,5	10,3	6,4	3,1	100	11301013
Non-insulated tubular cable lugs 4 mm ² - Ø8	4	28,5	12,5	8,3	3,1	100	11301014
Non-insulated tubular cable lugs 6 mm ² - Ø5	6	26	10,3	5,3	3,8	100	11301016
Non-insulated tubular cable lugs 6 mm ² - Ø6	6	26	10,3	6,4	3,8	100	11301018
Non-insulated tubular cable lugs 6 mm ² - Ø8	6	29	13,9	8,3	3,8	100	11301019
Non-insulated tubular cable lugs 10 mm ² - Ø5	10	27,5	11,9	5,3	4,7	100	11301022
Non-insulated tubular cable lugs 10 mm ² - Ø6	10	27,5	11,9	6,4	4,7	100	11301023
Non-insulated tubular cable lugs 10 mm ² - Ø8	10	30,5	13,5	8,3	4,7	100	11301024
Non-insulated tubular cable lugs 10 mm ² - Ø10	10	30,5	15	10,5	4,7	100	11301025
Non-insulated tubular cable lugs 16 mm ² - Ø5	16	27,5	11,9	5,3	5,6	100	11301028
Non-insulated tubular cable lugs 16 mm ² - Ø6	16	27,5	11,9	6,4	5,6	100	11301029
Non-insulated tubular cable lugs 16 mm ² - Ø8	16	31	13,5	8,3	5,6	100	11301030
Non-insulated tubular cable lugs 16 mm ² - Ø10	16	32	16	10,5	5,6	100	11301031
Non-insulated tubular cable lugs 16 mm ² - Ø12	16	37	17	13,0	5,6	100	11301032
Non-insulated tubular cable lugs 25 mm ² - Ø6	25	34	13,5	6,4	7,1	50	11301036
Non-insulated tubular cable lugs 25 mm ² - Ø8	25	34	13,5	8,3	7,1	50	11301037
Non-insulated tubular cable lugs 25 mm ² - Ø10	25	37	16	10,5	7,1	50	11301038
Non-insulated tubular cable lugs 25 mm ² - Ø12	25	40	18	13,0	7,1	50	11301039
Non-insulated tubular cable lugs 35 mm ² - Ø6	35	39	15,7	6,4	8,2	50	11301041
Non-insulated tubular cable lugs 35 mm ² - Ø8	35	39	15,7	8,3	8,2	50	11301042
Non-insulated tubular cable lugs 35 mm ² - Ø10	35	43	15,7	10,5	8,2	50	11301043
Non-insulated tubular cable lugs 35 mm ² - Ø12	35	43	18	13,0	8,2	50	11301044
Non-insulated tubular cable lugs 50 mm ² - Ø6	50	45	17,9	6,4	9,5	20	11301051
Non-insulated tubular cable lugs 50 mm ² - Ø8	50	45	17,9	8,4	9,5	20	11301052
Non-insulated tubular cable lugs 50 mm ² - Ø10	50	49	17,9	10,5	9,5	20	11301053
Non-insulated tubular cable lugs 50 mm ² - Ø12	50	49	17,9	13,0	9,5	20	11301054
Non-insulated tubular cable lugs 50 mm ² - Ø14	50	54	22	14,5	9,5	20	11301055
Non-insulated tubular cable lugs 70 mm ² - Ø8	70	48	21,5	8,3	11,5	20	11301064
Non-insulated tubular cable lugs 70 mm ² - Ø10	70	52	21,5	10,5	11,5	20	11301065
Non-insulated tubular cable lugs 70 mm ² - Ø12	70	52	21,5	13,0	11,5	20	11301066
Non-insulated tubular cable lugs 70 mm ² - Ø14	70	62	21,5	14,5	11,5	20	11301067
Non-insulated tubular cable lugs 95 mm ² - Ø8	95	56	24,7	8,3	13,5	20	11301075
Non-insulated tubular cable lugs 95 mm ² - Ø10	95	56	24,7	10,5	13,5	20	11301076
Non-insulated tubular cable lugs 95 mm ² - Ø12	95	56	24,7	13,0	13,5	20	11301077
Non-insulated tubular cable lugs 95 mm ² - Ø14	95	67	24,7	14,5	13,5	20	11301078
Non-insulated tubular cable lugs 120 mm ² - Ø8	120	72	28,9	8,3	15,6	10	11301086
Non-insulated tubular cable lugs 120 mm ² - Ø10	120	72	28,9	10,5	15,6	10	11301087
Non-insulated tubular cable lugs 120 mm ² - Ø12	120	72	28,9	13,0	15,6	10	11301088
Non-insulated tubular cable lugs 120 mm ² - Ø14	120	72	28,9	14,5	15,6	10	11301089
Non-insulated tubular cable lugs 150 mm ² - Ø10	150	79	30,4	10,5	16,5	10	11301097
Non-insulated tubular cable lugs 150 mm ² - Ø12	150	79	30,4	13,0	16,5	10	11301098
Non-insulated tubular cable lugs 150 mm ² - Ø14	150	79	30,4	14,5	16,5	10	11301099
Non-insulated tubular cable lugs 185 mm ² - Ø12	185	85	34	13,0	18,4	10	11301107
Non-insulated tubular cable lugs 185 mm ² - Ø14	185	85	34	14,5	18,4	10	11301108
Non-insulated tubular cable lugs 185 mm ² - Ø16	185	85	34	16,5	18,4	10	11301109
Non-insulated tubular cable lugs 240 mm ² - Ø12	240	91	38,4	13,0	21,2	5	11301116
Non-insulated tubular cable lugs 240 mm ² - Ø14	240	91	38,4	14,5	21,2	5	11301117
Non-insulated tubular cable lugs 240 mm ² - Ø16	240	91	38,4	16,5	21,2	5	11301118
Non-insulated tubular cable lugs 300 mm ² - Ø16	300	97	41,7	16,5	23,4	5	11301123

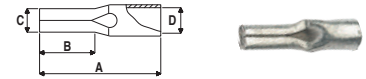

COPPER PIN TERMINAL

Description	Cable section (mm ²)	Length (mm)	Pin length (mm)	ø puntale (mm)	ø seat (mm)	Pack (pcs.)	Code
		A	B	C	D		
Copper pin terminal 10 mm ² - 24,1	10	24,1	13,2	4,3	4,8	100	11307010
Copper pin terminal 16 mm ² - 31	16	31	18,2	5,3	6	100	11307016
Copper pin terminal 25 mm ² - 38	25	38	18,5	7	7	100	11307025
Copper pin terminal 35 mm ² - 43,4	35	43,4	18,8	7	8,2	100	11307035
Copper pin terminal 50 mm ² - 50,5	50	50,5	19,2	8,4	9,5	50	11307050

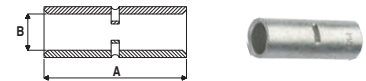

COPPER BUTT TUBE TERMINAL

Description	Cable section (mm ²)	Length (mm)	ø seat (mm)	Pack (pcs.)	Code
		A	B		
Copper butt tube terminal 6 mm ² - 25,5	6	25,5	3,5	100	11308003
Copper butt tube terminal 10 mm ² - 30	10	30	4,5	100	11308004
Copper butt tube terminal 16 mm ² - 32,5	16	32,5	5,5	100	11308005
Copper butt tube terminal 25 mm ² - 35,5	25	35,5	7	50	11308007
Copper butt tube terminal 35 mm ² - 40,5	35	40,5	8,5	50	11308008
Copper butt tube terminal 50 mm ² - 40,5	50	40,5	10	20	11308009
Copper butt tube terminal 70 mm ² - 45,5	70	45,5	11,5	20	11308010
Copper butt tube terminal 95 mm ² - 50,5	95	50,5	13,5	20	11308011
Copper butt tube terminal 120 mm ² - 65,5	120	65,5	15	10	11308012
Copper butt tube terminal 150 mm ² - 70,5	150	70,5	16,5	10	11308013
Copper butt tube terminal 185 mm ² - 75,5	185	75,5	19	10	11308014
Copper butt tube terminal 240 mm ² - 80,5	240	80,5	21	5	11308015
Copper butt tube terminal 300 mm ² - 90,5	300	90,5	23,5	5	11308016

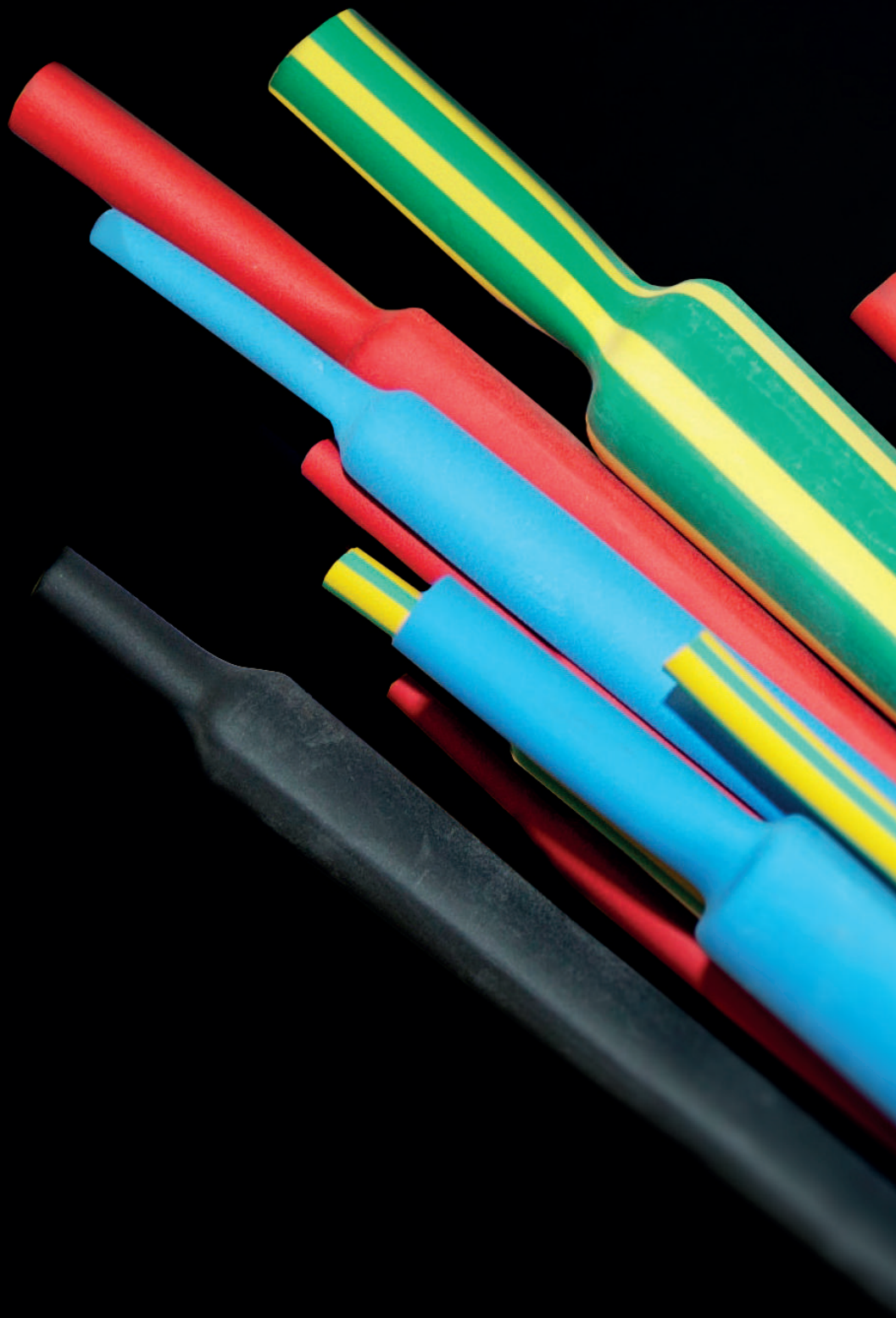

CABLE PROTECTION

HEAT-SHRINK TUBE

Guide to choose the right heat-shrink tube	64
EV 100	66
ET 100	68
ET 100 Assortment Display	71
EL 100	72
ET 301	74
Assortibox ET 100	76
Assortibox ET 301	77
EL 301A	78
EM 100A	80

NEOPRENE SLEEVES

Neoprene Sleeves	81
------------------	----

PVC SLEEVES

PVC Cable Protection Sleeve	82
-----------------------------	----

SPIRALS

Polyethylene Spiral Binding	83
-----------------------------	----

BRAIDED SLEEVES

Braided Sleeve	84
----------------	----

INSULATING TAPES

PVC Insulation Tape	86
Self-amalgamating Insulation Tape	88

How to choose the right heat-shrink tube

TECHNICAL CHARACTERISTICS

	PRODUCT	SHRINKING RATIO	OPERATING TEMPERATURE (C°)	SHRINKING TEMPERATURE (C°)	FLAME RATING (C°)	Ø AVAILABLE (mm)	CHARACTERISTICS	COLOURS	PACKAGING	PAGE
THIN WALL	EV 100	2:1	-30°C÷105°C	>90°C	-	1,6÷50,8	General purpose Competitive priced	Black	Reel Box 1 mtr length	66
	ET 100	2:1	-55°C÷135°C	>90°C	UL 224	1,2÷101,6	General purpose	Black Colours	Reel Box 1 mtr length	68
	EL 100	2:1	-55°C÷135°C	>90°C	UL 224 VW1	1,6÷101,6	Professional	Black	Reel Box	72
	ET 301	3:1	-55°C÷135°C	>100°C	UL 224	1,5÷39	General purpose high shrinking ratio	Black	Reel Box 1 mtr length	74
DUAL WALL THIN ADHESIVE-LINED	EL 301A	3:1	-55°C÷110°C	>100°C	UL 224 (parete esterna)	3÷24	Professional purpose adhesive-lined	Black	Box 1 mtr length	78
MEDIUM WALL WITH ADHESIVE	EM 100A	3:1	-40°C÷120°C	>110°C	-	12÷180	Heavy applications adhesive-lined	Black	1 mtr bag	80

In order to choose the right heat-shrink tubing size, it is necessary that the diameter of the shrunk tubing allows the perfect adhesion between the tubing and the cable diameter that has to be covered. This result is achieved when the tubing shrinks between 20% and 80% of its complete shrinkage capacity. Herewith some examples:

EXAMPLE 1

Image to have a cable of 10 mm diameter to be wrapped with a heat-shrink tubing with a shrinking ratio of 3:1; in theory both sizes 12/4 and 24/8 would be suitable, since the required diameter of 10 mm lies within the shrinking range of both tubing sizes:

Tubing type	Ø nominal max expanded (mm)	Ø nominal min recovered (mm)	Shrinkage capacity (mm)	Minimum shrinking (20%)	Maximum shrinking (80%)
12/4	12	4	8	10,4	5,6
24/8	24	8	16	20,8	11,2

The right heat-shrink tube is 12/4.

EXAMPLE 2

Image to have a cable of 5 mm diameter to be wrapped with a heat-shrink tubing with a shrinking ratio of 2:1; in theory both sizes 6,4/3,2 and 9,5/4,7 would be suitable, since the required diameter of 5 mm lies within the shrinking range of both tubing:

Tubing type	Ø nominal max expanded (mm)	Ø nominal min recovered (mm)	Shrinkage capacity (mm)	Minimum shrinking (20%)	Maximum shrinking (80%)
6,4/3,2	6,4	3,2	3,2	5,76	3,84
9,5/4,7	9,5	4,7	4,7	8,56	5,74

The right heat-shrink tube is 6,4/3,2.

COMPLETE EXAMPLE - THIN AND DUAL WALL TUBING

Tubing type	Shrinking ratio	Ø nominal max expanded (mm)	Ø nominal min recovered (mm)	Shrinkage capacity (mm)	Minimum shrinking (20%)	Maximum shrinking (80%)
1,2/0,6	2:1	1,2	0,6	0,6	0,72	1,08
1,6/0,8		1,6	0,8	0,8	0,96	1,44
2,4/1,2		2,4	1,2	1,2	1,44	2,16
3,2/1,6		3,2	1,6	1,6	1,92	2,88
4,8/2,4		4,8	2,4	2,4	2,88	4,32
6,4/3,2		6,4	3,2	3,2	3,84	5,76
9,5/4,7		9,5	4,7	4,8	5,66	8,54
12,7/6,4		12,7	6,4	6,3	7,66	11,44
19,1/9,5		19,1	9,5	9,6	11,42	17,18
25,4/12,7		25,4	12,7	12,7	15,24	22,86
38,1/19,1		38,1	19,1	19,0	22,90	34,30
50,8/25,4		50,8	25,4	25,4	30,48	45,72
76,2/38,1		76,2	38,1	38,1	45,72	68,58
101,6/50,8		101,6	50,7	50,8	60,96	91,44
1,5/0,5		3:1	1,5	0,5	1	0,70
3/1	3,0		1,0	2	1,40	2,60
4,8/1,6	4,8		1,6	3,2	2,24	4,16
6/2	6,0		2,0	4	2,80	5,20
9/3	9		3	6	4,20	7,80
12/4	12,0		4,0	8	5,60	10,40
18/6	18		6	12	8,40	15,60
24/8	24,0		8,0	16	11,20	20,80
39/13	39,0		13,0	26	18,20	33,80

EV 100

Thin wall heat-shrink tube 2:1, halogen free

CABLE PROTECTION

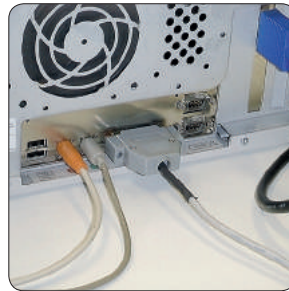

Features and benefits

- Halogen free
- Thin flexible tubing in cross-linked polyolefin

Applications

- Electrical insulation in the cable connection
- Cable protection
- General purpose

Technical data

Shrinkage ratio	2:1
Available diameters	Ø 1,6mm ÷ Ø 50,8mm
Available colours	black
Halogen	absent
Working temperature	-30°C ÷ +105°C
Shrinkage temperature	>90°C
Fire resistance	FMVSS 302
Longitudinal withdrawal	-10% ÷ +5%
Dielectric strength	>20kV/mm

Approvals and certifications

FMVSS 302



EV 100

BLACK - REEL

Description	Ø internal expanded (inch)	Ø internal expanded (mm)	Ø internal recovered (mm)	Wall recovered thickness (mm)	Pack (m)	Code
EV100 1,6/0,8	1/16"	1,6	0,8	0,43	200	12201016
EV100 2,4/1,2	3/32"	2,4	1,2	0,51	200	12201024
EV100 3,2/1,6	1/8"	3,2	1,6	0,51	200	12201032
EV100 4,8/2,4	3/16"	4,8	2,4	0,51	200	12201048
EV100 6,4/3,2	1/4"	6,4	3,2	0,64	150	12201064
EV100 9,5/4,7	3/8"	9,5	4,7	0,64	150	12201095
EV100 12,7/6,4	1/2"	12,7	6,4	0,64	100	12201127
EV100 19,1/9,5	3/4"	19,1	9,5	0,77	50	12201190
EV100 25,4/12,7	1"	25,4	12,7	0,89	50	12201254
EV100 38,1/19,1	1 1/2"	38,1	19,1	1,02	25	12201381
EV100 50,8/25,4	2"	50,8	25,4	1,14	25	12201508



EV 100

BLACK - BOX

Description	Ø internal expanded (inch)	Ø internal expanded (mm)	Ø internal recovered (mm)	Wall recovered thickness (mm)	Pack (m)	Code
EV100 1,6/0,8	1/16"	1,6	0,8	0,43	15	12251016
EV100 2,4/1,2	3/32"	2,4	1,2	0,51	15	12251024
EV100 3,2/1,6	1/8"	3,2	1,6	0,51	15	12251032
EV100 4,8/2,4	3/16"	4,8	2,4	0,51	12	12251048
EV100 6,4/3,2	1/4"	6,4	3,2	0,64	12	12251064
EV100 9,5/4,7	3/8"	9,5	4,7	0,64	10	12251095
EV100 12,7/6,4	1/2"	12,7	6,4	0,64	8	12251127
EV100 19,1/9,5	3/4"	19,1	9,5	0,77	5	12251190
EV100 25,4/12,7	1"	25,4	12,7	0,89	3	12251254

EV 100

BLACK - 1 METRE TUBING - BOX

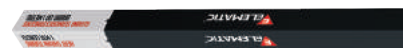

Description	Ø internal expanded (inch)	Ø internal expanded (mm)	Ø internal recovered (mm)	Wall recovered thickness (mm)	Pack (m)	Code
EV100 1,6/0,8	1/16"	1,6	0,8	0,43	30	12271016
EV100 2,4/1,2	3/32"	2,4	1,2	0,51	30	12271024
EV100 3,2/1,6	1/8"	3,2	1,6	0,51	30	12271032
EV100 4,8/2,4	3/16"	4,8	2,4	0,51	24	12271048
EV100 6,4/3,2	1/4"	6,4	3,2	0,64	24	12271064
EV100 9,5/4,7	3/8"	9,5	4,7	0,64	20	12271095
EV100 12,7/6,4	1/2"	12,7	6,4	0,64	16	12271127
EV100 19,1/9,5	3/4"	19,1	9,5	0,77	10	12271190
EV100 25,4/12,7	1"	25,4	12,7	0,89	6	12271254

ET 100

Coloured thin wall heat-shrink tube
2:1 - Self-extinguishing



CABLE PROTECTION

Features and benefits

- Thin flexible tubing in cross-linked polyolefin. Good mechanical strength, chemical resistant
- Self-extinguishing according to UL224 and available in different colors

Technical data

Shrinkage ratio	2:1
Available diameters	Ø 1,2mm ÷ Ø 101,6mm
Available colours*	black, white, red, blue, transparent, yellow/green
Halogen	absent
Working temperature	-55°C ÷ +135°C
Shrinkage temperature	>90°C
Fire resistance	Self-extinguishing according to UL224 (except transparent)
Longitudinal withdrawal	-5% ÷ +5%
Dielectric strength	>20kV/mm

* For colors other than black, add the color code to the article code: BI = white, BL = blue, R = red, TR = transparent

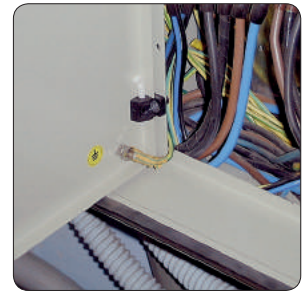

Applications

- Electrical and mechanical protection of cables
- Permanent electrical insulation
- Applications requiring self-extinguishing properties
- Cabling identification

Approvals and certifications

UL224 125°C - UL cert.E 228117*

CSA C22.22 N. 198.1-98 OFT*

*except transparent



EN 60684-2-209

Hot air guns
page 201



ET 100 BLACK - REEL

Description	Ø internal expanded (inch)	Ø internal expanded (mm)	Ø internal recovered (mm)	Wall recovered thickness (mm)	Pack (m)	Code
ET 100 1,2/0,6	3/64"	1,2	0,6	0,41	200	12203012
ET 100 1,6/0,8	1/16"	1,6	0,8	0,43	200	12203016
ET 100 2,4/1,2	3/32"	2,4	1,2	0,51	200	12203024
ET 100 3,2/1,6	1/8"	3,2	1,6	0,51	200	12203032
ET 100 4,8/2,4	3/16"	4,8	2,4	0,51	200	12203048
ET 100 6,4/3,2	1/4"	6,4	3,2	0,64	150	12203064
ET 100 9,5/4,7	3/8"	9,5	4,7	0,64	150	12203095
ET 100 12,7/6,4	1/2"	12,7	6,4	0,64	100	12203127
ET 100 19,1/9,5	3/4"	19,1	9,5	0,77	50	12203190
ET 100 25,4/12,7	1"	25,4	12,7	0,89	50	12203254
ET 100 38,1/19,1	1 1/2"	38,1	19,1	1,02	25	12203381
ET 100 50,8/25,4	2"	50,8	25,4	1,14	25	12203508
ET 100 76,2/38,1	3"	76,2	38,1	1,27	15	12203762
ET 100 101,6/50,8	4"	101,6	50,8	1,4	15	12203994

ET 100 BLACK - BOX



Description	Ø internal expanded (inch)	Ø internal expanded (mm)	Ø internal recovered (mm)	Wall recovered thickness (mm)	Pack (m)	Code
ET 100 1,2/0,6	3/64"	1,2	0,6	0,41	15	12253012
ET 100 1,6/0,8	1/16"	1,6	0,8	0,43	15	12253016
ET 100 2,4/1,2	3/32"	2,4	1,2	0,51	15	12253024
ET 100 3,2/1,6	1/8"	3,2	1,6	0,51	15	12253032
ET 100 4,8/2,4	3/16"	4,8	2,4	0,51	12	12253048
ET 100 6,4/3,2	1/4"	6,4	3,2	0,64	12	12253064
ET 100 9,5/4,7	3/8"	9,5	4,7	0,64	10	12253095
ET 100 12,7/6,4	1/2"	12,7	6,4	0,64	8	12253127
ET 100 19,1/9,5	3/4"	19,1	9,5	0,77	5	12253190
ET 100 25,4/12,7	1"	25,4	12,7	0,89	3	12253254

* For colors other than black, add the color code to the article code: BI = white, BL = blue, R = red, TR = transparent

ET 100 BLACK - 1 METRE TUBING - BOX

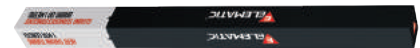

Description	Ø internal expanded (inch)	Ø internal expanded (mm)	Ø internal recovered (mm)	Wall recovered thickness (mm)	Pack (m)	Code
ET 100 1,2/0,6	3/64"	1,2	0,6	0,41	30	12273012
ET 100 1,6/0,8	1/16"	1,6	0,8	0,43	30	12273016
ET 100 2,4/1,2	3/32"	2,4	1,2	0,51	30	12273024
ET 100 3,2/1,6	1/8"	3,2	1,6	0,51	30	12273032
ET 100 4,8/2,4	3/16"	4,8	2,4	0,51	24	12273048
ET 100 6,4/3,2	1/4"	6,4	3,2	0,64	24	12273064
ET 100 9,5/4,7	3/8"	9,5	4,7	0,64	20	12273095
ET 100 12,7/6,4	1/2"	12,7	6,4	0,64	16	12273127
ET 100 19,1/9,5	3/4"	19,1	9,5	0,77	10	12273190
ET 100 25,4/12,7	1"	25,4	12,7	0,89	6	12273254
ET 100 38,1/19,1	1 1/2"	38,1	19,1	1,02	4	12273381
ET 100 50,8/25,4	2"	50,8	25,4	1,14	3*	12273508
ET 100 76,2/38,1	3"	76,2	38,1	1,27	3*	12273762
ET 100 101,6/50,8	4"	101,6	50,8	1,4	3*	12273994

* Pack in plastic bag. Codes 12273762 and 12273994 available only in black



ET 100 YELLOW/GREEN - REEL

Description	Ø internal expanded (inch)	Ø internal expanded (mm)	Ø internal recovered (mm)	Wall recovered thickness (mm)	Pack (m)	Code
ET 100 2,4/1,2	3/32"	2,4	1,2	0,51	200	12203024 G/V
ET 100 3,2/1,6	1/8"	3,2	1,6	0,51	200	12203032 G/V
ET 100 4,8/2,4	3/16"	4,8	2,4	0,51	200	12203048 G/V
ET 100 6,4/3,2	1/4"	6,4	3,2	0,64	150	12203064 G/V
ET 100 9,5/4,7	3/8"	9,5	4,7	0,64	150	12203095 G/V
ET 100 12,7/6,4	1/2"	12,7	6,4	0,64	100	12203127 G/V
ET 100 19,1/9,5	3/4"	19,1	9,5	0,77	50	12203190 G/V
ET 100 25,4/12,7	1"	25,4	12,7	0,89	50	12203254 G/V
ET 100 38,1/19,1	1 1/2"	38,1	19,1	1,02	25	12203381 G/V
ET 100 50,8/25,4	2"	50,8	25,4	1,14	25	12203508 G/V



ET 100 YELLOW/GREEN - BOX

Description	Ø internal expanded (inch)	Ø internal expanded (mm)	Ø internal recovered (mm)	Wall recovered thickness (mm)	Pack (m)	Code
ET 100 2,4/1,2	3/32	2,4	1,2	0,51	15	12253024 G/V
ET 100 3,2/1,6	1/8	3,2	1,6	0,51	15	12253032 G/V
ET 100 4,8/2,4	3/16	4,8	2,4	0,51	12	12253048 G/V
ET 100 6,4/3,2	1/4	6,4	3,2	0,64	12	12253064 G/V
ET 100 9,5/4,7	3/8	9,5	4,7	0,64	10	12253095 G/V
ET 100 12,7/6,4	1/2	12,7	6,4	0,64	8	12253127 G/V
ET 100 19,1/9,5	3/4	19,1	9,5	0,77	5	12253190 G/V
ET 100 25,4/12,7	1	25,4	12,7	0,89	3	12253254 G/V

ET 100 YELLOW/GREEN - 1 METRE TUBING - BOX



Description	Ø internal expanded (inch)	Ø internal expanded (mm)	Ø internal recovered (mm)	Wall recovered thickness (mm)	Pack (m)	Code
ET 100 1,2/0,6	3/64	1,2	0,6	0,41	30	12273012 G/V
ET 100 1,6/0,8	1/16	1,6	0,8	0,43	30	12273016 G/V
ET 100 2,4/1,2	3/32	2,4	1,2	0,51	30	12273024 G/V
ET 100 3,2/1,6	1/8	3,2	1,6	0,51	30	12273032 G/V
ET 100 4,8/2,4	3/16	4,8	2,4	0,51	24	12273048 G/V
ET 100 6,4/3,2	1/4	6,4	3,2	0,64	24	12273064 G/V
ET 100 9,5/4,7	3/8	9,5	4,7	0,64	20	12273095 G/V
ET 100 12,7/6,4	1/2	12,7	6,4	0,64	16	12273127 G/V
ET 100 19,1/9,5	3/4	19,1	9,5	0,77	10	12273190 G/V
ET 100 25,4/12,7	1	25,4	12,7	0,89	6	12273254 G/V
ET 100 38,1/19,1	1 1/2	38,1	19,1	1,02	4	12273381 G/V
ET 100 50,8/25,4	2	50,8	25,4	1,14	3*	12273508 G/V

* Pack in plastic bag.

ET100 Assortment Display

Floor display with 1m heat-shrink tube boxes



Display technical data

Height	1.740 mm
Width	415 mm
Depth	345 mm
Assortment	24 boxes - 1 meter bars

Note:

Code 8221705 for single display without set-up.
For personalization contact our sales offices.

ET 100 ASSORTMENT DISPLAY

Description	Code
ASSORTMENT DISPLAY ET 100 WITH DISPLAY	KIT 8221705

Composition:

Color	Ø internal expanded/ recovered (mm)	Quantity (m)	Code
●	1,6 / 0,8	30	12273016
●	2,4 / 1,2	30	12273024
●	3,2 / 1,6	30	12273032
●	4,8 / 2,4	24	12273048
●	6,4 / 3,2	24	12273064
●	9,5 / 4,8	20	12273095
●	12,7 / 6,4	16	12273127
●	19,1 / 9,5	10	12273190
●	25,4 / 12,7	6	12273254
●	4,8 / 2,4	24	12273048 G/V
●	6,4 / 3,2	24	12273064 G/V
●	9,5 / 4,7	20	12273095 G/V
●	12,7 / 6,4	16	12273127 G/V
●	19,1 / 9,5	10	12273190 G/V
●	4,8 / 2,4	24	12273048 BL
●	6,4 / 3,2	24	12273064 BL
●	9,5 / 4,7	20	12273095 BL
●	12,7 / 6,4	16	12273127 BL
●	19,1 / 9,5	10	12273190 BL
●	4,8 / 2,4	24	12273048 R
●	6,4 / 3,2	24	12273064 R
●	9,5 / 4,7	20	12273095 R
●	12,7 / 6,4	16	12273127 R
●	19,1 / 9,5	10	12273190 R

EL 100

Professional thin wall heat-shrink tube
2:1- highly self-extinguishing

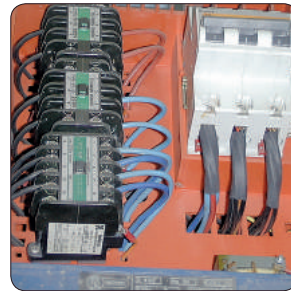

CABLE PROTECTION

Features and benefits

- Thin flexible tubing in cross-linked polyolefin. High mechanical performances, chemical resistant to different substance and solvents
- Self-extinguishing according to UL224 VW-1

Technical data

Shrinkage ratio	2:1
Available diameters	Ø 1,6mm ÷ Ø 101,6mm
Available colours	black
Working temperature	-55°C ÷ +135°C
Shrinkage temperature	>90°C
Fire resistance	Self-extinguishing according to UL224 VW-1
Longitudinal withdrawal	-5% +5%
Dielectric strength	>20kV/mm

Applications

- Electrical and mechanical protection of cables
- Applications requiring self-extinguishing properties
- Permanent electrical insulation
- Cable bundling

Approvals and certifications

UL224 125°C VW1 - UL cert.E 228117
CSA C22.22 N. 198.1-98 OFT





EL 100

BLACK - REEL

Description	Ø internal expanded (inch)	Ø internal expanded (mm)	Ø internal recovered (mm)	Wall recovered thickness (mm)	Pack (m)	Code
EL 100 1,6/0,8	1/16"	1,6	0,8	0,43	200	12204016
EL 100 2,4/1,2	3/32"	2,4	1,2	0,51	200	12204024
EL 100 3,2/1,6	1/8"	3,2	1,6	0,51	200	12204032
EL 100 4,8/2,4	3/16"	4,8	2,4	0,51	200	12204048
EL 100 6,4/3,2	1/4"	6,4	3,2	0,64	150	12204064
EL 100 9,5/4,7	3/8"	9,5	4,7	0,64	150	12204095
EL 100 12,7/6,4	1/2"	12,7	6,4	0,64	100	12204127
EL 100 19,1/9,5	3/4"	19,1	9,5	0,77	50	12204190
EL 100 25,4/12,7	1"	25,4	12,7	0,89	50	12204254
EL 100 38,1/19,1	1 1/2"	38,1	19,1	1,02	25	12204381
EL 100 50,8/25,4	2"	50,8	25,4	1,14	25	12204508
EL 100 76,2/38,1	3"	76,2	38,1	1,27	15	12204762
EL 100 101,6/50,8	4"	101,6	50,8	1,4	15	12204994

EL 100

BLACK - BOX



Description	Ø internal expanded (inch)	Ø internal expanded (mm)	Ø internal recovered (mm)	Wall recovered thickness (mm)	Pack (m)	Code
EL 100 1,6/0,8	1/16"	1,6	0,8	0,43	15	12254016
EL 100 2,4/1,2	3/32"	2,4	1,2	0,51	15	12254024
EL 100 3,2/1,6	1/8"	3,2	1,6	0,51	15	12254032
EL 100 4,8/2,4	3/16"	4,8	2,4	0,51	12	12254048
EL 100 6,4/3,2	1/4"	6,4	3,2	0,64	12	12254064
EL 100 9,5/4,7	3/8"	9,5	4,7	0,64	10	12254095
EL 100 12,7/6,4	1/2"	12,7	6,4	0,64	8	12254127
EL 100 19,1/9,5	3/4"	19,1	9,5	0,77	5	12254190
EL 100 25,4/12,7	1"	25,4	12,7	0,89	3	12254254

ET 301

Thin wall heat-shrink tube 3:1 - self-extinguishing

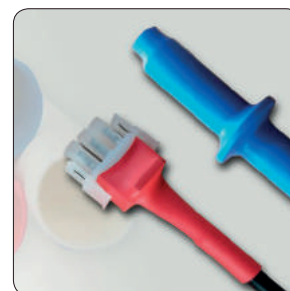

CABLE PROTECTION

Features and benefits

- High shrink ratio tubing in cross-linked polyolefin. High mechanical performances, chemical resistant to different substance and solvents
- Self-extinguishing according to UL224

Technical data

Shrinkage ratio	3:1
Available diameters	Ø 1,5mm ÷ Ø 39mm
Available colours	black
Working temperature	-55°C ÷ +135°C
Shrinkage temperature	>90°C
Fire resistance	Self-extinguishing according to UL224
Longitudinal withdrawal	+1% -10%
Dielectric strength	>20kV/mm

Applications

- Electrical and mechanical protection of cables
- Applications requiring self-extinguishing properties
- Permanent Electrical Insulation

Approvals and certifications

UL224 125°C - UL cert.E 228117
 CSA C22.22 N. 198.1-98 OFT





ET 301

BLACK - REEL

Description	Ø internal expanded (mm)	Ø internal recovered (mm)	Wall recovered thickness (mm)	Pack (m)	Code
ET 301 1,5/0,5	1,5	0,5	0,45	200	12205015
ET 301 3/1	3	1	0,55	200	12205030
ET 301 6/2	6	2	0,70	150	12205060
ET 301 9/3	9	3	0,70	150	12205090
ET 301 12/4	12	4	0,70	100	12205120
ET 301 18/6	18	6	0,80	50	12205180
ET 301 24/8	24	8	1,00	50	12205240
ET 301 39/13	39	13	1,15	30	12205390



ET 301

BLACK - BOX

Description	Ø internal expanded (mm)	Ø internal recovered (mm)	Wall recovered thickness (mm)	Pack (m)	Code
ET 301 1,5/0,5	1,5	0,5	0,45	15	12255015
ET 301 3/1	3	1	0,55	15	12255030
ET 301 6/2	6	2	0,70	10	12255060
ET 301 9/3	9	3	0,70	8	12255090
ET 301 12/4	12	4	0,70	7	12255120
ET 301 18/6	18	6	0,80	4	12255180
ET 301 24/8	24	8	1,00	3	12255240

ET 301

BLACK - 1 METRE TUBING - BOX



Description	Ø internal expanded (mm)	Ø internal recovered (mm)	Wall recovered thickness (mm)	Pack (m)	Code
ET 301 1,5/0,5	1,5	0,5	0,45	30	12275015
ET 301 3/1	3	1	0,55	30	12275030
ET 301 6/2	6	2	0,70	24	12275060
ET 301 9/3	9	3	0,70	20	12275090
ET 301 12/4	12	4	0,70	16	12275120
ET 301 18/6	18	6	0,80	10	12275180
ET 301 24/8	24	8	1,00	6	12275240
ET 301 39/13	39	13	1,15	4*	12275390

* Pack in plastic bag.

Assortibox ET 100

Thin wall heat-shrink tube assortment, self-extinguishing, general purpose, with multifunctional gas tool



Technical data

Shrinkage ratio	2:1
Available diameters	Ø 1,2/0,6 ÷ Ø 19,1/9,5mm
Available colours	black, white, red, blue, transparent, yellow/green
Halogen	absent
Working temperature	-55°C ÷ +135°C
Shrinkage temperature	>90°C
Fire resistance	Self-extinguishing according to UL224 (except transparent)
Longitudinal withdrawal	-5% ÷ +5%
Dielectric strength	>20kV/mm

ET 100 ASSORTMENT BOX - 406 PCS

Description	Pack (pcs.)	Code
ET 100 ASSORTIBOX	406	12233001

Composition:

Color	Ø sleeve (mm)	Sleeve length (mm)	Quantity (pcs.)	Code
●	1,2/0,6	50	25	-
∅	1,2/0,6	50	25	-
●	1,2/0,8	50	25	-
∅	1,2/0,8	50	25	-
●	1,2/0,8	50	25	-
∅	2,4/1,2	50	20	-
○	2,4/1,2	50	20	-
○	2,4/1,2	50	20	-
●	3,2/1,6	50	50	-
●	4,8/2,4	50	40	-
●	6,4/3,2	50	15	-
∅	6,4/3,2	50	15	-
●	9,5/4,7	50	15	-
●	9,5/4,7	50	15	-
●	9,5/4,7	50	15	-
●	9,5/4,7	50	15	-
●	12,7/6,4	100	10	-
●	19,1/9,5	200	6	-

Assortibox ET 301

Thin wall heat-shrink tube assortment,
high shrink ratio, self-extinguishing,
general purpose, with multifunctional gas
tool



Technical data

Shrinkage ratio	3:1
Available diameters	Ø 1,5/0,5 ÷ Ø 24/8mm
Available colours	black, white, red, blue, brown, yellow/green
Halogen	absent
Working temperature	-55°C ÷ +135°C
Shrinkage temperature	>90°C
Fire resistance	Self-extinguishing according to UL224
Longitudinal withdrawal	+1% -10%
Dielectric strength	>20kV/mm

ET 301 ASSORTMENT BOX - 170 PCS

Description	Pack (pcs.)	Code
ET 301 ASSORTIBOX	170	12235001

Composition:

Color	Ø sleeve (mm)	Sleeve length (mm)	Quantity (pcs.)	Code
●	1,5/0,5	40	10	-
●	1,5/0,5	40	5	-
●	1,5/0,5	40	5	-
●	1,5/0,5	40	5	-
●	1,5/0,5	40	5	-
●	3/1	40	20	-
●	3/1	40	5	-
●	3/1	40	5	-
●	3/1	40	5	-
●	3/1	40	5	-
●	6/2	40	20	-
●	6/2	40	5	-
●	6/2	40	5	-
●	6/2	40	5	-
●	6/2	40	5	-
●	9/3	80	5	-
●	9/3	80	2	-
●	9/3	80	2	-
●	9/3	80	2	-
●	9/3	80	2	-
●	12/4	80	5	-
●	12/4	80	2	-
●	12/4	80	2	-
●	12/4	80	2	-
●	12/4	80	2	-
●	18/6	120	10	-
●	18/6	80	2	-
●	18/6	80	2	-
●	18/6	80	2	-
●	18/6	80	2	-
●	24/8	170	8	-
●	24/8	120	2	-
●	24/8	120	2	-
●	24/8	120	2	-
●	24/8	120	2	-

EL 301A

Dual wall heat-shrink tube 3:1,
with adhesive liner



Features and benefits

- High shrink ratio tubing in cross-linked polyolefin
- Good insulating performances. Sealing and high protection against humidity and external agents
- Good mechanical and chemical resistance
- Outer jacket self-extinguishing

Technical data

Shrinkage ratio	3:1
Available diameters	Ø 3mm ÷ Ø 24mm
Available colours	black
Working temperature	-55°C ÷ +110°C
Shrinkage temperature	>100°C
Fire resistance	Self-extinguishing (outer jacket)
Longitudinal withdrawal	-10% ÷ +1%
Dielectric strength	>20kV/mm

Applications

- Permanent electrical insulation and mechanical protection of cables and cables joints
- Protections in electronic applications

Approvals and certifications

EN 60684-2-248

EL 301A
BLACK - BOX

Description	Ø internal expanded (mm)	Ø internal recovered (mm)	Wall recovered thickness (mm)	Pack (m)	Code
EL 301A 3/1	3	1	1	15	12256030
EL 301A 6/2	6	2	1,1	12	12256060
EL 301A 9/3	9	3	1,3	10	12256090
EL 301A 12/4	12	4	1,7	8	12256120
EL 301A 18/6	18	6	2	5	12256180
EL 301A 24/8	24	8	2,5	3	12256240

EL 301A
BLACK - 1 METRE TUBING - BOX

Description	Ø internal expanded (mm)	Ø internal recovered (mm)	Wall recovered thickness (mm)	Pack (m)	Code
EL 301A 3/1	3	1	1	30	12276030
EL 301A 6/2	6	2	1,1	24	12276060
EL 301A 9/3	9	3	1,3	20	12276090
EL 301A 12/4	12	4	1,7	16	12276120
EL 301A 18/6	18	6	2	10	12276180
EL 301A 24/8	24	8	2,5	6	12276240

EM 100A

Medium wall heat-shrink tube up to 4:1, with adhesive liner



CABLE PROTECTION

Features and benefits

- High shrink ratio tubing in cross-linked polyolefin
- Excellent electrical insulating performances
- Sealing and high protection against humidity and external agents
- High mechanical and chemical resistances

Technical data

Shrinkage ratio	3:1 - 4:1
Available diameters	Ø 12mm ÷ Ø 180mm
Available colours	black
Working temperature	-40°C ÷ +120°C
Shrinkage temperature	>110°C
Fire resistance	Not self-extinguishing
Longitudinal withdrawal	-10% ÷ 0%
Dielectric strength	>17kV/mm

Applications

- Insulation and protection of low voltage cable and cable joints
- Suitable for application in power switchgear and controlgear assemblies

Hot air guns
page 201

EM 100A BLACK - 1 METRE TUBING - BOX



Description	Ø internal expanded (mm)	Ø internal recovered (mm)	Wall recovered thickness (mm)	Pack (m)	Code
EM 100A 12/3	12	3	2,2	25	12247012
EM 100A 22/6	22	6	2,3	15	12247019
EM 100A 33/8	33	8	2,6	10	12247030
EM 100A 40/12	40	12	2,6	5	12247040
EM 100A 55/17	55	17	2,9	3	12247050
EM 100A 65/19	65	19	3,2	3	12247063
EM 100A 72/22	72	22	3,2	2	12247070
EM 100A 92/26	92	26	3,2	1	12247095
EM 100A 115/35	115	35	3,4	1	12247115
EM 100A 180/60	180	60	3,5	1	12247140

Neoprene Sleeves

Sleeves in lubricated neoprene
for easy installing



Features and benefits

- Internally lubricated for an easy application
- Resistant to oil and solvents
- Good resistance to humidity and ageing
- Suitable for low temperature application

Applications

- Connectors protection
- Industrial wiring
- Application in switchgears and cabinets

Technical data

Material	lubricated neoprene
Available diameters	from Ø 1,75 to Ø 17 mm
Available colours	black
Working temperature	-30°C ÷ +90°C
Fire resistance	UL 94 class V0
Dielectric strength	13 kV/mm

Hot air guns
page 201

NEOPRENE SLEEVE

Description	Internal ø (mm)	External ø (mm)	Length (mm)	Thickness (mm)	Pack (pcs.)	Code
Neoprene sleeve 1,75 x 20	1,8	3,5	20	0,5	1.000	5381
Neoprene sleeve 2,5 x 25	2,5	5,5	25	0,9	1.000	5382
Neoprene sleeve 3 x 25	3	6	25	0,6	1.000	5383
Neoprene sleeve 4 x 30	4	8	30	1,2	1.000	5384
Neoprene sleeve 5 x 25	5	9	25	0,7	1.000	5385
Neoprene sleeve 7,5 x 30	7,5	12	30	0,8	1.000	5386
Neoprene sleeve 10 x 35	10	15	35	0,9	500	5387
Neoprene sleeve 12 x 50	12	20	50	1,2	500	5388
Neoprene sleeve 17 x 50	17	28	50	1,3	500	5390

PVC Cable Protection Sleeve

PVC sleeve suitable for protection against abrasion



Features and benefits

- Easy insertion
- Resistant to ozone, ageing and weak acids

Applications

- Applications in switchgears and cabinets
- Industrial wiring
- Cable harness in automotive applications

Technical data

Material	PVC
Available diameters	from Ø 3 to Ø 50 mm
Available colours	black
Working temperature	-40°C ÷ +70°C
Fire resistance	UL 94 class V1
Dielectric strength	25 kV/mm



PVC SLEEVES

Description	Internal ø (mm)	External ø (mm)	Thickness (mm)	Pack (m)	Code
PVC sleeve 3 x 0,3	3	3,6	0,3	200	12370300
PVC sleeve 4 x 0,3	4	4,6	0,3	200	12370400
PVC sleeve 5 x 0,4	5	5,8	0,4	200	12370500
PVC sleeve 6 x 0,4	6	6,8	0,4	200	12370600
PVC sleeve 7 x 0,4	7	7,8	0,4	200	12370700
PVC sleeve 8 x 0,4	8	8,8	0,4	200	12370800
PVC sleeve 10 x 0,5	10	11	0,5	200	12370101
PVC sleeve 12 x 0,5	12	13	0,5	100	12370121
PVC sleeve 14 x 0,6	14	15,2	0,6	100	12370141
PVC sleeve 16 x 0,6	16	17,2	0,6	100	12370161
PVC sleeve 18 x 0,7	18	19,4	0,7	100	12370181
PVC sleeve 20 x 0,8	20	21,6	0,8	100	12370202
PVC sleeve 22 x 0,9	22	23,8	0,9	100	12370222
PVC sleeve 24 x 0,9	24	25,8	0,9	50	12370242
PVC sleeve 26 x 0,9	26	27,8	0,9	50	12370262
PVC sleeve 28 x 1,2	28	30	1	50	12370282
PVC sleeve 30 x 1,3	30	32	1	50	12370303
PVC sleeve 40 x 1,2	40	42,5	1,2	25	12370404
PVC sleeve 50 x 1,3	50	52,6	1,3	25	12370505

Polyethylene Spiral Binding

LDPE spiral binding for protecting and managing cables and cable bundles

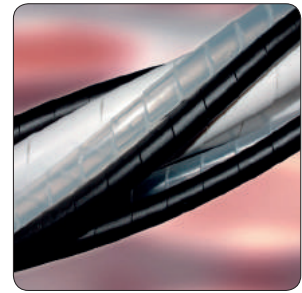

Features and benefits

- Extremely flexible
- Quick installation in definitive wiring
- Easy to branch out the cable at any point

Technical data

Material	low density polyethylene
Available diameters	from Ø 3 to Ø 150 mm
Available colours	black and transparent
Working temperature	-50°C a 85°C
Fire resistance	UL 94 class HB
Halogen	Absent

Applications

- Organising and protecting cables in switchgear and electrical cabinets
- Industrial wiring

POLYETHYLENE SPIRAL

Description	Color	Internal ø (mm)	External ø (mm)	Thickness (mm)	Ø bundle Min/Max (mm)	Pack (m)	Code
Polyethylene spiral 3 ÷ 15 natural	●	2,3	3,5	0,6	3 ÷ 15	50	SP 2
Polyethylene spiral 4 ÷ 20 natural	●	3,7	5	0,65	4 ÷ 20	25	SP 4
Polyethylene spiral 7 ÷ 40 natural	●	6,5	8	0,75	7 ÷ 40	25	SP 6
Polyethylene spiral 9 ÷ 50 natural	●	8,2	10	0,85	9 ÷ 50	25	SP 9
Polyethylene spiral 11 ÷ 70 natural	●	10	12	1	11 ÷ 70	25	SP 12
Polyethylene spiral 13 ÷ 80 natural	●	12	14	1	13 ÷ 80	20	SP 15
Polyethylene spiral 18 ÷ 120 natural	●	17,6	20	1,2	18 ÷ 120	25	SP 20
Polyethylene spiral 23 ÷ 150 natural	●	22,2	25	1,4	23 ÷ 150	20	SP 25
Polyethylene spiral 3 ÷ 15 black	●	2,3	3,5	0,6	3 ÷ 15	50	SP 2N
Polyethylene spiral 4 ÷ 20 black	●	3,7	5	0,65	4 ÷ 20	25	SP 4N
Polyethylene spiral 7 ÷ 40 black	●	6,5	8	0,75	7 ÷ 40	25	SP 6N
Polyethylene spiral 9 ÷ 50 black	●	8,2	10	0,85	9 ÷ 50	25	SP 9N
Polyethylene spiral 11 ÷ 70 black	●	10	12	1	11 ÷ 70	25	SP 12N
Polyethylene spiral 13 ÷ 80 black	●	12	14	1	13 ÷ 80	20	SP 15N
Polyethylene spiral 18 ÷ 120 black	●	17,6	20	1,2	18 ÷ 120	25	SP 20N
Polyethylene spiral 23 ÷ 150 black	●	22,2	25	1,4	23 ÷ 150	20	SP 25N

Braided Sleeve

Braided sleeving for mechanical protection of cables and for cable bundling

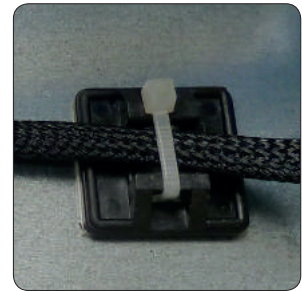
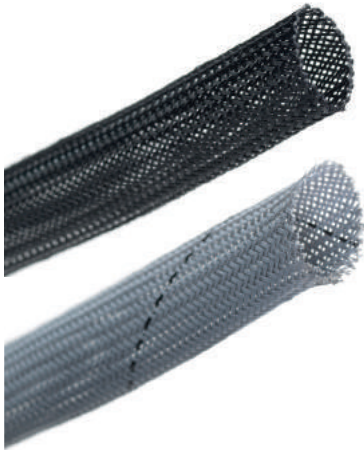

Features and benefits

- Easy insertion
- Resistant to abrasion

Applications

- Protection of cables in switchgears
- Industrial wiring

Technical data

POLYESTER VERSION

Material	Polyester
Thread diameters	0,22 mm
Working temperature	-40°C ÷ +150°C
Available diameters	from Ø 6 to Ø 40 mm
Fire resistance	UL 94 class V2
Halogen	Absent

POLYAMIDE 6.6 VERSION

Material	Polyamide 6.6
Thread diameters	0,25 mm
Working temperature	-40°C ÷ +125°C
Available diameters	from Ø 6 to Ø 40 mm
Fire resistance	UL 94 class V2
Halogen	Absent

Approvals and certifications

For polyester version:

EN 45545-21 (HL3)

DIN 5510-2



BRAIDED SLEEVE POLYESTER

Description	Color	Ø bundle Min/Max (mm)	Pack (m)	Code
Polyester braided sleeve 6 - grey	●	6 ÷ 12	100	15501006
Polyester braided sleeve 8 - grey	●	8 ÷ 15	100	15501008
Polyester braided sleeve 10 - grey	●	10 ÷ 18	100	15501010
Polyester braided sleeve 12 - grey	●	12 ÷ 22	50	15501012
Polyester braided sleeve 15 - grey	●	15 ÷ 25	50	15501015
Polyester braided sleeve 18 - grey	●	18 ÷ 28	50	15501018
Polyester braided sleeve 20 - grey	●	20 ÷ 30	50	15501020
Polyester braided sleeve 25 - grey	●	25 ÷ 38	50	15501025
Polyester braided sleeve 30 - grey	●	30 ÷ 49	50	15501030
Polyester braided sleeve 40 - grey	●	40 ÷ 60	50	15501040
Polyester braided sleeve 6 - black	●	6 ÷ 12	100	15502006
Polyester braided sleeve 8 - black	●	8 ÷ 15	100	15502008
Polyester braided sleeve 10 - black	●	10 ÷ 18	100	15502010
Polyester braided sleeve 12 - black	●	12 ÷ 22	50	15502012
Polyester braided sleeve 15 - black	●	15 ÷ 25	50	15502015
Polyester braided sleeve 18 - black	●	18 ÷ 28	50	15502018
Polyester braided sleeve 20 - black	●	20 ÷ 30	50	15502020
Polyester braided sleeve 25 - black	●	25 ÷ 38	50	15502025
Polyester braided sleeve 30 - black	●	30 ÷ 49	50	15502030
Polyester braided sleeve 40 - black	●	40 ÷ 60	50	15502040

BRAIDED SLEEVE POLYAMIDE



Description	Color	Ø bundle Min/Max (mm)	Pack (m)	Code
Polyamide braided sleeve 6 - grey	●	6 ÷ 9	100	15510006
Polyamide braided sleeve 8 - grey	●	8 ÷ 13	100	15510008
Polyamide braided sleeve 10 - grey	●	10 ÷ 15	100	15510010
Polyamide braided sleeve 12 - grey	●	12 ÷ 18	50	15510012
Polyamide braided sleeve 14 - grey	●	14 ÷ 20	50	15510014
Polyamide braided sleeve 16 - grey	●	16 ÷ 21	50	15510016
Polyamide braided sleeve 18 - grey	●	18 ÷ 22	50	15510018
Polyamide braided sleeve 20 - grey	●	20 ÷ 25	50	15510020
Polyamide braided sleeve 25 - grey	●	25 ÷ 28	50	15510025
Polyamide braided sleeve 30 - grey	●	30 ÷ 37	50	15510030
Polyamide braided sleeve 35 - grey	●	35 ÷ 45	50	15510035
Polyamide braided sleeve 40 - grey	●	40 ÷ 48	50	15510040

PVC Insulation Tape

Self-extinguishing PVC tape for mechanical and electrical applications



Features and benefits

- Self-extinguishing
- Good electrical insulation
- Suitable for applications at low temperature
- Good resistance to abrasion
- Available in different colours

Technical data

Material	Self-extinguishing PVC
Thickness	0,13/0,15/0,18 mm
Adhesion to the steel	2,5N/cm
Back adhesion	2,2N/cm
Breaking load	25N/cm (0,13 mm version) 27N/cm (0,15 mm version) 30N/cm (0,18 mm version)
Elongation at break	200% (0,13 mm version) 200% (0,15 mm version) 250% (0,18 mm version)
Dielectric strength	40kV/mm
Working temperature	-18°C ÷ +90°C
Flammability resistance	Self-extinguishing

Applications

- Electrical installation in residential and industrial building
- Electrical insulation
- Cable identification
- Cable protection

Approvals and certifications

CEI EN 60454-3-1

VDE approval: n. 40039640"



PVC INSULATION TAPE THICKNESS 0,13 MM

Description	Color	Length (m)	Width (mm)	Thickness (mm)	Pack (pcs.)	Code
PVC insulation tape 0,13 mm - 15 x 10	●	10	15	0,13	10	NI 20N
PVC insulation tape 0,13 mm - 15 x 10	○	10	15	0,13	10	NI 20BI
PVC insulation tape 0,13 mm - 15 x 10	●	10	15	0,13	10	NI 20BL
PVC insulation tape 0,13 mm - 15 x 10	●	10	15	0,13	10	NI 20GI
PVC insulation tape 0,13 mm - 15 x 10	●	10	15	0,13	10	NI 20GR
PVC insulation tape 0,13 mm - 15 x 10	●	10	15	0,13	10	NI 20R
PVC insulation tape 0,13 mm - 15 x 10	●	10	15	0,13	10	NI 20T
PVC insulation tape 0,13 mm - 15 x 10	●	10	15	0,13	10	NI 20V
PVC insulation tape 0,13 mm - 15 x 10	●	10	15	0,13	10	NI 20M
PVC insulation tape 0,13 mm - 19 x 25	●	25	19	0,13	10	NI 22N
PVC insulation tape 0,13 mm - 19 x 25	○	25	19	0,13	10	NI 22BI
PVC insulation tape 0,13 mm - 19 x 25	●	25	19	0,13	10	NI 22BL
PVC insulation tape 0,13 mm - 19 x 25	●	25	19	0,13	10	NI 22GI
PVC insulation tape 0,13 mm - 19 x 25	●	25	19	0,13	10	NI 22GR
PVC insulation tape 0,13 mm - 19 x 25	●	25	19	0,13	10	NI 22R
PVC insulation tape 0,13 mm - 19 x 25	●	25	19	0,13	10	NI 22T
PVC insulation tape 0,13 mm - 19 x 25	●	25	19	0,13	10	NI 22V
PVC insulation tape 0,13 mm - 19 x 25	●	25	19	0,13	10	NI 22M
PVC insulation tape 0,13 mm - 15 x 25	●	25	15	0,13	12	NI 21N
PVC insulation tape 0,13 mm - 19 x 10	●	10	19	0,13	10	NI 23N
PVC insulation tape 0,13 mm - 25 x 25	●	25	25	0,13	8	NI 24N
PVC insulation tape 0,13 mm - 38 x 25	●	25	38	0,13	5	NI 26N
PVC insulation tape 0,13 mm - 50 x 10	●	10	50	0,13	4	NI 27N
PVC insulation tape 0,13 mm - 50 x 25	●	25	50	0,13	4	NI 28N

PVC INSULATION TAPE THICKNESS 0,15 MM

Description	Color	Length (m)	Width (mm)	Thickness (mm)	Pack (pcs.)	Code
PVC insulation tape 0,15 mm - 15 x 10	●	10	15	0,15	10	NI 14N
PVC insulation tape 0,15 mm - 15 x 10	○	10	15	0,15	10	NI 14BI
PVC insulation tape 0,15 mm - 15 x 10	●	10	15	0,15	10	NI 14BL
PVC insulation tape 0,15 mm - 15 x 10	●	10	15	0,15	10	NI 14GR
PVC insulation tape 0,15 mm - 15 x 10	●	10	15	0,15	10	NI 14R
PVC insulation tape 0,15 mm - 15 x 10	●	10	15	0,15	10	NI 14T
PVC insulation tape 0,15 mm - 15 x 10	●	10	15	0,15	10	NI 14M
PVC insulation tape 0,15 mm - 19 x 25	●	25	19	0,15	10	NI 16N
PVC insulation tape 0,15 mm - 19 x 25	○	25	19	0,15	10	NI 16BI
PVC insulation tape 0,15 mm - 19 x 25	●	25	19	0,15	10	NI 16BL
PVC insulation tape 0,15 mm - 19 x 25	●	25	19	0,15	10	NI 16GR
PVC insulation tape 0,15 mm - 19 x 25	●	25	19	0,15	10	NI 16R
PVC insulation tape 0,15 mm - 19 x 25	●	25	19	0,15	10	NI 16T
PVC insulation tape 0,15 mm - 19 x 25	●	25	19	0,15	10	NI 16M
PVC insulation tape 0,15 mm - 25 x 25	●	25	25	0,15	8	NI 18N
PVC insulation tape 0,15 mm - 25 x 25	○	25	25	0,15	8	NI 18BI

PVC INSULATION TAPE THICKNESS 0,18 MM

Description	Color	Length (m)	Width (mm)	Thickness (mm)	Pack (pcs.)	Code
PVC insulation tape 0,18 mm - 19 x 20	●	20	19	0,18	10	NI 06N

Self-amalgamating Tape

Self-amalgamating tape in EPR to achieve a good mechanical protection and ideal for waterproofing



Features and benefits

- Good electrical insulation
- Excellent mechanical protection
- Quick self-bonding
- Good resistance to water and ozone

Applications

- Insulation of cables and cable connections in residential and industrial
- Electrical installation

Technical data

Material	ethylene propylene rubber
Halogen	absent
Nominal thickness	0,75 mm
Sheet adhesion	4 N/cm
Breaking load	20 N/cm
Dielectric strength	35 kV/mm
Working temperature	-40°C ÷ +90°C
Flammability resistance	Self-extinguishing

Installation

Remove the protective film and stretch the tape to reduce the width. Wrap the section to cover by overlapping 50% of each subsequent layer. Join the end of the tape to the section covered. It is recommended to cover the connection with PVC adhesive tape.

SELF-AMALGAMATING INSULATION TAPE THICKNESS 0,75 MM



Description	Color	Width (mm)	Length (m)	Pack (pcs.)	Code
Self-amalgamation insulating tape	●	19	10	1	NI 69A

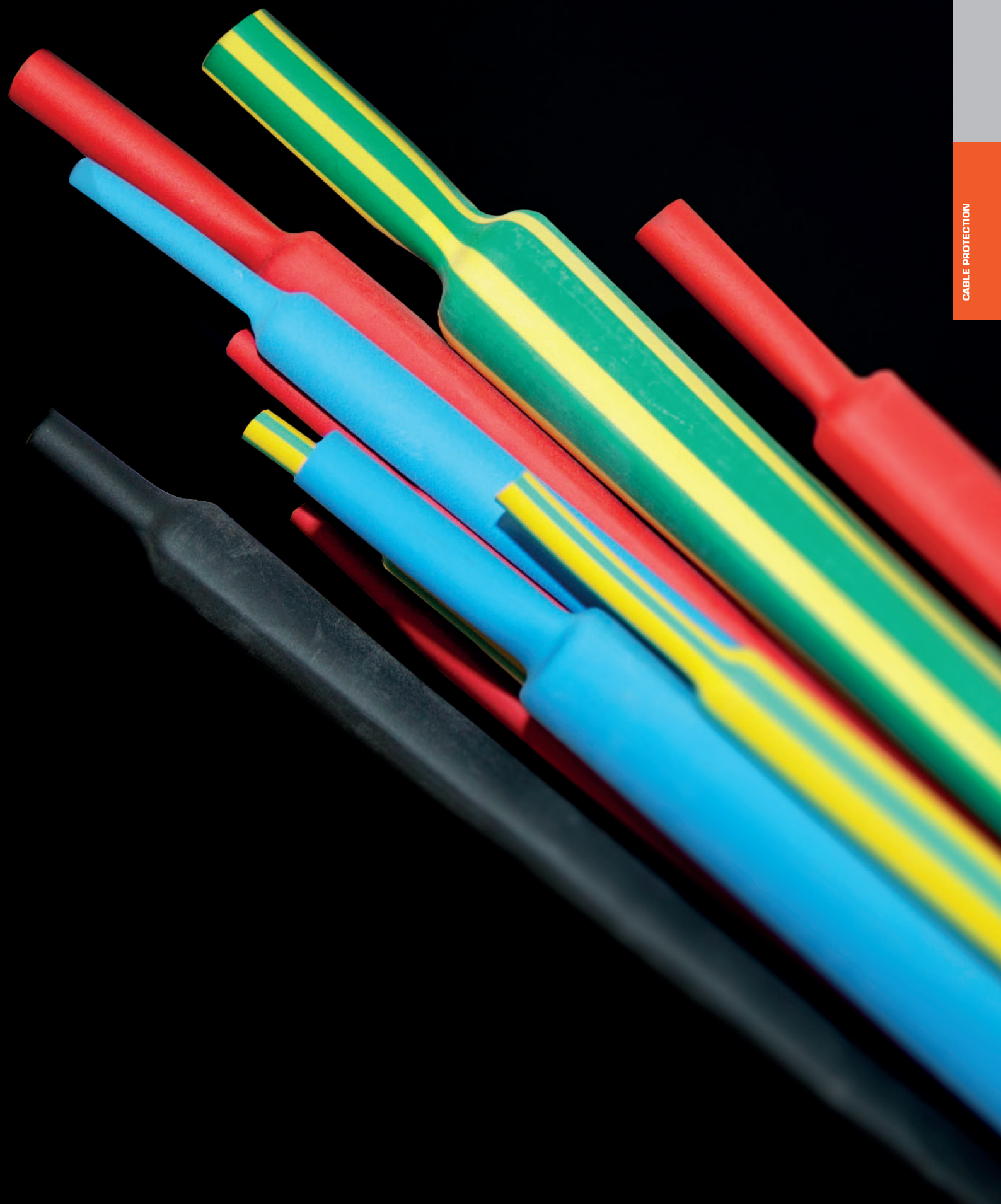

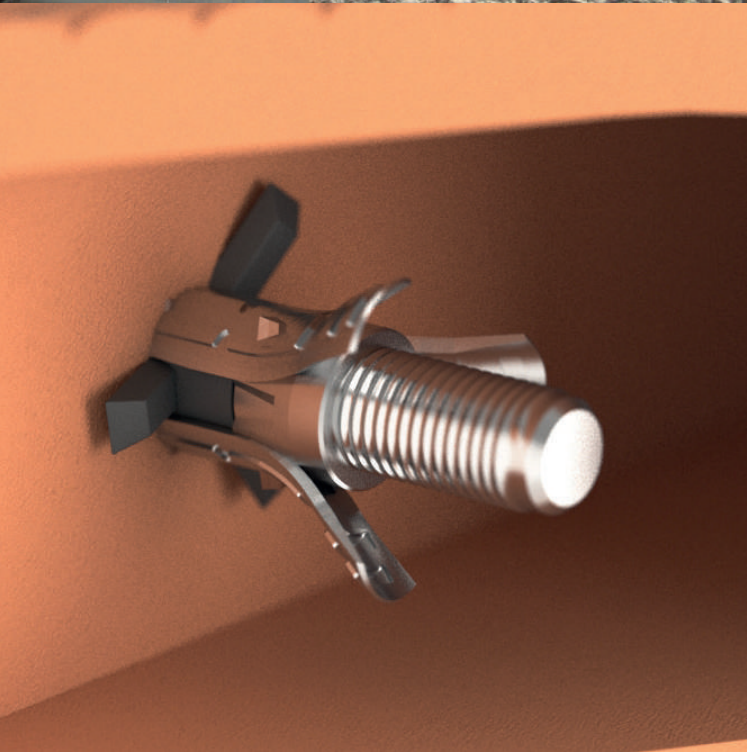
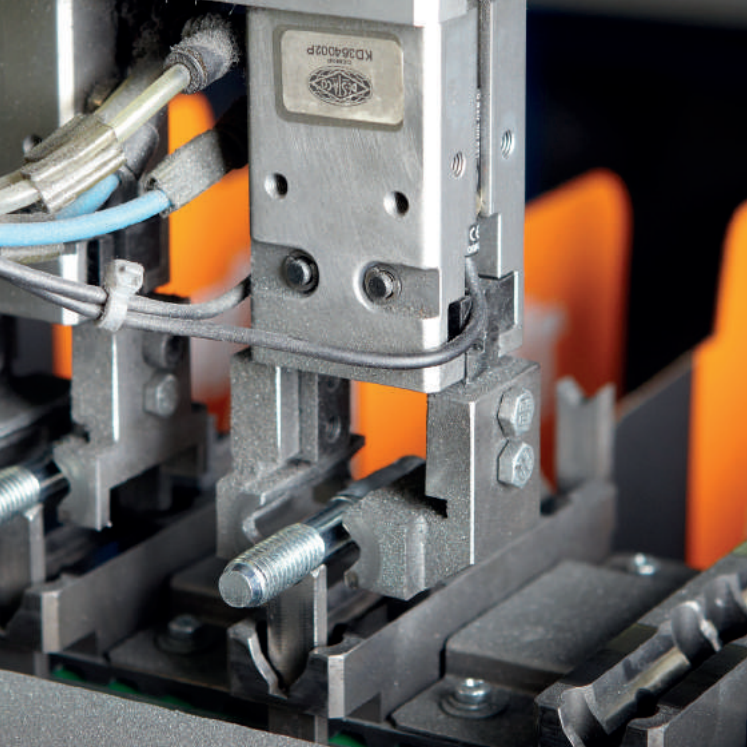



HEAVY-DUTY MECHANICAL ANCHORS

HEAVY-DUTY ANCHORS FOR CONCRETE

ETD III	94
T11	96
TRIDER	98
T101 PIOVRA	102
LE-LEX	104
EFPM	106
HPM	108
DYNABOLT PLUS	110
T21	112
EDC	113
ETHD	114
T51	115

Table reading guide

HEAVY-DUTY PUSH-THROUGH ANCHORS
(Example: EDT III, T11)

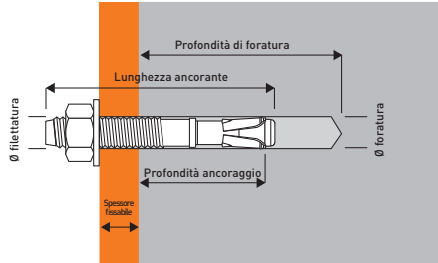

FRAME LIGHT-DUTY ANCHORS
(Example: T66, T88)

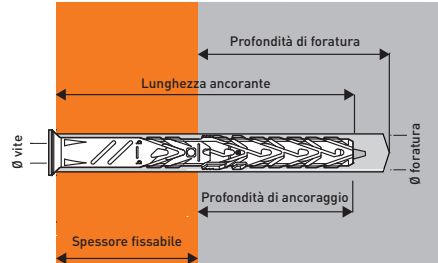

HEAVY-DUTY PUSH-THROUGH ANCHORS
(Example: LE-LEX, EFPM, HPM)

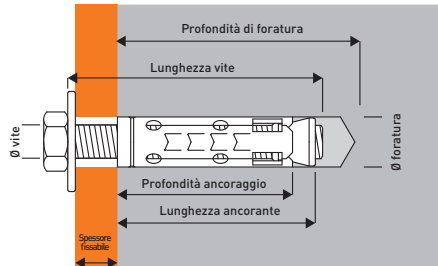

UNIVERSAL LIGHT-DUTY ANCHORS
(Example: BLUEFIX, T6, E-EB)

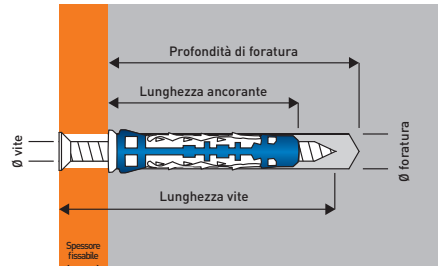

ANCHORS FOR INSULATION
EIS-D RANGE

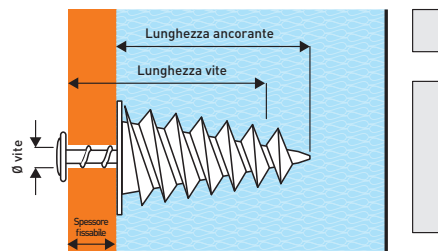

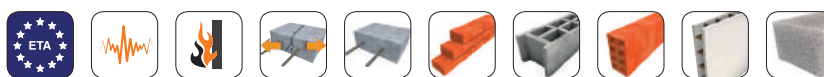

ETA	SEISMIC	FIRE RESISTANCE	CRACKED CONCRETE	NON-CRACKED CONCRETE	SOLID BRICK	HOLLOW BLOCK	HOLLOW BRICK	DRYWALL	AREATED CONCRETE	PAGE
-----	---------	-----------------	------------------	----------------------	-------------	--------------	--------------	---------	------------------	------

HEAVY-DUTY ANCHORS FOR CONCRETE										
ETD III		EAD 330232-00-0601 option 7		•	•					94
T11					•					96
TRIDER					•	•	•	•		100
T101 PIOVRA		EAD 330232-00-0601 option 7			•					102
LE-LEX					•	•				104
EFPM					•	•				106
HPM					•					108
T21					•	•				112
EDC						•				113
ETHD					•					114
T51					•	•				115

ETD III

Heavy-duty wedge anchor in zinc coated steel, for structural application in non-cracked concrete

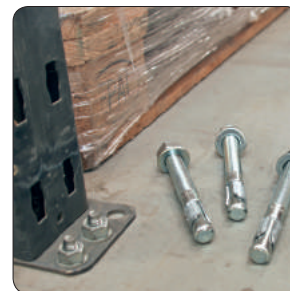

Base materials



Features and benefits

- ETA approved quality anchor for standard applications
- Long thread for embedment & fixture thickness flexibility
- Offers one of the highest loads of any ETA Option 7 approved anchor
- Low edge and spacing distance allowed
- Rapid expansion with improved clip design
- Letter marking engraved on the head (length checking on site)
- Fast installation and tightening with few turns
- Premium white-blue electrolytic zinc-plating for high corrosion resistance

Applications

- Support rails and brackets in HVAC and electrical installations
- Warehouse racks and storage systems
- Plumbing appliances
- Safety barriers
- Road signs
- Machine tools, conveyors
- Metal joinery
- Automated systems

Installation

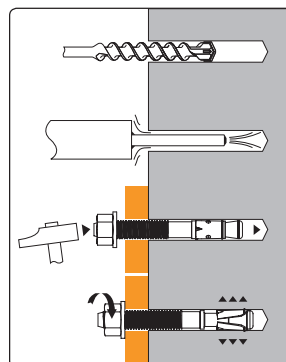

Approvals and certifications



ETA-13/0734
EAD 330232-00-0601
Option 7



Fire resistance
R90

Technical data

Anchor material white-blue electrolytic zinc plated steel

Ø thread	Application conditions in mm		Recommended tensile loads - Nrec in kN (1kN ~ 100 Kg)
	Ø drilling	Max. embedment depth	Non-cracked concrete C20/25
M8	8	40	3,57
M10	10	50	6,07
M12	12	65	8,50
M16	16	80	12,57
M20	20	100	24,05

Indicative recommended loads for single anchor. Consult the technical documentation for the correct fixing sizing

ETD III ZINC PLATED STEEL PRE-ASSEMBLED WITH NUT AND WASHER



Description	Ø thread (mm)	Anchor length (mm)	Ø drilling (mm)	Min. drilling depth (mm)	Min. embedment depth (mm)	Max. fixing thickness (mm)	Pack (pcs.)	Code
ETD III 8x55/5	M8	55	8	50	30	5	100	060010
ETD III 8x70/20-10	M8	70	8	50	30	20	100	060011
ETD III 8x90/40-30	M8	90	8	50	30	40	50	060012
ETD III 8x130/80-70	M8	130	8	50	30	80	50	060013
ETD III 8x160/110-100	M8	160	8	50	30	110	50	060014
ETD III 10x65/5	M10	65	10	60	40	5	50	060015
ETD III 10x75/15-5	M10	75	10	60	40	15	50	060016
ETD III 10x95/36-26	M10	95	10	60	40	36	50	060017
ETD III 10x125/65-55	M10	125	10	60	40	65	25	060018
ETD III 10x140/80-70	M10	140	10	60	40	80	25	060019
ETD III 12x80/5	M12	80	12	75	50	5	25	060020
ETD III 12x100/25-10	M12	100	12	75	50	25	25	060021
ETD III 12x115/40-25	M12	115	12	75	50	40	25	060022
ETD III 12x140/65-50	M12	140	12	75	50	65	25	060023
ETD III 12x160/85-70	M12	160	12	75	50	85	20	060161
ETD III 12x180/105-90	M12	180	12	75	50	105	20	060162
ETD III 12x220/145-130	M12	220	12	75	50	145	20	060026
ETD III 16x100/5	M16	100	16	95	65	5	20	060027
ETD III 16x125/30-15	M16	125	16	95	65	30	20	060028
ETD III 16x150/55-40	M16	150	16	95	65	55	10	060029
ETD III 16x170/75-60	M16	170	16	95	65	75	10	060030
ETD III 20x165/50-25	M20	165	20	110	75	50	10	060031
ETD III 20x220/105-80	M20	220	20	100	75	105	10	060032

T11

Wedge anchor in zinc coated steel, for non-cracked concrete



Base materials



Features and benefits

- High load capacity through bolt
- Long thread for embedment & fixture thickness flexibility
Ideal for medium duty applications
- Expansion clamp with special geometry in galvanized steel

Applications

- Support rails and brackets in HVAC and electrical installations
- Machine tools, conveyors
- Automated systems
- Plumbing appliances
- Fencing, gates

Installation

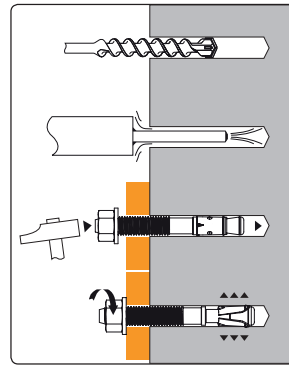

Technical data

Anchor material: electrolytic zinc plated steel

Ø thread	Application conditions in mm		Recommended tensile loads - Nrec in kN (1kN ~ 100 Kg)	
	Ø drilling	Max. embedment depth	Non-cracked concrete C20/25	
M6	6	40	3,00	
M8	8	48	4,70	
M10	10	55	6,30	
M12	12	65	9,90	
M14	14	75	11,90	
M16	16	84	13,80	

Indicative recommended loads for single anchor. Consult the technical documentation for the correct fixing sizing

T11

ZINC PLATED STEEL PRE-ASSEMBLED WITH NUT AND WASHER



Description	Ø thread (mm)	Anchor length (mm)	Ø drilling (mm)	Drilling depth (mm)	Min. embedment depth (mm)	Max. fixing thickness (mm)	Pack (pcs.)	Code
T11 6x55	M6	55	6	55	40	2	100	8716301
T11 6x65	M6	65	6	55	40	7	100	8716325
T11 6x85	M6	85	6	55	40	27	100	8716303
T11 6x100	M6	100	6	55	40	42	100	8716326
T11 8x53	M8	53	8	65	48	5	100	8716304
T11 8x65	M8	65	8	65	48	5	100	8716305
T11 8x75	M8	75	8	65	48	5	100	8716328
T11 8x90	M8	90	8	65	48	20	100	8716306
T11 8x120	M8	120	8	65	48	50	50	8716329
T11 10x65	M10	65	10	75	55	5	50	8716330
T11 10x75	M10	75	10	75	55	5	50	8716308
T11 10x95	M10	95	10	75	55	15	50	8716309
T11 10x120	M10	120	10	75	55	40	25	8716310
T11 10x140	M10	140	10	75	55	60	25	8716311
T11 10x160	M10	160	10	75	55	80	25	8716331
T11 12x75	M12	75	12	85	65	5	25	8716314
T11 12x110	M12	110	12	85	65	18	25	8716315
T11 12x140	M12	140	12	85	65	48	25	8716316
T11 12x160	M12	160	12	85	65	68	20	8716333
T11 12x180	M12	180	12	85	65	88	20	8716334
T11 14x100	M14	100	14	100	75	5	20	8716318
T11 14x120	M14	120	14	100	75	12	20	8716319
T11 14x160	M14	160	14	100	75	52	20	8716320
T11 16x110	M16	110	16	110	84	5	20	8716336
T11 16x125	M16	125	16	110	84	5	20	8716322
T11 16x145	M16	145	16	110	84	25	20	8716323
T11 16x175	M16	175	16	110	84	53	20	8716324
T11 16x220	M16	220	16	110	84	98	15	8716337

TRIDER

SMART
MECHANICAL
TRANSFORMATION

MEDIUM DUTY ANCHORING IS NO LONGER
JUST A MATTER OF CHEMISTRY



E ELEMATIC

MECHANICAL, IMMEDIATE, WORKS ON ALL MATERIALS

HIGH RESISTANCE SCREWS

Class 8.8 galvanized screws:
the highest resistance
to shear efforts.

EASY INSTALLATION

Anti-rotation polymer fins:
they adapt to the various materials by
blocking the rotation during screwing.

UNIVERSAL FLEXIBILITY

Flexible polymer body:
expands, flexes, knots, depending
on the material structure for great
performances on all materials

APPLICATION SAFETY

Cellulose dust protection:
protects the metric thread and ensures
a simple installation.

SECURE INSTALLATION

Positioning lip:
Prevents anchor slipping inside
hollow base materials

CONTROLLED EXPANSION

Steel expansion body:
expands effectively in three directions,
it does not damage the internal
sections of hollow base materials.

RELIABILITY AND VERSATILITY

Metal cone with metric thread:
completely integrated into the
expansion structure, it does not rotate
and fits different fixing accessories.



EASY AND FAST

- Reduced hole diameter; no specific tool
- Instantly loadable
- Ideal for professional installations



FOR ALL MATERIALS

- It can be used on solid or hollow base materials
- For installations with reduced distances between holes and from the edges
- Metallic, for medium and heavy-duty installations

TRIDER

Bi-material, universal, heavy-duty sleeved anchor for concrete, solid and hollow masonry structures

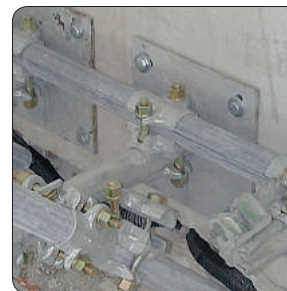

Base materials



Features and benefits

- Unique and exclusive multi-material performance
- Optimized expansion both in solid or hollow base materials
- Matches bonded anchor performance in hollow blocks
- Dual complementary expansion sleeves in steel and high strength polymer
- 3 full expansion steel legs ensure high-load performance
- 3 polymer expansion legs provide immediate grip in the inside of hollow materials while subsequent soft steel legs soft expansion creates grip without cracking the base material
- Cone firmly latched to the sleeve to avoid loss
- Large plastic lip to avoid over-embedment
- Effective integrated anti-rotation fins
- Special collated dust cap to avoid thread jamming

Technical data

Anchor material	electrolytic zinc plated steel ≥7µ LTH, High resistance polymer, cellulose protection and high density polymer lip
Screw material	class 8.8 electrolytic zinc plated steel

Installation

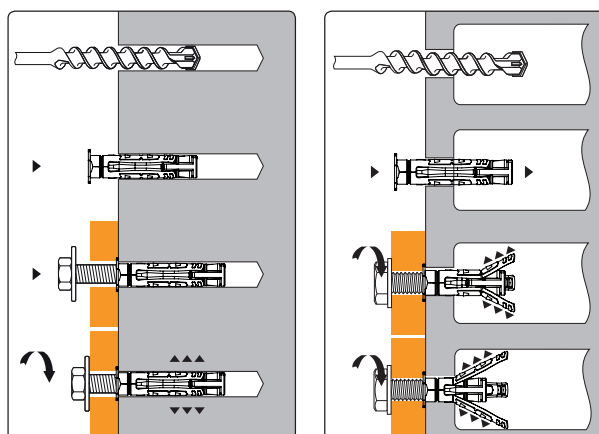

Applications

- Brackets for ducting, clamps, steel tracks, switchboards in electrical installations
- Support rails, clamps, hangers in HVAC
- Metal joinery
- Fencing, gates, handrails
- Industrial doors
- Facade frameworks
- Plumbing appliances
- Signs
- Antennas

Ø screw	Application conditions in mm		Recommended tensile loads - N _{rec} in kN [1kN ~ 100 Kg]	
	Ø drilling	Min. drilling depth	Non-cracked concrete C20/25	Concrete hollow block unrendered
TRIDER/ B 5	8	60	1,25	0,50
TRIDER/ B 6	10	65	1,85	0,70
TRIDER/ B 8	12	70	2,30	0,80
TRIDER/ B 10	15	85	4,45	0,90

Indicative recommended loads for single anchor. Consult the technical documentation for the correct fixing sizing

TRIDER

SLEEVE, ZINC PLATED SLEEVE AND POLYMER



Description	Ø thread (mm)	Anchor length (mm)	Ø drilling (mm)	Drilling depth (mm)	Min. embedment depth* (mm)	Pack (pcs.)	Code
TRIDER 5	M5	49	8	60	40	100	569550
TRIDER 6	M6	55	10	65	43	100	569551
TRIDER 8	M8	58	12	70	46	100	569552
TRIDER 10	M10	73	15	85	57	50	569553

* Lay on concrete and compact materials

TRIDER/B

ASSEMBLED WITH ZINC HEX HEAD SCREW CL. 8.8



Description	Ø thread (mm)	Anchor length (mm)	Ø drilling (mm)	Drilling depth (mm)	Min. embedment depth* (mm)	Screw: ø x length (mm)	Max. fixing thickness (mm)	Pack (pcs.)	Code
TRIDER 5	M5	49	8	60	40	M5x 60	10	50	569555
TRIDER 6	M6	55	10	65	43	M6x65	10	50	569556
TRIDER 8	M8	58	12	70	46	M8x70	10	50	569557
TRIDER 10	M10	73	15	85	57	M10x90	15	25	569558
PRO-PACK TRIDER 6*	M6	55	10	65	43	M6x65	10	16	569571
PRO-PACK TRIDER 8*	M8	58	12	70	46	M8x70	10	16	569572

* Lay on concrete and compact materials

**Distributor minimum purchasing quantity - 8 Pro-Pack (128 pcs)

T101 PIOVRA

Heavy-duty large expansion shield anchor, in zinc coated steel, for non-cracked concrete



Base materials



Features and benefits

- ETA Option 7 approved for non-cracked concrete
- 4 full expansion legs for better load distribution
- Exclusive anchoring fins, designed for superior grip and low displacement
- Superior performances compared to the traditional shield anchors
- Special Lanthane-F finishing allows higher corrosion resistance
- Internal collar for better screw guidance
- Available either with or without screw and with metric accessories

Applications

- Support rails and brackets in HVAC and electrical installations
- Metal joinery Structures, profiles and guides
- Shelving
- Tie rods, ropes and chains
- Hand rails, fencing, gates
- Aerials

Installation

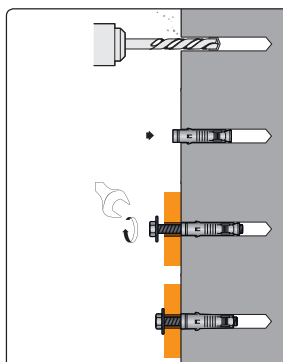

Approvals and certifications



ETA 11/0423
EAD 330232-00-0601
Option 7

Technical data

Anchor material electrolytic zinc plated steel

Ø	Application conditions in mm		Recommended tensile loads - Nrec in kN (1kN ~ 100 Kg)	Access breakage in KN (1kN ~ 100 Kg)
	Ø drilling	Min. drilling depth		
M6	12	41	5,40	0,30
M8	14	46	6,60	0,70
M10	16	56	10,20	1,10
M12	20	64	14,30	1,70

Indicative recommended loads for single anchor. Consult the technical documentation for the correct fixing sizing
* Accessories range representative value: request the technical data sheet for detailed data.

T101 PIOVRA SLEEVE



Description	Ø thread (mm)	Ø drilling (mm)	Drilling depth (mm)	Anchor length (mm)	Min. screw length (mm)*	Pack (pcs.)	Code
T101 PIOVRA 6	M6	12	60	48	55	50	8716000
T101 PIOVRA 8	M8	14	65	55	60	50	8716001
T101 PIOVRA 10	M10	16	75	65	70	25	8716002
T101 PIOVRA 12	M12	20	85	77	85	25	8716003

* screw not supplied

T101 PIOVRA/B HEX HEAD SCREW



Description	Ø thread (mm)	Ø drilling (mm)	Drilling depth (mm)	Anchor length (mm)	Max. fixing thickness (mm)	Pack (pcs.)	Code
T101 PIOVRA/B 6	M6	12	60	48	10	50	8716010
T101 PIOVRA/B 8	M8	14	65	55	15	50	8716011
T101 PIOVRA/B 10	M10	16	75	65	15	25	8716012
T101 PIOVRA/B 12	M12	20	85	77	20	20	8716013

T101 PIOVRA/OC CLOSED EYE HOOK



Description	Ø thread (mm)	Ø drilling (mm)	Drilling depth (mm)	Anchor length (mm)	Pack (pcs.)	Code
T101 PIOVRA/OC 6	M6	12	60	48	50	8716030
T101 PIOVRA/OC 8	M8	14	65	55	25	8716031
T101 PIOVRA/OC 10	M10	16	75	65	15	8716032

LE-LEX

Heavy-duty large expansion shield anchor, in zinc coated steel, for non-cracked concrete and solid base materials



Base materials



Features and benefits

- 4 full expansion legs for better grip
- Low spacing and edge distance installation
- Anti-rotation fins ensure easy setting
- Cone linked to the body to avoid cone loss
Flexible fixture thickness
- Available either with or without screw and with metric accessories
- Stainless steel variant available

Applications

- Support rails and brackets in HVAC and electrical installations
- Metal joinery
- Structures, profiles and guides
- Shelving
- Tie rods, ropes and chains
- Hand rails, fencing, gates
- Aerials

Installation

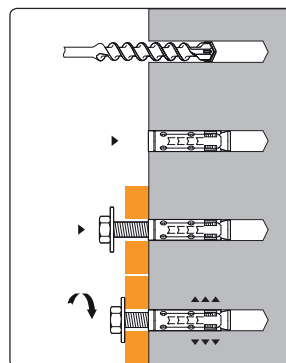

Technical data

Anchor material	electrolytic zinc plated steel (LE version)
	stainless steel INOX A2 - AISI 304 (LEX version)

Ø	Application conditions in mm		Recommended tensile loads - Nrec in kN (1kN ~ 100 Kg)	Access breakage in KN (1kN ~ 100 Kg)*
	Ø drilling	Max. embedment depth		
M6	10	35	2,50	0,30
M8	12	40	3,00	0,70
M10	15	51	4,20	1,10
M12	18	63	6,60	1,70

Indicative recommended loads for single anchor. Consult the technical documentation for the correct fixing sizing
* Accessories range representative value; request the technical data sheet for detailed data.

LE-LEX SLEEVE



Description	Ø thread (mm)	Anchor length (mm)	Ø drilling (mm)	Drilling depth (mm)	Min. embedment depth (mm)	Pack (pcs.)	Code
LE 6	M6	45	10	55	35	100	8717001
LE 8	M8	50	12	60	40	100	8717002
LE 10	M10	60	15	75	51	50	8717003
LE 12	M12	74	18	90	63	25	8717004
LEX 6 A2-AISI 304	M6	45	10	55	35	100	8717011
LEX 8 A2-AISI 304	M8	50	12	60	40	100	8717012
LEX 10 A2-AISI 304	M10	60	15	75	51	50	8717013
LEX 12 A2-AISI 304	M12	74	18	90	63	25	8717014

LE/B - LEX/B HEX HEAD SCREW



Description	Ø thread (mm)	Anchor length (mm)	Ø drilling (mm)	Drilling depth (mm)	Min. embedment depth (mm)	Screw: ø x length	Max. fixing thickness (mm)	Pack (pcs.)	Code
LE/B 6	M6	45	10	55	35	M6x55	5	50	8717101
LE/B 8	M8	50	12	60	40	M8x60	10	50	8717102
LE/B 10	M10	60	15	75	51	M10x80	20	25	8717103
LE/B 12	M12	74	18	90	63	M12x90	25	20	8717104
LE/B 6 blister	M6	45	10	55	35	M6x55	10	4	565469
LE/B 8 blister	M8	50	12	60	40	M8x60	25	4	565470
LE/B 10 blister	M10	60	15	75	51	M10x80	45	2	566010
LEX/B 6 A2-AISI 304	M6	45	10	55	35	M6x55	5	50	8717021
LEX/B 8 A2-AISI 304	M8	50	12	60	40	M8x60	10	50	8717022
LEX/B 10 A2-AISI 304	M10	60	15	75	51	M10x80	20	25	8717023
LEX/B 12 A2-AISI 304	M12	74	18	90	63	M12x90	25	20	8717024

LE/BP HEX HEAD SCREW AND SPACER



Description	Ø thread (mm)	Anchor length (mm)	Ø drilling (mm)	Drilling depth (mm)	Min. embedment depth (mm)	Screw: ø x length	Max. fixing thickness (mm)	Pack (pcs.)	Code
LE/BP 6	M6	70	10	80	35	M6x70	25	50	8717106
LE/BP 8	M8	75	12	85	40	M8x80	25	25	8717107
LE/BP 10	M10	85	15	100	51	M10x90	25	25	8717108
LE/BP 12	M12	105	18	120	63	M12x110	30	20	8717109

LE/G ZINC PLATED HOOK



Description	Ø thread (mm)	Anchor length (mm)	Ø drilling (mm)	Drilling depth (mm)	Hook opening (mm)	Pack (pcs.)	Code
LE/G 6	M6	45	10	55	7,5	50	8717301
LE/G 8	M8	50	12	60	9,0	25	8717302
LE/G 10	M10	60	15	75	12	15	8717303
LE/G 12	M12	74	18	90	15	10	8717304
LE/G 6 blister	M6	45	10	55	7,5	2	565471
LE/G 8 blister	M8	50	12	60	9,0	2	565472

LE/OC ZINC PLATED EYE HOOK



Description	Ø thread (mm)	Anchor length (mm)	Ø drilling (mm)	Drilling depth (mm)	Ø eyehook (mm)	Pack (pcs.)	Code
LE/OC 6	M6	45	10	55	10	50	8717401
LE/OC 8	M8	50	12	60	11	25	8717402
LE/OC 10	M10	60	15	75	14,5	20	8717403
LE/OC 12	M12	74	18	90	17	10	8717404
LE/OC 6 blister	M6	45	10	55	10	2	565473
LE/OC 8 blister	M8	50	12	60	11	2	565474

LE/R ANTI-TAMPERING HEX HEAD SCREW



Description	Ø thread (mm)	Anchor length (mm)	Ø drilling (mm)	Drilling depth (mm)	Screw: ø x length	Max. fixing thickness (mm)	Pack (pcs.)	Code
LE/R 8x75	M8	75	12	85	M8x75	20	25	8717507

EFPM

Heavy-duty large expansion shield anchor, in zinc coated steel, for non-cracked concrete and solid base materials



Base materials



Features and benefits

- Heavy-duty anchor
- Anti-rotation fins ensure easy setting
- Dust cap prevents screw jamming
- Available either with or without hex head bolt and with metric accessories

Applications

- Support rails and brackets in HVAC and electrical installations
- Structures, profiles and guides
- Tie rods, ropes and chains
- Hand rails, fencing, gates
- Aerials

Installation

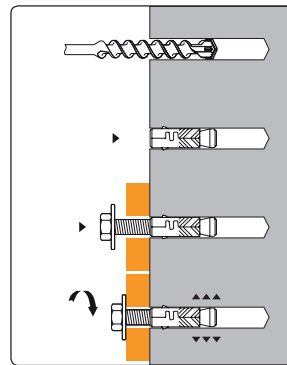

Technical data

Anchor material: electrolytic zinc plated steel

Ø	Application conditions in mm		Recommended tensile loads - Nrec in kN (1kN ~ 100 Kg)	Access breakage in KN (1kN ~ 100 Kg)*
	Ø drilling	Max. embedment depth		
M6	12	40	3,30	0,30
M8	14	44	4,30	0,70
M10	16	57	5,40	1,10
M12	20	65	6,70	1,70
M16	24	73	7,70	-

Indicative recommended loads for single anchor. Consult the technical documentation for the correct fixing sizing
 * Accessories range representative value: request the technical data sheet for detailed data.

EFPM SLEEVE



Description	Ø thread (mm)	Anchor length (mm)	Ø drilling (mm)	Drilling depth (mm)	Min. embedment depth (mm)	Pack (pcs.)	Code
EFPM 6	M6	45	12	55	40	50	8715000
EFPM 8	M8	50	14	60	44	50	8715001
EFPM 10	M10	65	16	75	57	25	8715002
EFPM 12	M12	75	20	90	67	25	8715003

EFPM/B HEX HEAD SCREW



Description	Ø thread (mm)	Anchor length (mm)	Ø drilling (mm)	Drilling depth (mm)	Min. embedment depth (mm)	Screw: ø x length	Max. fixing thickness (mm)	Pack (pcs.)	Code
EFPM/B 6	M6	45	12	55	40	M6x55	10	50	8715100
EFPM/B 8	M8	50	14	60	44	M8x60	10	50	8715101
EFPM/B 10	M10	65	16	75	57	M10x80	15	25	8715102
EFPM/B 12	M12	75	20	90	67	M12x90	20	20	8715103
EFPM/B 16	1M6	90	24	105	73	M16x100	20	10	8715104
EFPM/B 6 blister	M6	45	12	55	40	M6x55	10	2	565466
EFPM/B 8 blister	M8	50	14	60	44	M8x60	10	2	565467
EFPM/B 10 blister	M10	65	16	75	57	M10x80	15	2	565468

EFPM/G ZINC PLATED HOOK



Description	Ø thread (mm)	Anchor length (mm)	Ø drilling (mm)	Drilling depth (mm)	Min. embedment depth (mm)	Hook opening (mm)	Pack (pcs.)	Code
EFPM/G 6	M6	45	12	55	40	7,50	50	8715300
EFPM/G 8	M8	50	14	60	44	9	25	8715301
EFPM/G 10	M10	65	16	75	57	12	15	8715302
EFPM/G 8 blister	M8	50	14	60	44	9	2	566012

EFPM/OC CLOSED EYE HOOK



Description	Ø thread (mm)	Anchor length (mm)	Ø drilling (mm)	Drilling depth (mm)	Min. embedment depth (mm)	Ø eyehook (mm)	Pack (pcs.)	Code
EFPM/OC 6	M6	45	12	55	40	10	50	8715200
EFPM/OC 8	M8	50	14	60	44	11	25	8715201
EFPM/OC 10	M10	65	16	75	57	14,5	20	8715202
EFPM/OC 12	M12	75	20	90	67	17	10	8715203
EFPM/OC 8 blister	M8	50	14	60	44	11	2	566014

HPM

Large expansion shield anchor, in zinc-aluminium alloy, for solid base materials and non-cracked concrete



Base materials



Features and benefits

- 4 full expansion legs for better load distribution
- Anti-rotation fins ensure easy setting
- Cone linked to the body to avoid cone loss
- Roughened legs surface for the best grip
- Available either with or without hex head bolt

Applications

- Support rails and brackets in HVAC and electrical installations
- Structures profiles and guides
- Hand rails, fencing, gates
- Aerials

Installation

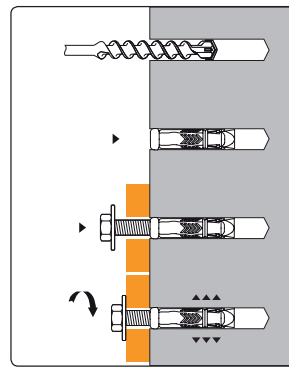

Technical data

Anchor material zinc-aluminium alloy and electrolytic zinc plated steel

Ø	Application conditions in mm		Recommended tensile loads - Nrec in kN (1kN ~ 100 Kg)	Access breakage in KN (1kN ~ 100 Kg)*
	Ø drilling	Max. embedment depth		
M6	12	40	2,50	0,30
M8	14	45	3,10	0,70
M10	16	50	5,00	1,10

Indicative recommended loads for single anchor. Consult the technical documentation for the correct fixing sizing
 * Accessories range representative value: request the technical data sheet for detailed data.

HPM SLEEVE



Description	Ø thread (mm)	Anchor length (mm)	Ø drilling (mm)	Drilling depth (mm)	Min. embedment depth (mm)	Pack (pcs.)	Code
HPM 6	M6	45	12	55	40	50	8713000
HPM 8	M8	52	14	60	45	50	8713001
HPM 10	M10	60	16	60	50	25	8713002

HPM/B ZINC HEX HEAD SCREW



Description	Ø thread (mm)	Anchor length (mm)	Ø drilling (mm)	Drilling depth (mm)	Min. embedment depth (mm)	Screw: ø x length	Max. fixing thickness (mm)	Pack (pcs.)	Code
HPM/B 6	M6	45	12	55	40	M6x55	10	50	8713010
HPM/B 8	M8	52	14	60	45	M8x60	10	50	8713011
HPM/B 10	M10	60	16	60	50	M10x80	15	25	8713012

DYNABOLT PLUS

Through fixing sleeved anchor, in zinc coated steel, for non-cracked concrete and solid base materials

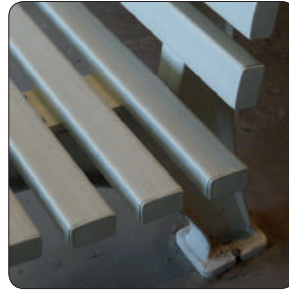

Base materials



Features and benefits

- Deformable body structure for a perfect adherence of the object to fix to the base material
- Quick and easy installation thanks to the pass-through design

Applications

- Support rails and brackets in HVAC and electrical installations
- Plumbing appliances
- Signs
- Metal joinery
- Air ducts
- Antennas

Installation

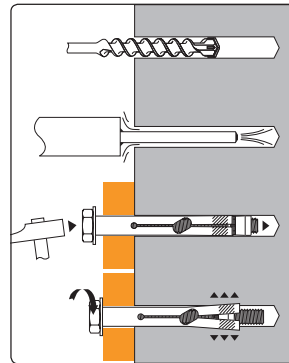

Technical data

Anchor material: electrolytic zinc plated steel

Ø	Application conditions in mm		Recommended tensile loads - Nrec in kN (1kN ~ 100 Kg)	
	Ø drilling	Max. embedment depth	Non-cracked concrete C20/25	Solid brick
M6	8	30	1,93	2,20
M8	10	34	2,79	2,90
M10	12	44	3,36	5,30

Indicative recommended loads for single anchor. Consult the technical documentation for the correct fixing sizing

DYNABOLT PLUS/B HEX HEAD SCREW



Description	Ø thread (mm)	Anchor length (mm)	Ø drilling (mm) (mm)	Drilling depth (mm)	Min. embedment depth (mm)	Max. fixing thickness (mm)	Pack (pcs.)	Code
DYNABOLT/B 8x45	M6	45	8	45	26	8	100	050489
DYNABOLT/B 8x70	M6	70	8	45	30	30	50	050491
DYNABOLT/B 8x95	M6	95	8	45	30	56	50	050492
DYNABOLT/B 10x55	M8	55	10	50	28	8	50	050493
DYNABOLT/B 10x80	M8	80	10	50	34	35	50	050494
DYNABOLT/B 10x105	M8	105	10	50	34	62	25	050495
DYNABOLT/B 12x75	M10	75	12	65	44	18	25	050496
DYNABOLT/B 12x105	M10	105	12	65	44	46	20	050497

DYNABOLT PLUS/E COUNTERSUNK FLAT HEAD SCREW



Description	Ø thread (mm)	Anchor length (mm)	Ø drilling (mm) (mm)	Drilling depth (mm)	Min. embedment depth (mm)	Max. fixing thickness (mm)	Pack (pcs.)	Code
DYNABOLT/E M6x8x45	M6	45	8	40	40	10	100	8723091
DYNABOLT/E M6x8x65	M6	65	8	45	40	25	100	8723092
DYNABOLT/E M8x10x50	M8	50	10	45	45	10	50	8723093
DYNABOLT/E M8x10x70	M8	70	10	50	45	25	50	8723094
DYNABOLT/E M10x12x80	M10	80	12	60	55	25	50	8723096

T21

Through fixing sleeved anchor, in zinc coated steel, for non-cracked concrete and solid base materials



Installation

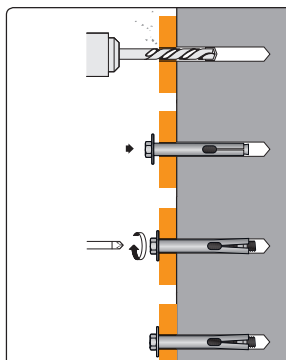

Base materials



Features and benefits

- Through bolt for wasy and fast setting, hexagonal head for aesthetic finishing
- Collapsing system to provide clamping of the fixture Hex head bolt cl. 8.8 and larger diameter washer

Technical data

Anchor material electrolytic zinc plated steel

Applications

- Support rails and brackets in HVAC and electrical installations
- Metal joinery

Ø	Application conditions in mm		Recommended tensile loads - Nrec in kN (1kN ~ 100 Kg)	
	Ø drilling	Max. embedment depth	Non-cracked concrete C20/25	
T21 8	8	30	1,64	
T21 10	10	35	2,34	
T21 12	12	40	2,60	
T21 14	14	40	3,00	
T21 16	16	42	4,34	

Indicative recommended loads for single anchor. Consult the technical documentation for the correct fixing sizing

T21 HEX HEAD SCREW



Description	Ø thread (mm)	Anchor length (mm)	Ø drilling (mm)	Drilling depth (mm)	Min. embedment depth (mm)	Max. fixing thickness (mm)	Pack (pcs.)	Code
T21 8x45	M6	45	8	40	30	5	100	8723050
T21 8x60	M6	60	8	40	30	20	100	8723051
T21 8x70	M6	80	8	40	30	30	100	8723052
T21 8x95	M6	95	8	40	30	55	100	8723053
T21 8x120	M6	120	8	40	30	80	25	8723063
T21 10x60	M8	60	10	45	35	10	50	8723054
T21 10x80	M8	80	10	45	35	30	50	8723056
T21 10x105	M8	105	10	45	35	55	25	8723057
T21 10x120	M8	120	10	45	35	70	25	8723064
T21 10x140	M8	140	10	45	35	90	25	8723065
T21 12x70	M10	70	12	50	40	10	25	8723058
T21 12x100	M10	100	12	50	40	35	25	8723059
T21 12x120	M10	120	12	50	40	55	25	8723066
T21 12x150	M10	150	12	50	40	85	20	8723067
T21 14x70	M10	70	14	50	40	15	25	8723068
T21 14x100	M10	100	14	50	40	45	25	8723060
T21 14x120	M10	120	14	50	40	65	25	8723069
T21 14x150	M10	150	14	50	40	95	25	8723070
T21 16x80	M12	80	16	52	42	20	25	8723061
T21 16x110	M12	110	16	52	42	50	20	8723062
T21 16x130	M12	130	16	52	42	70	15	8723071
T21 16x150	M12	150	16	52	42	90	15	8723072

EDC

Wedge anchor with cap nut, for concrete



Installation

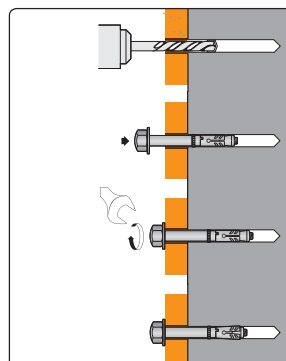

Base materials



Features and benefits

- Aesthetic and safe finishing
- Low drilling diameter and long anchoring depth
- Fast and easy setting
- Cold-formed expansion clip

Technical data

Anchor material: electrolytic zinc plated steel

Applications

- Street furniture
- Buffers, barriers
- Stairlifts
- Road signs

Ø	Application conditions in mm		Recommended tensile loads - Nrec in kN (1kN ~ 100 Kg)
	Ø drilling	Max. embedment depth	Non-cracked concrete C20/25
EDC 8	8	50	1,60
EDC 10	10	60	2,30
EDC 12	12	70	3,00
EDC 14	14	80	3,70
EDC 16	16	90	4,10

Indicative recommended loads for single anchor. Consult the technical documentation for the correct fixing sizing

EDC ZINC CUP NUT



Description	Anchor length (mm)	Ø drilling (mm)	Drilling depth (mm)	Min. embedment depth (mm)	Max. fixing thickness (mm)	Wrench (mm)	Pack (pcs.)	Code
EDC 8x70	70	8	70	50	15	13	50	8750001
EDC 8x85	85	8	70	50	30	13	50	8750002
EDC 10x85	85	10	80	60	15	17	50	8750003
EDC 10x120	120	10	80	60	50	17	50	8750004
EDC 12x100	100	12	90	70	15	19	50	8750005
EDC 12x135	135	12	90	70	50	19	50	8750006
EDC 14x115	115	14	100	80	20	22	25	8750007
EDC 14x145	145	14	100	80	50	22	25	8750008
EDC 16x130	130	16	110	90	20	24	25	8750009
EDC 16x150	150	16	110	90	40	24	25	8750010

ETHD

Inner thread flush anchor, in zinc coated steel, for non-cracked concrete



Base materials



Features and benefits

- Allows use of every type of metric threaded bolt or rod
- Short embedment depth avoiding rebar contact
- Flexible fixture thickness
- Allows fixture removal without damaging the anchor
- Reliable setting control using the related setting tool

Installation

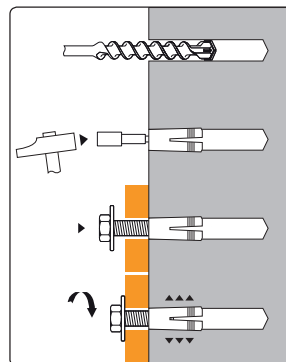

Applications

- Threaded rods suspensions
- Support rails and brackets in HVAC and electrical installations
- Benches, gazebo, garden furniture
- Hand rails, fencing, gates

Technical data

Anchor material: electrolytic zinc plated steel

Ø	Application conditions in mm		Recommended tensile loads - Nrec in kN (1kN ~ 100 Kg)	
	Ø drilling	Max. embedment depth	Non-cracked concrete C20/25	
M6	8	30	3,29	
M8	10	30	3,29	
M10	12	40	5,07	
M12	15	50	7,07	

Indicative recommended loads for single anchor. Consult the technical documentation for the correct fixing sizing

ETHD ZINC PLATED STEEL NO LIP



Description	Ø thread (mm)	Anchor length (mm)	Ø drilling (mm)	Drilling depth (mm)	Min. embedment depth (mm)	Expander code*	Expander dimension	Pack (pcs.)	Code
ETHD M6x30	M6	30	8	32	30	050922	M6x30	200	8724001
ETHD M8x30	M8	30	10	33	30	050923	M8x30	100	8724002
ETHD M10x40	M10	40	12	43	40	050924	M10x40	100	8724003
ETHD M12x50	M12	50	15	54	50	050925	M12x50	50	8724004

* Marking expander supplied separately - not included in the packs

T51

Internally threaded brass anchor, for solid base materials

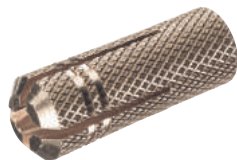

Base materials



Features and benefits

- 4-ways large expansion body, easy to use thanks to immediate expansion by screwing
- Wide expansion for the of the accessory or the screw, excellent grip thanks to the knurled surface that avoids rotation on light duty materials such as wood
- Conical expansion section that can fit crews, rod and accessories with metric thread

Installation

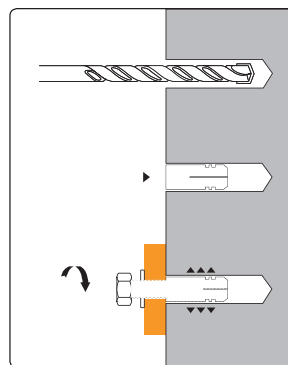

Applications

- Hangers for tubes, pipes for HVAC or electrical installations
- Handrails
- Industrial door frames

Technical data

Anchor material: brass

Ø thread	Application conditions in mm		Recommended tensile loads - Nrec in kN (1kN ~ 100 Kg)	
	Ø drilling		Non-cracked concrete C20/25	
M5	6,5		0,96	
M6	8		1,02	
M8	10		1,95	
M10	12		2,65	
M12	15		2,95	

* Indicative recommended loads for single anchor. Consult the technical documentation for the correct fixing sizing



Description	Ø thread (mm)	Anchor length (mm)	Ø drilling (mm)	Drilling depth (mm)	Min. screw length (mm)	Pack (pcs.)	Code
T51 M5	M5	21	6,5	30	25	200	8727002
T51 M6	M6	24	8	40	30	300	8727003
T51 M8	M8	29	10	45	35	200	8727004
T51 M10	M10	32	12	50	40	100	8727005
T51 M12	M12	40	15	60	45	50	8727006
T51 M6 blister	M6	24	8	40	30	8	565452
T51 M8 blister	M8	29	10	45	35	8	565453
T51/I M8 industrial	M8	29	10	45	35	2500	8727104
T51/I M10 industrial	M10	32	12	50	40	2000	8727105

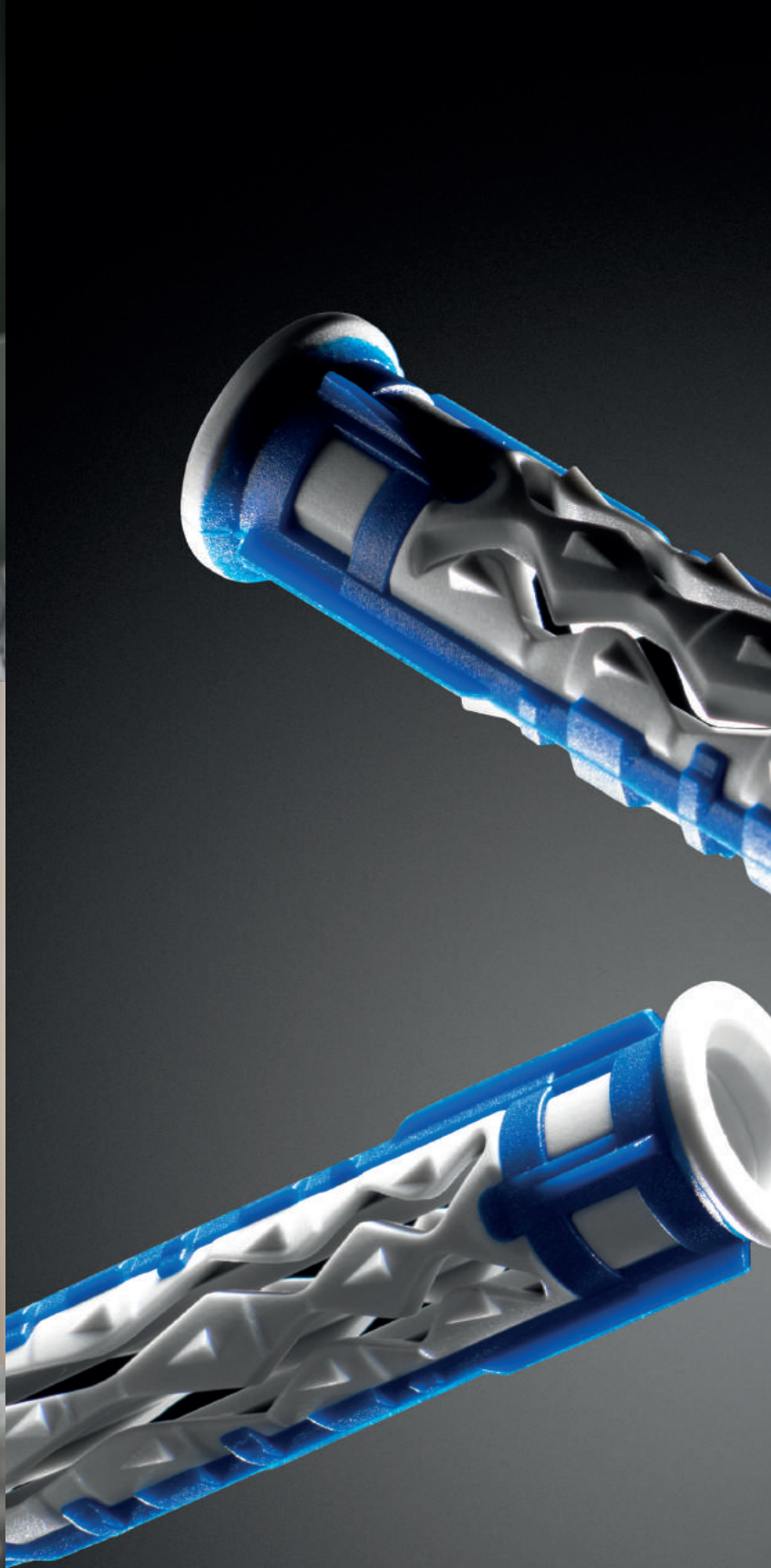

LIGHTWEIGHT AND SPECIAL MECHANICAL ANCHORS

FRAME MECHANICAL ANCHORS

T66	120
T88	122
APS	124
APR	127
ETFP	128

PUSH-THROUGH ANCHORS

JTX	129
UCX	130
HCX	132
ETCD	134

UNIVERSAL LIGHT-DUTY ANCHORS

BLUEFIX	136
T6	138
E/EB	140
T4	143
TPF-TPFC	144
ENP	146
T61	150
XTECH	152
EMS	153

PLASTERBOARD MECHANICAL ANCHORS

T-CLICK	154
DRIVE	155
DRIVA NYLON	156
MINI DRIVA	157

ANCHORS FOR HOLLOW BASE MATERIALS

ETPV ZENTECH	158
ETAF	159
ETR	161
ETNF	162

ANCHORS FOR INSULATION CLADDING

EIS-D	163
-------	-----

ANCHORS FOR ELECTRICAL INSTALLATIONS

ECLIP	165
CT-CLIP	166
ELEFIX	167
ECAV	168
S-CLIP	169
COLLARS M6	170

ANCHORS FOR PLUMBING

E/CL - CL/Z	171
EMB	172
EMC	172
EB/SB	172
ETS/V	173
ETS/L	173

MANUAL NAILING AND ACCESSORIES

IMPACT NAILS	174
EDS	175



		ETA	SEISMIC TEST	FIRE RESISTANCE	CONCRETE	SOLID BRICK	HOLLOW BLOCK	HOLLOW BRICK	DRYWALL	AREATED CONCRETE	INSULATION PANELS	PAGE
EXTENDED ANCHORS												
T66		based on ETAG 020	•	•	•	•	•	•		•		120
T88		based on ETAG 020	•	•	•	•	•	•		•		122
APS					•	•	•	•		•		124
APR					•	•						127
ETFP					•	•						128
PUSH-THROUGH ANCHORS												
JTX					•	•	•	•		•		129
UCX					•	•						130
HGX					•	•						132
ETCD					•	•						134
UNIVERSAL LIGHT-DUTY ANCHORS												
BLUEFIX			•		•	•	•	•	•	•		136
T6					•	•	•	•	•	•		138
E-EB					•	•	•	•				140
T4					•	•	•	•	•	•		143
TPF-TPFC					•	•	•	•	•	•		144
ENP					•	•	•	•				146
T61					•	•						150
XTECH							•	•	•			152
EMS					•	•	•	•				153
ANCHORS FOR PLASTERBOARD AND HOLLOW BASE MATERIALS												
T-CLICK									•	•		154
DRIVA									•	•		155
DRIVA NYLON									•	•		156
MINI DRIVA									•	•		157
ETPV							•	•	•			158
ETAF							•	•	•			159
ETR							•	•	•			161
ETNF							•	•	•			162
ANCHORS FOR INSULATION CLADDING												
EIS-D											•	163



ETA	SEISMIC	FIRE RESISTANCE	STEEL	CONCRETE	SOLID BRICK	HOLLOW BLOCK	HOLLOW BRICK	LIGHTWEIGHT CONCRETE	AREATED CONCRETE	WOOD	PAG.
-----	---------	-----------------	-------	----------	-------------	--------------	--------------	----------------------	------------------	------	------

ANCHORS FOR ELECTRICAL INSTALLATIONS

ECLIP		According to the fixing system used									165
CT-CLIP		According to the fixing system used									166
ELEFIX		According to the fixing system used									167
ECAV		According to the fixing system used									168
S-CLIP		According to the fixing system used									169
COLLARS MG		According to the fixing system used									170

ANCHORS FOR PLUMBING

		ETA	SEISMIC	FIRE RESISTANCE	STEEL	CONCRETE	SOLID BRICK	HOLLOW BLOCK	HOLLOW BRICK	LIGHTWEIGHT CONCRETE	AREATED CONCRETE	WOOD	PAG.
E/CL						•	•	•	•				171
EMB						•	•	•	•				172
EMC						•	•	•	•				172
EB/SB						•	•	•	•				172
ETS/V						•	•	•	•				173
ETS/L						•	•	•	•				173

MANUAL NAILING AND ACCESSORIES

EDS											175
------------	--	--	--	--	--	--	--	--	--	--	-----

T66

Extremely versatile, universal, through-fixing frame anchor



Base materials



Features and benefits

- Designed for multiple fixings in either solid or hollow base materials
- Evaluated for seismic performance in shaking table testing's
- Fire resistance R90, for facade application
- Sleeve without protrusions allows easy through fixing
- Immediate expansion prevents rotation in hollow blocks
- Effective clamping on uneven surfaces
- ETA approved

Installation

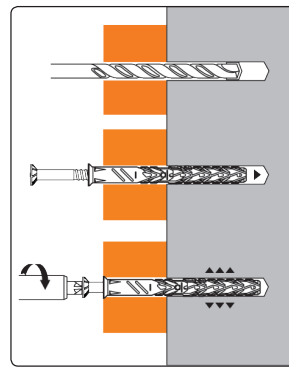

Approvals and certifications



ETA-13/1066
ETAG 020



Fire resistance
R90

Applications

- Doors and windows frames
- Prefab insulation panels
- Façades frameworks
- Window guards
- Wooden roof lathing
- Runners

Technical data

Anchor material	polyamide 6
Screw material	zinc plated carbon steel
Installation temperature	-5°C ÷ +40°C
Working temperature	-40°C ÷ +80°C

Ø	Application conditions in mm		Recommended tensile loads - Nrec in kN (1kN - 100 Kg)				
	Ø drilling	Embedment depth	Non-cracked concrete C20/25	Solid brick	Unrendered concrete hollow block	Unrendered hollow brick	Aerated concrete
8	8	50	1,20	0,90	0,30	0,60	0,21 *
10	10	50	2,20	0,90	0,30	0,60	0,21 *

Consult the technical documentation and check or take various adequate safety factors as applicable.
* Embedment depth 70 mm

T66/V TORX COUNTERSUNK FLAT HEAD SCREW - TORX



Description	Ø drilling (mm)	Drilling depth (mm)	Anchor length (mm)	Embedment depth (mm)	Max. fixing thickness (mm)	Dimension wrench	Pack (pcs.)	Code
T66/V TORX 8x60/10	8	60	60	50	10	TX 30	50	567850
T66/V TORX 8x80/30	8	60	80	50	30	TX 30	50	567851
T66/V TORX 8x100/50	8	60	100	50	50	TX 30	50	567852
T66/V TORX 8x120/70	8	60	120	50	70	TX 30	50	567853
T66/V TORX 8x150/100	8	60	150	50	100	TX 30	50	567854
T66/V TORX 10x80/30	10	60	80	50*	30	TX 40	50	567857
T66/V TORX 10x100/50	10	60	100	50*	50	TX 40	50	567858
T66/V TORX 10x120/70	10	60	120	50*	70	TX 40	50	567859
T66/V TORX 10x140/90	10	60	140	50*	90	TX 40	50	567860
T66/V TORX 10x160/110	10	60	160	50*	110	TX 40	50	567861
T66/V TORX 10x180/130	10	60	180	50*	130	TX 40	50	567862
T66/V TORX 10x200/150	10	60	200	50*	150	TX 40	50	567863
T66/V TORX 10x230/180	10	60	230	50*	180	TX 40	50	567864
T66/V TORX 10x260/210	10	60	260	50*	210	TX 40	50	567865
T66/V TORX 10x280/230	10	60	280	50*	230	TX 40	50	567866
T66/V TORX 10x300/250	10	60	300	50*	250	TX 40	50	567867

* also certified with a minimum embedment depth of 40 mm, for applications on concrete
 * also certified with a minimum embedment depth of 70 mm, for applications on lightened materials

T66/V TER W HEX HEAD FLANGED SCREW - TORX



Description	Ø drilling (mm)	Drilling depth (mm)	Anchor length (mm)	Embedment depth (mm)	Max. fixing thickness (mm)	Dimension wrench	Pack (pcs.)	Code
T66/V TER W 10x60/10	10	60	60	50*	10	H 13/TX 40	50	567868
T66/V TER W 10x80/30	10	60	80	50*	30	H 13/TX 40	50	567869
T66/V TER W 10x100/50	10	60	100	50*	50	H 13/TX 40	50	567870
T66/V TER W 10x120/70	10	60	120	50*	70	H 13/TX 40	50	567871
T66/V TER W 10x140/90	10	60	140	50*	90	H 13/TX 40	50	567872
T66/V TER W 10x160/110	10	60	160	50*	110	H 13/TX 40	50	567873
T66/V TER W 10x180/130	10	60	180	50*	130	H 13/TX 40	50	567874
T66/V TER W 10x200/150	10	60	200	50*	150	H 13/TX 40	50	567875

* also certified with a minimum embedment depth of 40 mm, for applications on concrete
 * also certified with a minimum embedment depth of 70 mm, for applications on lightened materials

T66/V AM STUD HEAD SCREW AND ANTI-TAMPERING INSERT - TORX



Description	Ø drilling (mm)	Drilling depth (mm)	Anchor length (mm)	Embedment depth (mm)	Max. fixing thickness (mm)	Dimension wrench	Pack (pcs.)	Code
T66/V AM 10x100/50	10	60	100	50*	50	TX 40	25	569465
T66/V AM 10x120/70	10	60	120	50*	70	TX 40	25	569466
T66/V AM 10x140/90	10	60	140	50*	90	TX 40	25	569467
T66/V AM 10x160/110	10	60	160	50*	110	TX 40	25	569468
T66/V AM 10x180/130	10	60	180	50*	130	TX 40	25	569469

* also certified with a minimum embedment depth of 40 mm, for applications on concrete
 * also certified with a minimum embedment depth of 70 mm, for applications on lightened materials

T88

Universal, through-fixing frame anchor suitable for solid and hollow base materials

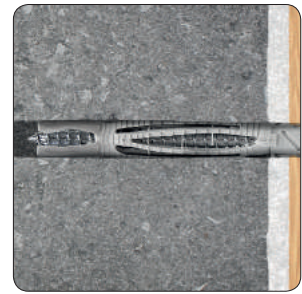
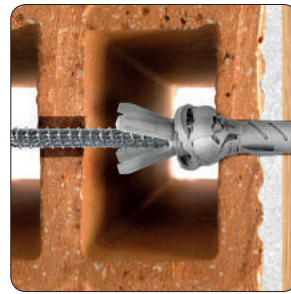

Base materials



Features and benefits

- Designed for multiple fixings in either solid or hollow base materials
- Multiple expansion principle, it self-adapts to internal geometry of base material to always ensure the best possible resistance
- Easy setting by tapping on the screw head, without risk of premature expansion
- Fire resistance R90 for façade anchors
- Knotting system always ensures effective clamping on uneven surfaces
- ETA approved

Installation

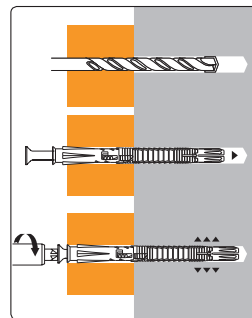

Approvals and certifications



ETA 17/0440
ETAG 020



Fire resistance
R90

Applications

- Wall plates, runners
- Doors and windows frames
- Façades frameworks
- Wooden roof lathing
- Prefab insulation panels
- Metal joinery

Technical data

Anchor material	polyamide 6
Screw material	electrolytic zinc plated steel
Installation temperature	0°C ÷ +40°C
Working temperature	-40°C ÷ +80°C

Ø	Application conditions in mm		Recommended tensile loads - Nrec in kN (1kN ~ 100 Kg)				
	Ø drilling	Embedment depth	Non-cracked concrete C20/25	Solid brick	Unrendered concrete hollow block	Unrendered hollow brick	Aerated concrete
8	8	70	1,30	1,26	0,40	0,46	-
10	10	70	1,39	1,44	0,42	0,52	0,25
12	12	70	1,56	1,48	0,44	0,56	-
16	16	90	2,20	2,08	0,84	0,62	-

* Consult the technical documentation and check or take various adequate safety factors as applicable.

T88/V TORX COUNTERSUNK FLAT HEAD SCREW - TORX



Description	Ø drilling (mm)	Drilling depth (mm)	Anchor length (mm)	Embedment depth (mm)	Max. fixing thickness (mm)	Dimension wrench	Pack (pcs.)	Code
T88/V TORX 8x80*	8	85	80	70	10	TX 30	50	567001
T88/V TORX 8x100*	8	85	100	70	30	TX 30	50	567002
T88/V TORX 8x120*	8	85	120	70	50	TX 30	50	567003
T88/V TORX 10x80	10	85	80	70	10	TX 40	50	567004
T88/V TORX 10x100	10	85	100	70	30	TX 40	50	567005
T88/V TORX 10x115	10	85	115	70	45	TX 40	50	567006
T88/V TORX 10x145	10	85	145	70	75	TX 40	50	567007
T88/V TORX 10x160	10	85	160	70	90	TX 40	50	567008
T88/V TORX 10x185	10	85	185	70	115	TX 40	50	567009
T88/V TORX 10x210	10	85	210	70	140	TX 40	50	567010

* not included in the ETA certification

T88/V COUNTERSUNK FLAT HEAD SCREW - POZIDRIV



Description	Ø drilling (mm)	Drilling depth (mm)	Anchor length (mm)	Embedment depth (mm)	Max. fixing thickness (mm)	Pack (pcs.)	Code
T88/V 8x80*	8	85	80	70	10	50	566736
T88/V 8x100*	8	85	100	70	30	50	566737
T88/V 8x120*	8	85	120	70	50	50	566738
T88/V 10x80	10	85	80	70	10	50	566753
T88/V 10x100	10	85	100	70	30	50	566754
T88/V 10x115	10	85	115	70	45	50	566755
T88/V 10x145	10	85	145	70	75	50	566756
T88/V 10x160	10	85	160	70	90	50	566757
T88/V 10x185	10	85	185	70	115	50	566758
T88/V 10x210	10	85	210	70	140	50	566759

* not included in the ETA certification

T88/V TE HEX HEAD SCREW



Description	Ø drilling (mm)	Drilling depth (mm)	Anchor length (mm)	Embedment depth (mm)	Max. fixing thickness (mm)	Dimension wrench	Pack (pcs.)	Code
T88/V TE 8x80*	8	85	80	70	10	H 10	50	566733
T88/V TE 8x100*	8	85	100	70	30	H 10	50	566734
T88/V TE 8x120*	8	85	120	70	50	H 10	50	566735
T88/V TE 10x80	10	85	80	70	10	H 13	50	566746
T88/V TE 10x100	10	85	100	70	30	H 13	50	566747
T88/V TE 10x115	10	85	115	70	45	H 13	50	566748
T88/V TE 10x145	10	85	145	70	75	H 13	50	566749
T88/V TE 10x160	10	85	160	70	90	H 13	50	566750
T88/V TE 10x185	10	85	185	70	115	H 13	50	566751
T88/V TE 10x210	10	85	210	70	140	H 13	50	566752

* not included in the ETA certification

T88/V TER HEX HEAD SCREW AND WASHER



Description	Ø drilling (mm)	Drilling depth (mm)	Anchor length (mm)	Embedment depth (mm)	Max. fixing thickness (mm)	Dimension wrench	Pack (pcs.)	Code
T88/V TER 12x120*	12	85	120	70	50	H 17	25	566765
T88/V TER 12x145*	12	85	145	70	75	H 17	25	566766
T88/V TER 12x165*	12	85	165	70	95	H 17	25	566767
T88/V TER 12x185*	12	85	185	70	115	H 17	25	566768
T88/V TER 12x210*	12	85	210	70	140	H 17	25	566769
T88/V TER 16x145*	16	110	145	90	55	H 19	25	566785
T88/V TER 16x165*	16	110	165	90	75	H 19	25	566786
T88/V TER 16x185*	16	110	185	90	95	H 19	25	566787
T88/V TER 16x200*	16	110	200	90	110	H 19	25	566788
T88/V TER 16x270*	16	110	270	90	180	H 19	15	566789

* not included in the ETA certification

APS

Through-fixing frame anchor with double length expansion sleeve



Base materials



Features and benefits

- Quick and easy pass-through installation
- Low torque expansion
- Effective grip provided by 6 anti-rotation fins allows reliable installation in all recommended base material
- Double length expansion portion ensures satisfying performance

Applications

- Doors and windows frames
- Prefab insulation panels
- Wooden roof lathing
- Window guards

Installation

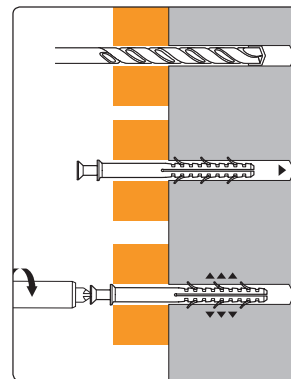

Technical data

Anchor material	polyamide 6
Screw material	electrolytic zinc plated steel
Installation temperature	0°C ÷ +40°C
Working temperature	-40°C ÷ +80°C

Note: Anchors supplied with screw, non-preassembled

Ø	Application conditions in mm		Recommended tensile loads - Nrec in kN (1kN ~ 100 Kg)		
	Ø drilling	Embedment depth	Non-cracked concrete C20/25	Solid brick	Unrendered hollow brick
8	8	70	0,90	0,80	0,23
10	10	70	1,10	0,95	0,30

Consult the technical documentation and check or take various adequate safety factors as applicable.

APS SLEEVE



Description	Ø drilling (mm)	Drilling depth (mm)	Anchor length (mm)	Embedment depth (mm)	Ø screw (mm)	Min. screw length* (mm)	Max. fixing thickness (mm)	Pack (pcs.)	Code
APS 8x80	8	85	80	70	5,5	85	-	100	8722505
APS 8x100	8	85	100	70	5,5	105	-	50	8722506
APS 8x120	8	85	120	70	5,5	125	-	50	8722512
APS 10x80	10	85	80	70	7	85	-	50	8722507
APS 10x100	10	85	100	70	7	105	-	50	8722508
APS 10x115	10	85	115	70	7	120	-	50	8722509
APS 10x135	10	85	135	70	7	140	-	50	8722510
APS 10x160	10	85	160	70	7	165	-	50	8722511
APS/I 8x80 industrial	8	85	80	70	5,5	85	-	6000	8722605
APS/I 8x100 industrial	8	85	100	70	5,5	105	-	4000	8722606
APS/I 8x120 industrial	8	85	120	70	5,5	125	-	3000	8722612
APS/I 10x80 industrial	10	85	80	70	7	85	-	4000	8722607
APS/I 10x100 industrial	10	85	100	70	7	105	-	3000	8722608
APS/I 10x115 industrial	10	85	115	70	7	120	-	2500	8722609
APS/I 10x135 industrial	10	85	135	70	7	140	-	2000	8722610
APS/I 10x160 industrial	10	85	160	70	7	165	-	1500	8722611

* screw not supplied

APS/V COUNTERSUNK FLAT HEAD SCREW - POZIDRIV



Description	Ø drilling (mm)	Drilling depth (mm)	Anchor length (mm)	Embedment depth (mm)	Max. fixing thickness (mm)	Pack (pcs.)	Code
APS/V 8x80	8	85	80	70	10	50	8722555
APS/V 8x100	8	85	100	70	30	25	8722556
APS/V 8x120	8	85	120	70	50	25	8722562
APS/V 10x80	10	85	80	70	10	25	8722557
APS/V 10x100	10	85	100	70	30	25	8722558
APS/V 10x115	10	85	115	70	45	25	8722559
APS/V 10x135	10	85	135	70	65	25	8722560
APS/V 10x160	10	85	160	70	90	25	8722561
APS/V 8x80 blister	8	85	80	70	10	10	565997
APS/V 8x100 blister	8	85	100	70	30	10	565449
APS/V 8x120 blister	8	85	120	70	50	10	565998
APS/V 10x80 blister	10	85	80	70	10	6	565999
APS/V 10x100 blister	10	85	100	70	30	8	565450

APS/V TORX COUNTERSUNK FLAT HEAD SCREW - TORX



Description	Ø drilling (mm)	Drilling depth (mm)	Anchor length (mm)	Embedment depth (mm)	Max. fixing thickness (mm)	Dimension wrench	Pack (pcs.)	Code
APS/V TORX 8x80	8	85	80	70	10	TX 30	50	8722545
APS/V TORX 8x100	8	85	100	70	30	TX 30	25	8722546
APS/V TORX 8x120	8	85	120	70	50	TX 30	25	8722552
APS/V TORX 10x80	10	85	80	70	10	TX 40	25	8722547
APS/V TORX 10x100	10	85	100	70	30	TX 40	25	8722548
APS/V TORX 10x115	10	85	115	70	45	TX 40	25	8722549
APS/V TORX 10x135	10	85	135	70	65	TX 40	25	8722550
APS/V TORX 10x160	10	85	160	70	90	TX 40	25	8722551
APS/V TORX 10x200	10	85	200	70	120	TX 40	25	8722553

APS/V TE HEX HEAD SCREW



Description	Ø drilling (mm)	Drilling depth (mm)	Anchor length (mm)	Embedment depth (mm)	Max. fixing thickness (mm)	Dimension wrench	Pack (pcs.)	Code
APS/V TE 8x80	8	85	80	70	10	H 10	50	8722575
APS/V TE 8x100	8	85	100	70	30	H 10	25	8722576
APS/V TE 8x120	8	85	120	70	50	H 10	25	8722582
APS/V TE 10x80	10	85	80	70	10	H 13	25	8722577
APS/V TE 10x100	10	85	100	70	30	H 13	25	8722578
APS/V TE 10x115	10	85	115	70	45	H 13	25	8722579
APS/V TE 10x135	10	85	135	70	65	H 13	25	8722580
APS/V TE 10x160	10	85	160	70	90	H 13	25	8722581

APS/V TER HEX HEAD SCREW AND WASHER



Description	Ø drilling (mm)	Drilling depth (mm)	Anchor length (mm)	Embedment depth (mm)	Max. fixing thickness (mm)	Dimension wrench	Pack (pcs.)	Code
APS/V TER 12x130	12	85	130	70	60	H 17	25	8722584
APS/V TER 12x200	12	85	200	70	130	H 17	20	8722585
APS/V TER 12x240	12	85	240	70	170	H 17	20	8722586
APS/V TER 16x140	16	100	140	80	60	H 19	20	8722587
APS/V TER 16x160	16	100	160	80	80	H 19	20	8722588
APS/V TER 16x200	16	100	200	80	120	H 19	20	8722589
APS/V TER 16x240	16	100	240	80	160	H 19	20	8722590

APR

Through-fixing frame anchor



Base materials

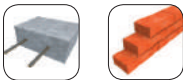

Features and benefits

- Quick and easy pass-through installation
- Low torque expansion
- Effective grip provided by 6 anti-rotation fins allows reliable installation in all recommended base material
- Double length expansion portion ensures satisfying performance

Technical data

Anchor material	polyamide 6
Screw material	electrolytic zinc plated steel
Installation temperature	0°C ÷ +40°C
Working temperature	-40°C ÷ +80°C

Note: Anchors supplied with screw, non-preassembled



Applications

- Doors and windows frames
- Prefab insulation panels
- Wooden roof lathing
- Window guards

Installation

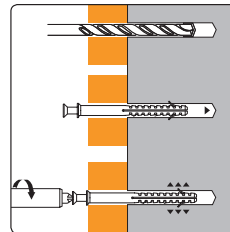

Ø	Application conditions in mm		Recommended tensile loads - Nrec in kN (1kN ~ 100 Kg)	
	Ø drilling	Embedment depth	Non-cracked concrete C20/25	Solid brick
6	6	30	0,22	0,14
8	8	40	0,50	0,45
10	10	50	0,90	0,76

Consult the technical documentation and check or take various adequate safety factors as applicable.

APR/V COUNTERSUNK FLAT HEAD SCREW - POZIDRIV



Description	Ø drilling (mm)	Drilling depth (mm)	Anchor length (mm)	Embedment depth (mm)	Max. fixing thickness (mm)	Pack (pcs.)	Code
APR/V 6x35	6	40	35	30	5	100	8722001
APR/V 6x50	6	40	50	30	20	100	8722002
APR/V 6x60	6	40	60	30	30	100	8722003
APR/V 8x60	8	55	60	40	20	50	8722004
APR/V 8x80	8	55	80	40	40	50	8722005
APR/V 8x100	8	55	100	40	60	50	8722006
APR/V 8x120	8	55	120	40	80	25	8722012
APR/V 8x135	8	55	135	40	95	25	8722013
APR/V 8x160	8	55	160	40	120	25	8722014
APR/V 10x80	10	65	80	50	30	25	8722007
APR/V 10x100	10	65	100	50	50	25	8722008
APR/V 10x115	10	65	115	50	65	20	8722009
APR/V 10x135	10	65	135	50	85	20	8722010
APR/V 10x160	10	65	160	50	110	20	8722011

ETFP

Light-duty plastic anchor for doors and windows frames



Base materials

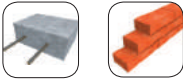

Applications

- Door and window frames

Features and benefits

- Anti-rotation fins provide grip to the frame
- Plastic sleeve prevents galvanic corrosion
- Able to compensate frame thermal expansion
- White plastic screw cap included

Technical data

Anchor material	polyamide 6
Screw material	electrolytic zinc plated steel
Installation temperature	0°C ÷ +40°C
Working temperature	-40°C ÷ +80°C

Installation

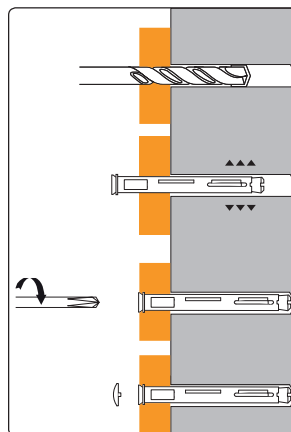

Ø	Application conditions in mm		Recommended tensile loads - Nrec in kN (1kN ~ 100 Kg)		
	Ø drilling	Embedment depth	Non-cracked concrete C20/25	Solid brick	Unrendered hollow brick
8	8	50	0,60	0,60	0,20
10	10	60	1,12	1,08	0,26

Consult the technical documentation and check or take various adequate safety factors as applicable.

ETFP PRE-MOUNTED COUNTERSUNK FLAT HEAD SCREW - POZIDRIV



Description	Ø drilling (mm)	Drilling depth (mm)	Anchor length (mm)	Ø screw (mm)	Screw length (mm)	Max. fixing thickness (mm)	Pack (pcs.)	Code
ETFP 8x75	8	65	75	5	85	25	50	8707001
ETFP 8x100	8	65	100	5	105	50	50	8707002
ETFP 8x120	8	65	120	5	125	70	50	8707003
ETFP 8x140	8	65	140	5	145	90	50	8707004
ETFP 10x75	10	75	75	6	85	15	50	8707006
ETFP 10x100	10	75	100	6	105	40	50	8707007
ETFP 10x120	10	75	120	6	125	60	50	8707008
ETFP 10x140	10	75	140	6	145	80	50	8707009
ETFP 10x160	10	75	160	6	165	100	50	8707010

JTX

Universal, light-duty, hammer-in plastic anchor

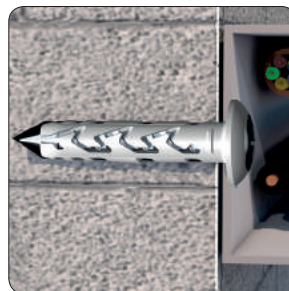

Base materials



Features and benefits

- Immediate hammer-in expansion with asymmetrical expansion fins geometry
- It self-adapts to internal geometry of base material providing increased grip compared to traditional hammer-in anchors so the same performance with shorter length
- Shorter setting times thanks to lower drilling depth required
- Available in length 30 mm, ideal either for floor applications or hollow base materials
- Large lip diameter and shape ensures perfect clamping and effective aesthetic finish

Technical data

Anchor material	polyamide 6
Screw material	electrolytic zinc plated steel
Installation temperature	-5°C ÷ +40°C
Working temperature	-40°C ÷ +80°C

Applications

- Drywall tracks
- Insulation starting profiles
- Roof flashing
- Plastic or metal trunkings
- Clips for tubes, pipes
- Perforated strip

Installation

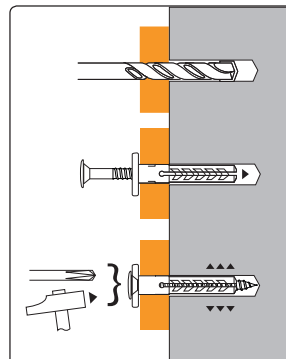

Ø	Application conditions in mm		Recommended tensile loads - Nrec in kN (1kN ~ 100 Kg)				
	Ø drilling	Depth of pose	Non-cracked concrete C20/25	Concrete hollow block	Solid brick	Unrendered hollow brick	Aerated concrete
6	6	25	0,25	0,14	0,2	0,12	0,14

Consult the technical documentation and check or take various adequate safety factors as applicable.

JTX

PRE-MOUNTED PAN HEAD SCREW NAIL WITH ROUNDED LIP - POZIDRIV



Description	Ø drilling (mm)	Drilling depth (mm)	Anchor length (mm)	Embedment depth (mm)	Ø lip (mm)	Max. fixing thickness (mm)	Pack (pcs.)	Code
JTX TB 6x30	6	35	31	25	12	3	200	568666
JTX TB 6x35	6	35	36	25	12	8	200	568667
JTX TB 6x40	6	35	41	25	12	13	100	568669

UCX

Light-duty, hammer-in, plastic anchor



Base materials



Features and benefits

- Quick hammer-in setting
- Available either with lipped or countersunk sleeve and threaded rod variants

Applications

- Drywall tracks
- Insulation starting profiles
- Roof flashing
- Battens
- Plastic or metal trunkings
- Clips for tubes, pipes
- Perforated strip

Technical data

Anchor material	polyamide 6
Screw material	electrolytic zinc plated steel
Installation temperature	0°C ÷ +40°C
Working temperature	-40°C ÷ +80°C

Installation

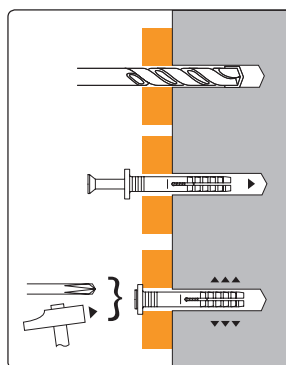

Ø	Application conditions in mm		Recommended tensile loads - Nrec in kN (1kN ~ 100 Kg)	
	Ø drilling	Depth of pose	Non-cracked concrete C20/25	Solid brick
5	5	30	0,16	0,16
6	6	30	0,20	0,20
8	8	40	0,32	0,30

Consult the technical documentation and check or take various adequate safety factors as applicable.

UCX/VM PRE-MOUNTED METRIC HEAD SCREW WITH FLAT LIP - PH



Description	Ø drilling (mm)	Drilling depth (mm)	Anchor length (mm)	Embedment depth (mm)	Ø lip (mm)	Metric screw (mm)	Pack (pcs.)	Code
UCX/VM M6/6x35	6	45	35	35	10	M6x10	100	8710014
UCX/VM M6/6x35 industrial	6	45	35	35	10	M6x10	100	8710114

UCX/V

FLAT LIP WITH PRE-MOUNTED COUNTERSUNK FLAT HEAD SCREW - POZIDRIV



Description	Ø drilling (mm)	Drilling depth (mm)	Anchor length (mm)	Embedment depth (mm)	Ø lip (mm)	Max. fixing thickness (mm)	Pack (pcs.)	Code
UCX/V 5x25	5	35	25	24	9	1	100	8710001
UCX/V 5x36	5	40	36	30	9	5	100	8710002
UCX/V 5x45	5	40	45	30	9	15	100	8710003
UCX/V 6x35	6	40	35	30	10	5	100	8710004
UCX/V 6x45	6	40	45	30	10	15	100	8710005
UCX/V 6x55	6	40	55	30	10	25	100	8710006
UCX/V 6x70	6	40	70	30	10	40	100	8710007
UCX/V 8x45	8	55	45	40	11	5	100	8710008
UCX/V 8x60	8	55	60	40	11	12	50	8710009
UCX/V 8x75	8	55	75	40	11	30	50	8710010
UCX/V 8x100	8	55	100	40	11	60	50	8710011
UCX/V 8x120	8	55	120	40	11	80	50	8710012
UCX/V 8x135	8	55	135	40	11	95	50	8710013
UCX/V 6x35 blister	6	40	35	30	10	5	20	565444
UCX/V 6x55 blister	6	40	55	30	10	25	15	565445
UCX/V 6x70 blister	6	40	70	30	10	40	15	565446
UCX/V 8x75 blister	8	55	75	40	11	30	10	565447
UCX/V 8x100 blister	8	55	100	40	11	60	6	565448
UCX/V I 5x25 industrial	5	35	25	24	9	1	6.000	8710101
UCX/V I 5x36 industrial	5	40	36	30	9	5	5.000	8710102
UCX/V I 5x45 industrial	5	40	45	30	9	15	4.000	8710103
UCX/V I 6x35 industrial	6	40	35	30	10	5	4.000	8710104
UCX/V I 6x45 industrial	6	40	45	30	10	15	3.000	8710105
UCX/V I 6x55 industrial	6	40	55	30	10	25	2.500	8710106
UCX/V I 6x70 industrial	6	40	70	30	10	40	2.000	8710107
UCX/V I 8x45 industrial	8	55	45	40	11	5	2.000	8710108
UCX/V I 8x60 industrial	8	55	60	40	11	12	1.700	8710109
UCX/V I 8x75 industrial	8	55	75	40	11	30	1.200	8710110
UCX/V I 8x100 industrial	8	55	100	40	11	60	800	8710111
UCX/V I 8x120 industrial	8	55	120	40	11	80	700	8710112
UCX/V I 8x135 industrial	8	55	135	40	11	95	500	8710113

UCX TS/V

COUNTERSUNK LIP WITH PRE-MOUNTED COUNTERSUNK FLAT HEAD SCREW - POZIDRIV



Description	Ø drilling (mm)	Drilling depth (mm)	Anchor length (mm)	Embedment depth (mm)	Ø lip (mm)	Max. fixing thickness (mm)	Pack (pcs.)	Code
UCX TS/V 4x35*	4	35	35	25	9	10	100	8710500
UCX TS/V 5x25	5	35	25	24	9	1	100	8710501
UCX TS/V 5x30	5	35	30	25	9	5	100	8710502
UCX TS/V 5x45	5	40	45	30	10	15	100	8710503
UCX TS/V 6x35	6	40	35	30	10	5	100	8710504
UCX TS/V 6x40	6	40	40	30	10	10	100	8710505
UCX TS/V 6x55	6	40	55	30	10	25	100	8710506
UCX TS/V 6x70	6	40	70	30	11	40	100	8710507
UCX TS/V 8x45	8	55	45	40	11	5	100	8710508
UCX TS/V 8x60	8	55	60	40	11	12	50	8710509
UCX TS/V 8x75	8	55	75	40	11	30	50	8710510
UCX TS/V 8x100	8	55	100	40	11	60	50	8710511
UCX TS/V 8x120	8	55	120	40	11	80	50	8710512
UCX TS/V 8x135	8	55	135	40	11	95	50	8710513
UCX TS/V 4x35* blister	4	35	35	25	9	10	25	565443
UCX TS/V I 5x25 industrial	5	35	25	24	9	1	6.000	8710401
UCX TS/V I 5x30 industrial	5	35	30	25	9	5	5.000	8710402
UCX TS/V I 5x45 industrial	5	40	45	30	9	15	4.000	8710403
UCX TS/V I 6x35 industrial	6	40	35	30	10	5	4.000	8710404
UCX TS/V I 6x40 industrial	6	40	40	30	10	10	3.000	8710405
UCX TS/V I 6x55 industrial	6	40	55	30	10	25	2.500	8710406
UCX TS/V I 6x70 industrial	6	40	70	30	10	40	2.000	8710407
UCX TS/V I 8x45 industrial	8	55	45	40	11	5	2.000	8710408
UCX TS/V I 8x60 industrial	8	55	60	40	11	12	1.700	8710409
UCX TS/V I 8x75 industrial	8	55	75	40	11	30	1.200	8710410
UCX TS/V I 8x100 industrial	8	55	100	40	11	60	800	8710411
UCX TS/V I 8x120 industrial	8	55	120	40	11	80	700	8710412
UCX TS/V I 8x135 industrial	8	55	135	40	11	95	500	8710413

* Non-preassembled version, with bronzed screw

HCX

Light-duty, hammer-in, fast installation, plastic anchor with large lip



Base materials

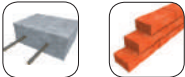

Features and benefits

- Quick hammer-in setting
- Dome lipped sleeve variant

Applications

- Drywall tracks
- Insulation starting profiles
- Roof flashing
- Signs
- Plastic or metal trunkings
- Perforated strip

Technical data

Anchor material	polyamide 6
Screw material	electrolytic zinc plated steel/painted steel/copper
Installation temperature	0°C ÷ +40°C
Working temperature	-40°C ÷ +80°C

Installation

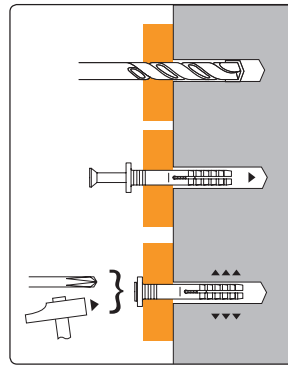

Ø	Application conditions in mm		Recommended tensile loads - Nrec in kN (1kN ~ 100 Kg)	
	Ø drilling	Depth of pose	Non-cracked concrete C20/25	Solid brick
6	6	30	0,20	0,16

Consult the technical documentation and check or take various adequate safety factors as applicable.

HCX TB/V

DOME LIP, NEUTRAL COLOUR WITH PRE-MOUNTED ZINC PLATED PAN HEAD SCREW - PH



Description	Ø drilling (mm)	Drilling depth (mm)	Anchor length (mm)	Embedment depth (mm)	Ø lip (mm)	Max. fixing thickness (mm)	Pack (pcs.)	Code
HCX TB/V 6x35	6	35	36	25	14	8	100	8709001
HCX TB/V 6x45	6	35	46	27	14	15	100	8709002
HCX TB/V 6x60	6	35	62	27	14	30	100	8709003
HCX TB/V 6x70	6	35	72	27	14	35	50	8709004
HCX TB/V I 6x35 industrial	6	35	36	25	14	8	3.500	8709031
HCX TB/V I 6x45 industrial	6	35	46	27	14	15	2.500	8709032
HCX TB/V I 6x60 industrial	6	35	62	27	14	30	2.000	8709033
HCX TB/V I 6x70 industrial	6	35	72	27	14	35	1.500	8709034

HCX TB/VZN

DOME LIP, DARK BROWN WITH PRE-MOUNTED ZINC PLATED PAN HEAD SCREW - PH



Description	Ø drilling (mm)	Drilling depth (mm)	Anchor length (mm)	Embedment depth (mm)	Ø lip (mm)	Max. fixing thickness (mm)	Pack (pcs.)	Code
HCX TB/VZN 6x35	6	35	35	25	13	8	100	8709306
HCX TB/VZN 6x45	6	35	45	27	13	15	100	8709307

HCX TB/VR

DOME LIP, DARK BROWN WITH PRE-MOUNTED COPPER PAN HEAD SCREW - PH



Description	Ø drilling (mm)	Drilling depth (mm)	Anchor length (mm)	Embedment depth (mm)	Ø lip (mm)	Max. fixing thickness (mm)	Pack (pcs.)	Code
HCX TB/VR 6x35	6	35	36	25	14	8	100	8709301
HCX TB/VR 6x45	6	35	46	27	14	15	100	8709302
HCX TB/VR I 6x35 industrial	6	35	36	25	14	8	3.500	8709331
HCX TB/VR I 6x45 industrial	6	35	46	27	14	15	2.500	8709332

HCX TPL/V

FLAT LIP, NEUTRAL COLOUR WITH PRE-MOUNTED ZINC PLATED PAN HEAD SCREW - PH



Description	Ø drilling (mm)	Drilling depth (mm)	Anchor length (mm)	Embedment depth (mm)	Ø lip (mm)	Max. fixing thickness (mm)	Pack (pcs.)	Code
HCX TPL/V 6x35	6	35	36	25	14	8	100	8709201
HCX TPL/V 6x45	6	35	46	27	14	15	100	8709202
HCX TPL/V 6x60	6	35	62	27	14	30	100	8709203
HCX TPL/V 6x70	6	35	72	27	14	35	50	8709204

ETCD

Light-duty, hammer-in, zinc-aluminium alloy anchor



Base materials

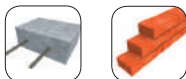

Features and benefits

- Quick hammer-in setting
- Corrosion resistant, thanks to the zinc-aluminium alloy body
- Dome lip \varnothing 14 mm ensure effective clamping

Applications

- Insulation starting profiles
- Roof flashing
- Signs
- Plastic or metal trunkings
- Perforated strip

Technical data

Anchor material: zinc-aluminium alloy (zamak)

Installation

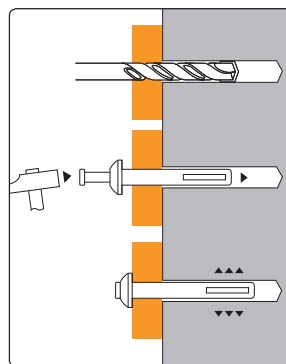

Ø	Application conditions in mm		Recommended tensile loads - Nrec in kN (1kN ~ 100 Kg)	
	Ø drilling	Depth of pose	Non-cracked concrete C20/25	Solid brick
6	6	22	0,24	0,21

Consult the technical documentation and check or take various adequate safety factors as applicable.

ETCD

PRE-MOUNTED ZINC PLATED NAIL



Description	Ø drilling (mm)	Drilling depth (mm)	Anchor length (mm)	Embedment depth (mm)	Max. fixing thickness (mm)	Pack (pcs.)	Code
ETCD 6x40	6	30	40	22	15	100	704005
ETCD 6x50	6	30	50	22	20	100	704006

BLUEFIX



INNOVATIVE BI-MATERIAL PLASTIC ANCHOR!

Great performance on concrete,
incredible on plasterboard,
the best on unrendered hollow
bricks!

The innovative bi-material technology:

- allows the **application on different construction supports** as universal plastic plugs but thanks to the high-resistance bi-material Bluefix outperforms them.
- **high performances** on all supports, **higher grip values on plasterboard and Unrendered hollow bricks!**
- expands or knots, **adapting automatically to the support structure**

New Ø5



LIGHTWEIGHT AND SPECIAL MECHANICAL ANCHORS

BI-MATERIAL

SUPER PERFORMING FIXING



GRIP WITHOUT COMPARISONS

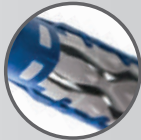

FLEXIBLE LIP

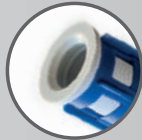

FLEXIBILITY
INNOVATIVE ELASTOMERIC MATERIAL

INCREDIBLE TIGHTENING TORQUE



NO ROTATION



PERFECT ALSO ON PLASTERBOARD



RESISTANCE
SPECIAL REINFORCED NYLON



BLUEFIX

High-performance, universal, light-duty, bi-material anchor



Base materials



Features and benefits

- Very high resistance ensured by bi-materials principle
- 4-ways multidirectional expansion and knotting principle always fits various base materials
- Flexible lip allows either through fixing or flush installation
- The effective 4 anti-rotation fins allow perfect functioning especially in hollow blocks.
- Reinforced materials portions allow the best control during the installation
- Reinforced polymer on the top cone and along the whole length ensure unmatched resistance
- The best flexibility, every size is compatible with a wide range of screw types and diameter
- BLUEFIX diameter 8 mm has been tested for anchorages under seismic loads

Applications

- Clamps, clips, brackets for tubes, pipes for HVAC or electrical installations
- Basket trays
- Plastic or metal trunkings
- Heaters, fans
- Electrical panels, fuse boxes
- Lighting
- Drywall tracks
- Shelves, cabinets



Installation

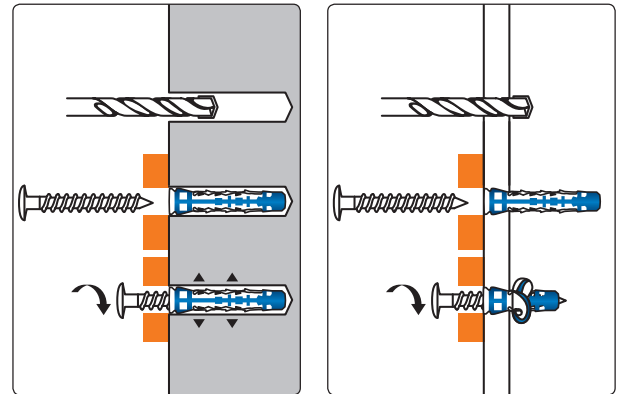

Technical data

Anchor material	reinforced polyamide + elastomeric polyamide
Screw material	electrolytic zinc plated steel
Installation temperature	0°C ÷ +40°C
Working temperature	-20°C ÷ +70°C

Note: screw not pre-mounted on VA, KS, HS anchors

Ø	Application conditions in mm			Recommended tensile loads - Nrec in kN (1kN ~ 100 Kg)						
	Ø drilling	Screw (type VA)	Drilling depth	Non-cracked concrete C20/25	Concrete hollow block	Solid brick	Unrendered hollow brick	Aerated concrete	Plasterboard (13 mm)	Plasterboard (13+13 mm)
5	5	3,5x40	30	0,35	0,30	0,34	0,25	-	0,10	-
6	6	4,5x45	35	0,38	0,30	0,34	0,27	0,14	0,10	0,13
8	8	5,0x60	50	0,46	0,42	0,44	0,40	0,21	0,12	0,21

Consult the technical documentation and check or take various adequate safety factors as applicable.

BLUEFIX SLEEVE



Description	Ø drilling (mm)	Drilling depth (mm)	Anchor length (mm)	Ø screw (mm)	Min. screw length (mm)	Max. fixing thickness (mm)	Pack (pcs.)	Code
BLUEFIX 5x30	5	40	30	3,0 ÷ 4,0	35	-	100	568284
BLUEFIX 6x35	6	50	35	3,5 ÷ 5	40	-	100	568286
BLUEFIX 8x50	8	65	50	4,5 ÷ 6	55	-	50	568287
BLUEFIX 6x35 <i>blister</i>	6	50	35	3,5 ÷ 5	40	-	20	565537
BLUEFIX 8x50 <i>blister</i>	8	65	50	4,5 ÷ 6	55	-	15	565538

BLUEFIX/VA COUNTERSUNK FLAT HEAD SCREW - POZIDRIV

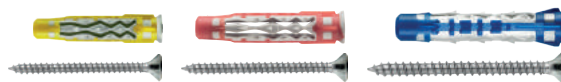

Description	Ø drilling (mm)	Drilling depth (mm)	Anchor length (mm)	Ø screw (mm)	Screw length (mm)	Max. fixing thickness (mm)	Pack (pcs.)	Code
BLUEFIX/VA 5x30	5	40	30	3,5	40	5	100	565539
BLUEFIX/VA 6x35	6	50	35	4,5	50	10	100	565540
BLUEFIX/VA 8x50	8	65	50	5	65	10	50	565541
BLUEFIX/VA 5x30 <i>can</i>	5	40	30	3,5	40	5	300	565547
BLUEFIX/VA 6x35 <i>can</i>	6	50	35	4,5	50	10	250	565542
BLUEFIX/VA 8x50 <i>can</i>	8	65	50	5	65	10	150	565548
BLUEFIX/VA 6x35 <i>blister</i>	6	50	35	4,5	50	10	15	565535
BLUEFIX/VA 8x50 <i>blister</i>	8	65	50	5	65	10	10	565536

BLUEFIX/HS HEX HEAD FLANGED SCREW - TORX



Description	Ø drilling (mm)	Drilling depth (mm)	Anchor length (mm)	Ø screw (mm)	Screw length (mm)	Max. fixing thickness (mm)	Pack (pcs.)	Code
BLUEFIX/HS 8x50 <i>can</i>	8	65	50	5	60	5	50	568172

BLUEFIX/KS PAN HEAD FLANGED SCREW - TORX



Description	Ø drilling (mm)	Drilling depth (mm)	Anchor length (mm)	Ø screw (mm)	Screw length (mm)	Max. fixing thickness (mm)	Pack (pcs.)	Code
BLUEFIX/KS 6x35	6	50	35	4,5	45	5	50	568179



**BLUEFIX/VA
5X30**
(565547)



**BLUEFIX/VA
6X35**
(565542)



**BLUEFIX/VA
8X50**
(565548)

T6

Universal light-duty plastic anchor with multidirectional expansion



Base materials



Features and benefits

- Easy to install, high resistance
- 6-ways multidirectional expansion and knotting principle fits both solid or hollow base materials
- Dynamic lip allows either through fixing or flush installation
- The effective anti-rotation fins allow perfect functioning especially in hollow blocks

Applications

- Clamps, clips, brackets for tubes, pipes for HVAC or electrical installations
- Plastic or metal trunkings
- Lighting
- Drywall tracks
- Shelves, lightweight cabinets

Installation

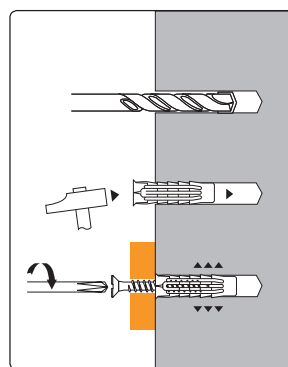

Technical data

Anchor material	polyamide 6
Screw material	electrolytic zinc plated steel
Installation temperature	-5°C ÷ +40°C
Working temperature	-40°C ÷ +80°C

Ø	Application conditions in mm			Recommended tensile loads - Nrec in kN (1kN ~ 100 Kg)			
	Ø drilling	Screw (type VA)	Drilling depth	Non-cracked concrete C20/25	Concrete hollow block	Solid brick	Unrendered hollow brick
5	5	4x30	35	0,28	0,23	0,20	0,17
6	6	4,5x40	40	0,28	0,30	0,26	0,19
8	8	5x50	55	0,50	0,43	0,35	0,23
10	10	6x60	65	0,70	0,46	0,60	0,25
12	12	8x80	75	1,50	0,52	0,80	0,30
14	14	10x100	90	2,10	0,56	0,90	0,36

Consult the technical documentation and check or take various adequate safety factors as applicable.

T6 SLEEVE



Description	Ø drilling (mm)	Drilling depth (mm)	Anchor length (mm)	Ø screw (mm)	Min. screw length (mm)	Max. fixing thickness (mm)	Pack (pcs.)	Code
T6 5x25	5	35	25	3 ÷ 4	30	-	100	565385
T6 6x30	6	40	30	4 ÷ 5	35	-	100	565386
T6 6x45	6	55	45	4 ÷ 5	50	-	100	565757
T6 8x40	8	55	40	4,5 ÷ 6	45	-	100	565387
T6 8x50	8	65	50	4,5 ÷ 6	55	-	50	565758
T6 10x50	10	65	50	6 ÷ 8	55	-	50	565388
T6 10x60	10	75	60	6 ÷ 8	65	-	25	565759
T6 12x60	12	75	60	8 ÷ 10	65	-	25	565281
T6 14x70	14	90	70	10 ÷ 12	75	-	20	565282
T6 5x25 blister	5	35	25	3 ÷ 4	30	-	35	565964
T6 6x30 blister	6	40	30	4 ÷ 5	35	-	30	565965
T6 8x40 blister	8	55	40	4,5 ÷ 6	45	-	20	565966
T6 10x50 blister	10	65	50	6 ÷ 8	55	-	10	565967
T6 12x60 blister	12	75	60	8 ÷ 10	65	-	5	565968
T6/E 5x25 bag	5	35	25	3 ÷ 4	30	-	1000	565936
T6/E 6x30 bag	6	40	30	4 ÷ 5	35	-	1000	565937
T6/E 8x40 bag	8	55	40	4,5 ÷ 6	45	-	1000	565938
T6/E 10x50 bag	10	65	50	6 ÷ 8	55	-	500	565939

T6/VA ZINC PLATED COUNTERSUNK FLAT HEAD SCREW - POZIDRIV



Description	Ø drilling (mm)	Drilling depth (mm)	Anchor length (mm)	Ø screw (mm)	Screw length (mm)	Max. fixing thickness (mm)	Pack (pcs.)	Code
T6/VA 5x25	5	35	25	4	30	2	100	565389
T6/VA 6x30	6	40	30	4,5	40	5	100	565390
T6/VA 6x45	6	55	45	4,5	60	5	50	565882
T6/VA 8x40	8	55	40	5	50	5	50	565391
T6/VA 8x50	8	65	50	5	60	5	50	565883
T6/VA 10x50	10	65	50	6	60	5	25	565392
T6/VA 10x60	10	75	60	6	70	5	25	565884
T6/VA 5x25 blister	5	35	25	4	30	2	20	565969
T6/VA 6x30 blister	6	40	30	4,5	40	5	15	565329
T6/VA 8x40 blister	8	55	40	5	50	5	10	565401
T6/VA 10x50 blister	10	65	50	6	60	5	4	565970

T6/V TER ZINC PLATED HEX HEAD SCREW AND WASHER



Description	Ø drilling (mm)	Drilling depth (mm)	Anchor length (mm)	Ø screw (mm)	Screw length (mm)	Max. fixing thickness (mm)	Pack (pcs.)	Code
T6/V TER 8x40	8	55	40	6	50	5	50	565760
T6/V TER 10x50	10	65	50	7	70	15	50	565761
T6/V TER 12x60	12	75	60	8	80	15	50	565762
T6/V TER 14x70	14	90	70	10	100	20	25	565763

T6/VN ZINC PLATED COUNTERSUNK PAN HEAD SCREW - POZIDRIV



Description	Ø drilling (mm)	Drilling depth (mm)	Anchor length (mm)	Ø screw (mm)	Screw length (mm)	Max. fixing thickness (mm)	Pack (pcs.)	Code
T6/VN 6x30	6	40	30	4,5	40	5	100	565393
T6/VN 8x40	8	55	40	5	50	5	50	565394

T6/VX T6/VKC ZINC PLATED PAN HEAD FLANGED SCREW - POZIDRIV



Description	Ø drilling (mm)	Drilling depth (mm)	Anchor length (mm)	Ø screw (mm)	Screw length (mm)	Max. fixing thickness (mm)	Pack (pcs.)	Code
T6/VX 6x30	6	40	30	4,5	40	6	100	565395
T6/VKC 6x30 long pitch thread	6	40	30	4,5	40	6	200	568686
T6/VKC 6x30 long pitch thread	6	40	30	4,5	40	6	500	568685

E/EB

Universal light-duty plastic anchor with or without lip

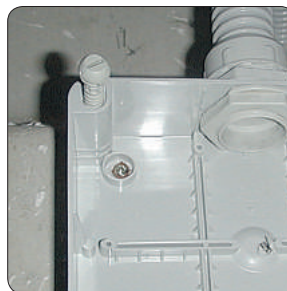

Base materials



Features and benefits

- Large and effective expansion
- High quality of polymer ensure safety and durability
- Very versatile, fits many applications in several types of base material
- Quick installation
- Available either in lipped or non-lipped variant

Applications

- Picture frames
- Bathroom fixtures
- Lighting
- Signs
- Curtain rails

Installation

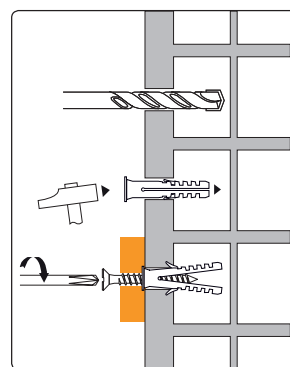
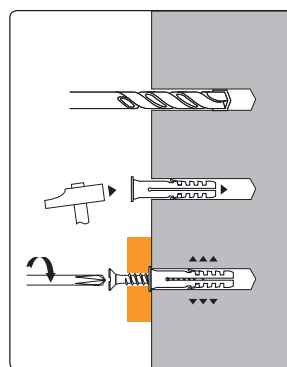

Technical data

Anchor material	polyamide 6
Screw material	zinc plated steel
Installation temperature	0°C ÷ +40°C
Working temperature	-40°C ÷ +80°C

Ø	Application conditions in mm		Recommended tensile loads - Nrec in kN (1kN ~ 100 Kg)		
	Ø drilling	Ø screw (wood type)	Non-cracked concrete C20/25	Solid brick	Unrendered hollow brick
4	4	3	0,15	0,1	0,08
5	5	4	0,24	0,23	0,14
6	6	5	0,50	0,47	0,22
7	7	5,5	0,46	0,44	0,27
8	8	6	0,86	0,82	0,28
10	10	8	1,24	1,12	-
12	12	10	2,10	1,89	-
14	14	12	4,00	-	-

Consult the technical documentation and check or take various adequate safety factors as applicable.

E SLEEVE



Description	Ø drilling (mm)	Drilling depth (mm)	Anchor length (mm)	Ø screw (mm)	Min. screw length (mm)	Max. fixing thickness* (mm)	Pack (pcs.)	Code
E 4x20	4	30	20	2 ÷ 3	25	-	200	8701001
E 5x25	5	35	25	2,5 ÷ 4	30	-	200	8701002
E 6x30	6	40	30	3,5 ÷ 5	35	-	100	8701003
E 8x40	8	55	40	4,5 ÷ 6	50	-	100	8701004
E 10x50	10	65	50	6 ÷ 8	60	-	50	8701005
E 12x60	12	75	60	8 ÷ 10	70	-	25	8701006
E 14x75	14	90	75	10 ÷ 12	90	-	20	8701007
E 14x100	14	120	100	10 ÷ 12	115	-	25	8701037
E 16x80	16	100	80	12 ÷ 14	95	-	10	8701009
E 4x20 <i>blister</i>	4	30	20	2 ÷ 3	25	-	35	565973
E 5x25 <i>blister</i>	5	35	25	2,5 ÷ 4	30	-	35	565402
E 6x30 <i>blister</i>	6	40	30	3,5 ÷ 5	35	-	30	565403
E 8x40 <i>blister</i>	7	40	30	4 ÷ 5,5	35	-	20	565404
E 10x50 <i>blister</i>	8	55	40	4,5 ÷ 6	50	-	10	565405
E/E 4x20 <i>bag</i>	4	30	20	2 ÷ 3	25	-	1.000	8701101
E/E 5x25 <i>bag</i>	5	35	25	2,5 ÷ 4	30	-	1.000	8701102
E/E 6x30 <i>bag</i>	6	40	30	3,5 ÷ 5	35	-	1.000	8701103
E/E 8x40 <i>bag</i>	8	55	40	4,5 ÷ 6	50	-	1.000	8701104
E/E 10x50 <i>bag</i>	10	65	50	6 ÷ 8	60	-	500	8701105
E/E 12x60 <i>bag</i>	12	75	60	8 ÷ 10	70	-	250	8701106
E/E 14x75 <i>bag</i>	14	90	75	10 ÷ 12	90	-	200	8701107
E/I 4x20 <i>industrial</i>	4	30	20	2 ÷ 3	25	-	100.000	8701011
E/I 5x25 <i>industrial</i>	5	35	25	2,5 ÷ 4	30	-	45.000	8701012
E/I 6x30 <i>industrial</i>	6	40	30	3,5 ÷ 5	35	-	30.000	8701013
E/I 8x40 <i>industrial</i>	8	55	40	4,5 ÷ 6	50	-	12.000	8701014
E/I 10x50 <i>industrial</i>	10	65	50	6 ÷ 8	60	-	6.000	8701015
E/I 10x60 <i>industrial</i>	10	75	60	6 ÷ 8	70	-	5.500	8701018
E/I 12x60 <i>industrial</i>	12	75	60	8 ÷ 10	70	-	3.500	8701016
E/I 14x75 <i>industrial</i>	14	90	75	10 ÷ 12	90	-	2.000	8701017
E/I 14x100 <i>industrial</i>	14	120	100	10 ÷ 12	115	-	1.000	8701035
E/I 16x80 <i>industrial</i>	16	100	80	12 ÷ 14	95	-	1.800	8701019
E/I 16x110 <i>industrial</i>	16	130	110	12 ÷ 14	125	-	1.300	8701034

* screw not supplied

E/VA

NO LIP WITH ZINC PLATED COUNTERSUNK FLAT HEAD SCREW - POZIDRIV

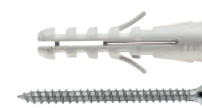

Description	Ø drilling (mm)	Drilling depth (mm)	Anchor length (mm)	Ø screw (mm)	Screw length (mm)	Max. fixing thickness (mm)	Pack (pcs.)	Code
E/VA 5x25	5	35	25	4	30	2	100	8702052
E/VA 6x30	6	40	30	4,5	40	5	100	8702053
E/VA 8x40	8	55	40	5	50	5	50	8702054
E/VA 10x50	10	65	50	6	60	5	50	8702055
E/VA 5x25 <i>blister</i>	5	35	25	4	30	2	20	565408
E/VA 6x30 <i>blister</i>	6	40	30	4,5	40	5	15	565409
E/VA 8x40 <i>blister</i>	8	55	40	5	50	5	10	565410
E/VA 10x50 <i>blister</i>	10	65	50	6	60	5	4	565411

EB LIPPED ANCHOR



Description	Ø drilling (mm)	Drilling depth (mm)	Anchor length (mm)	Ø screw (mm)	Min. screw length* (mm)	Max. fixing thickness (mm)	Pack (pcs.)	Code
EB 5x25	5	35	25	2,5 ÷ 4	30	-	200	8701052
EB 6x30	6	40	30	3,5 ÷ 5	35	-	100	8701053
EB 8x40	8	55	40	4,5 ÷ 6	50	-	100	8701054
EB 10x50	10	65	50	6 ÷ 8	60	-	50	8701055
EB 10x60	10	75	60	6 ÷ 8	70	-	50	8701058
EB 12x60	12	75	60	8 ÷ 10	70	-	25	8701056
EB/E 5x25 <i>bag</i>	5	35	25	2,5 ÷ 4	30	-	1.000	8701152
EB/E 6x30 <i>bag</i>	6	40	30	3,5 ÷ 5	35	-	1.000	8701153
EB/E 8x40 <i>bag</i>	8	55	40	4,5 ÷ 6	50	-	1.000	8701154
EB/E 10x50 <i>bag</i>	10	65	50	6 ÷ 8	60	-	500	8701155
EB/I 5x25 <i>industrial</i>	5	35	25	2,5 ÷ 4	30	-	45.000	8701062
EB/I 6x30 <i>industrial</i>	6	40	30	3,5 ÷ 5	35	-	25.000	8701063
EB/I 8x40 <i>industrial</i>	8	55	40	4,5 ÷ 6	50	-	11.000	8701064
EB/I 10x50 <i>industrial</i>	10	65	50	6 ÷ 8	60	-	6.000	8701065

* screw not supplied

EB/VA LIPPED WITH ZINC PLATED COUNTERSUNK FLAT HEAD SCREW - POZIDRIV



Description	Ø drilling (mm)	Drilling depth (mm)	Anchor length (mm)	Ø screw (mm)	Screw length (mm)	Max. fixing thickness (mm)	Pack (pcs.)	Code
EB/VA 5x25	5	35	25	4	30	2	100	8702262
EB/VA 6x30	6	40	30	4,5	40	5	100	8702263
EB/VA 6x30 - 5,0x40 screw	6	40	30	5	40	5	200	569543
EB/VA 8x40	8	55	40	5	50	5	50	8702264
EB/VA 10x50	10	65	50	6	60	5	50	8702265
EB/VA 5x25 <i>blister</i>	5	35	25	4	30	2	20	565977
EB/VA 6x30 <i>blister</i>	6	40	30	4,5	40	5	15	565978
EB/VA 8x40 <i>blister</i>	8	55	40	5	50	5	10	565979
EB/VA 10x50 <i>blister</i>	10	65	50	6	60	5	4	565980

EB/P LIPPED, PACKED WITH MOUNTING ACCESSORIES

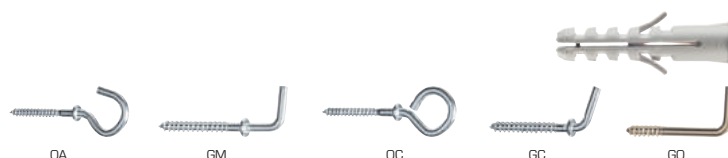

Description	Accessorio	Ø drilling (mm)	Drilling depth (mm)	Anchor length (mm)	Ø screw (mm)	Screw length (mm)	Pack (pcs.)	Code
EB/P OA 6x30	eye hook	6	40	30	4	35	100	8702423
EB/P GM 6x30	medium hook	6	40	30	4	35	100	8702413
EB/P OC 6x30	closed eye hook	6	40	30	4	35	100	8702433
EB/P GC 6x30	short hook	6	40	30	4	35	100	8702403
E/P GO 4x20	brass hook	4	30	20	2,5	30	10	8702443
EB/P GC 6x30 <i>blister</i>	short hook	6	40	30	4	35	10	565414
EB/P GM 6x30 <i>blister</i>	medium hook	6	40	30	4	35	10	565415
EB/P OA 6x30 <i>blister</i>	eye hook	6	40	30	4	35	10	565416
EB/P OC 6x30 <i>blister</i>	closed eye hook	6	40	30	4	35	10	565417
E/P GO 4x20 <i>blister</i>	brass hook	4	30	20	2,5	30	10	565418

T4

Universal light-duty plastic anchor, especially recommended for Unrendered hollow bricks masonry structures



Base materials



Features and benefits

- Easy to install, high resistance
- 4-ways multidirectional expansion and undercut principle fits both solid or hollow base materials
- The effective 12 anti-rotation fins allow perfect functioning especially in hollow blocks
- Special reinforced fins along the sleeve increase capacity in solid base materials

Installation

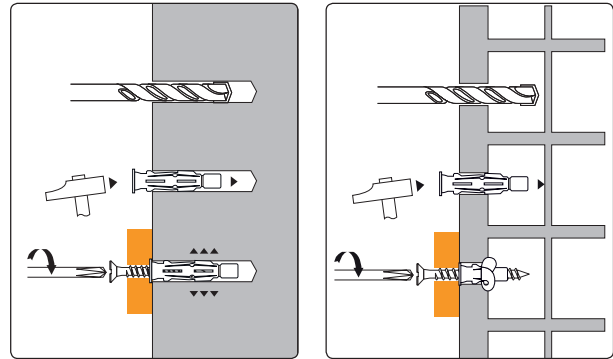

Technical data

Anchor material	polyamide 6
Screw material	zinc plated steel
Installation temperature	-5°C ÷ +40°C
Working temperature	-40°C ÷ +80°C

Applications

- Plastic trunkings
- Bathroom fixtures
- Lighting
- Signs, curtain rails

Ø	Application conditions in mm			Recommended tensile loads - Nrec in kN (1kN ~ 100 Kg)								
	Ø drilling	Screw (type VA)	Drilling depth	Non-cracked concrete C20/25	Concrete hollow block	Solid brick	Unrendered hollow brick	Aerated concrete	Plasterboard (10 mm)	Plasterboard (13 mm)	Plasterboard (13+13 mm)	
6	6	3,5x45	45	0,26	0,26	0,26	0,30	0,08	0,08	0,08	-	
6	6	3,5x55	55	0,32	0,40	0,32	0,30	0,09	-	0,10	0,18	
8	8	4,5x60	60	0,50	0,50	0,48	0,38	0,11	-	0,12	0,26	
10	10	6,0x80	80	0,66	0,64	0,56	0,42	0,19	-	0,12	0,32	

Consult the technical documentation and check or take various adequate safety factors as applicable.

T4/VA

ZINC PLATED COUNTERSUNK FLAT HEAD SCREW - POZIDRIV



Description	Ø drilling (mm)	Drilling depth (mm)	Anchor length (mm)	Ø screw (mm)	Screw length (mm)	Max. fixing thickness (mm)	Pack (pcs.)	Code
T4/VA 6x35	6	45	45	3,5	45	10	100	566135
T4/VA 6x45	6	55	55	3,5	55	10	50	566136
T4/VA 8x50	8	65	60	4,5	60	10	50	566137
T4/VA 10x60	10	75	80	6	80	20	25	566138
T4/VA 6x35 blister	6	45	45	3,5	45	10	10	566019
T4/VA 6x45 blister	6	55	55	3,5	55	10	10	566020
T4/VA 8x50 blister	8	65	60	4,5	60	10	8	566021
T4/VA 10x60 blister	10	75	80	6	80	20	4	566022

TPF-TPFC

Universal light-duty polyethylene anchor



Base materials



Features and benefits

- Easy to install, high resistance, for both solid or hollow base materials
- 3-ways expansion in solid base materials
- Undercut principle in hollow blocks or boards
- Effective anti-rotation fins allow perfect functioning especially in hollow blocks
- Available either in lipped or non-lipped variant

Applications

- Plastic trunkings
- Bathroom fixtures
- Lighting
- Signs
- Curtain rails

Installation

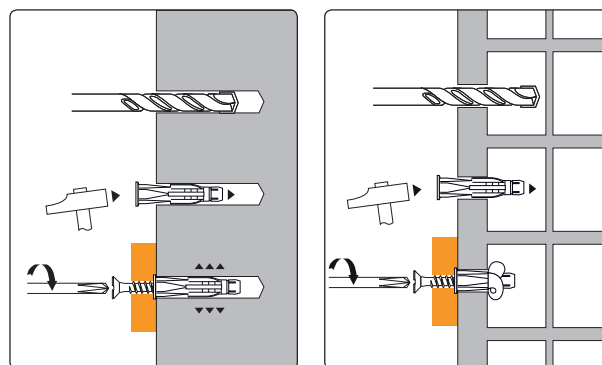

Technical data

Anchor material	HD polyethylene
Screw material	zinc plated steel
Installation temperature	0°C ÷ +40°C
Working temperature	-40°C ÷ +80°C

Ø	Application conditions in mm		Recommended tensile loads - N _{rec} in kN (1kN ~ 100 Kg)			
	Ø drilling	Ø screw (wood type)	Non-cracked concrete C20/25	Solid brick	Unrendered hollow brick	Plasterboard (13 mm)
5	5	4	0,16	0,16	0,16	0,04
6	6	4,5	0,28	0,28	0,22	0,04
8	8	6	0,40	0,40	0,30	0,09
10	10	7	0,60	0,60	0,32	0,09
12	12	8	0,70	0,68	0,32	0,09

Consult the technical documentation and check or take various adequate safety factors as applicable.

TPFC LIPPED ANCHOR



Description	Ø drilling (mm)	Drilling depth (mm)	Anchor length (mm)	Ø screw (mm)	Min. screw length (mm)	Max. fixing thickness (mm)	Pack (pcs.)	Code
TPFC 6x38	6	50	38	4 ÷ 4,5	45	-	100	8705111
TPFC 8x51	8	65	51	5 ÷ 6	55	-	50	8705112
TPFC 10x61	10	75	61	6 ÷ 7	65	-	25	8705113
TPFC 6x38 bag	6	50	38	4 ÷ 4,5	45	-	1.000	8705131
TPFC 6x51 bag	6	60	51	4 ÷ 4,5	55	-	1.000	8705135
TPFC 8x51 bag	8	65	51	5 ÷ 6	55	-	1.000	8705132
TPFC 10x61 bag	10	75	61	6 ÷ 7	65	-	500	8705133
TPFC/I 5x31 industrial	5	40	31	3 ÷ 4	35	-	25.000	8705184
TPFC/I 6x38 industrial	6	50	38	4 ÷ 4,5	45	-	20.000	8705181
TPFC/I 6x51 industrial	6	60	51	4 ÷ 4,5	55	-	14.000	8705185
TPFC/I 8x51 industrial	8	65	51	5 ÷ 6	55	-	9.000	8705182
TPFC/I 10x61 industrial	10	75	61	6 ÷ 7	65	-	5.000	8705183

TPF NON-LIPPED ANCHOR



Description	Ø drilling (mm)	Drilling depth (mm)	Anchor length (mm)	Ø screw (mm)	Min. screw length (mm)	Max. fixing thickness (mm)	Pack (pcs.)	Code
TPF/I 5x30 industrial	5	40	30	3 ÷ 4	35	-	30.000	8705194
TPF/I 6x37 industrial	6	50	37	4 ÷ 4,5	45	-	25.000	8705191
TPF/I 8x50 industrial	8	65	50	5 ÷ 6	55	-	10.000	8705192
TPF/I 10x60 industrial	10	75	60	6 ÷ 7	65	-	5.000	8705193

ENP

Light-duty plastic anchor with screw, hook, eyelet or angle hooks, for professional and household use

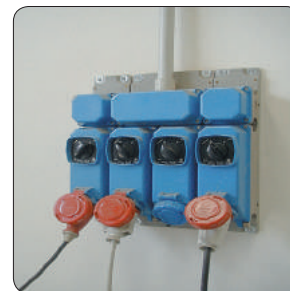

Base materials



Features and benefits

- Suitable either for solid or hollow base materials
- Good resistance and installation reliability
- Quick and easy installation thanks to the anti-rotation fins and immediate grip

Technical data

Anchor material	polyamide 6
Product, cone, screws and accessories material	electrolytic zinc plated steel

Applications

- Shelves, cabinets, furniture
- Curtain rails
- Lighting
- Lightweight racks
- Lightweight suspensions
- Heaters, fans
- Metal support brackets
- Electrical panels, fuse boxes

Installation

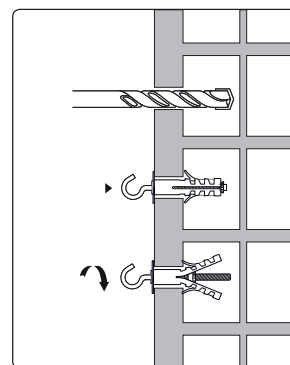
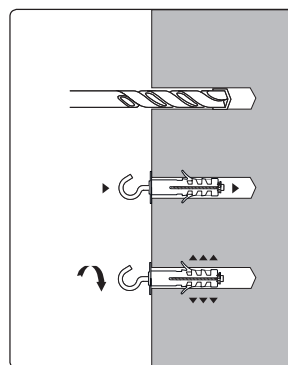

Ø	Application conditions in mm	Recommended tensile loads - Nrec in kN (1kN ~ 100 Kg)		Access breakage in kN (1 kN ~ 100 Kg)*
	Ø drilling	Non-cracked concrete C20/25	Unrendered hollow brick	
8	8	0,30	0,26	0,26
9	9	0,44	0,36	0,36
12	12	0,80	0,40	0,40

* Accessories range representative value
Consult the technical documentation and check or take various adequate safety factors as applicable.

ENP/V COUNTERSUNK PAN HEAD SCREW - COMBINED WITH WASHER



Description	Ø drilling (mm)	Drilling depth (mm)	Anchor length (mm)	Ø rebar (mm)	Screw length (mm)	Max. fixing thickness (mm)	Pack (pcs.)	Code
ENP/V 9x40	9	55	40	M4	52	10	200	8700001
ENP/VP 9x50	9	65	50	M4	60	10	100	8700016
ENP/V 12x45	12	60	45	M5	55	10	100	8700020
ENP/VP 12x55	12	70	55	M5	62	10	50	8700035
ENP/V 9x40 blister	9	55	40	M4	52	10	6	565426
ENP/V 12x45 blister	12	60	45	M5	55	10	4	565433

ENP/GC SHORT HOOK



Description	Ø drilling (mm)	Drilling depth (mm)	Anchor length (mm)	Ø rebar (mm)	Screw length (mm)	Max. fixing thickness (mm)	Pack (pcs.)	Code
ENP/GC 9x40	9	55	40	M4	43	4	200	8700003
ENP/GCP 9x50	9	65	50	M4	57	4	100	8700017
ENP/GC 12x45	12	60	45	M5	46	4,5	100	8700022
ENP/GCP 12x55	12	70	55	M5	60	4,5	50	8700036
ENP/GC 8x40 blister	8	55	40	M4	43	4	6	565425
ENP/GC 9x40 blister	9	55	40	M4	43	4	6	565427
ENP/GC 12x45 blister	12	60	45	M5	46	4,5	4	565434

ENP/GM MEDIUM HOOK



Description	Ø drilling (mm)	Drilling depth (mm)	Anchor length (mm)	Ø rebar (mm)	Screw length (mm)	Max. fixing thickness (mm)	Pack (pcs.)	Code
ENP/GM 9x40	9	55	40	M4	43	10	200	8700005
ENP/GM 12x45	12	60	45	M5	46	10	100	8700024
ENP/GMP 12x55	12	70	55	M5	60	10	50	8700037
ENP/GM 9x40 blister	9	55	40	M4	43	10	6	565428
ENP/GM 12x45 blister	12	60	45	M5	46	10	4	565435

ENP/GL LONG HOOK



Description	Ø drilling (mm)	Drilling depth (mm)	Anchor length (mm)	Ø rebar (mm)	Screw length (mm)	Max. fixing thickness (mm)	Pack (pcs.)	Code
ENP/GL 9x40	9	55	40	M4	43	17	100	8700007
ENP/GL 12x45	12	60	45	M5	46	19	50	8700026
ENP/GL 9x40 blister	9	55	40	M4	43	17	6	565429

ENP/OA EYE HOOK



Description	Ø drilling (mm)	Drilling depth (mm)	Anchor length (mm)	Ø rebar (mm)	Screw length (mm)	Max. fixing thickness (mm)	Pack (pcs.)	Code
ENP/OA 9x40	9	55	40	M4	43	-	100	8700009
ENP/OA 12x45	12	60	45	M5	46	-	50	8700028
ENP/OA 9x40 blister	9	55	40	M4	43	-	6	565430
ENP/OA 12x45 blister	12	60	45	M5	46	-	4	565436

ENP/OC CLOSED EYE HOOK



Description	Ø drilling (mm)	Drilling depth (mm)	Anchor length (mm)	Ø rebar (mm)	Screw length (mm)	Max. fixing thickness (mm)	Pack (pcs.)	Code
ENP/OC 9x40	9	55	40	M4	43	-	100	8700011
ENP/OC 9x50	9	65	50	M4	57	-	100	8700041
ENP/OC 12x45	12	60	45	M5	46	-	50	8700030
ENP/OC 12x55	12	70	55	M5	60	-	50	8700045
ENP/OC 9x40 blister	9	55	40	M4	43	-	6	565431
ENP/OC 12x45 blister	12	60	45	M5	46	-	4	565437

ENP/DD ROD AND DOUBLE NUT



Description	Ø drilling (mm)	Drilling depth (mm)	Anchor length (mm)	Ø rebar (mm)	Screw length (mm)	Max. fixing thickness (mm)	Pack (pcs.)	Code
ENP/DD 9x40	9	55	40	M4	78	-	100	8700013
ENP/DD 12x45	12	60	45	M5	85	-	50	8700032
ENP/DD 9x40 blister	9	55	40	M4	78	-	6	565432

ENP/FP DOORSTOP



Description	Ø drilling (mm)	Drilling depth (mm)	Anchor length (mm)	Ø rebar (mm)	Screw length (mm)	Max. fixing thickness (mm)	Pack (pcs.)	Code
ENP/FP 9x40 white	9	55	40	M4	60	-	50	8700039
ENP/FP 9x40 black	9	55	40	M4	60	-	50	8700040
ENP/FP 9x40 white blister	9	55	40	M4	60	-	2	565991
ENP/FP 9x40 black blister	9	55	40	M4	60	-	2	565992

XTECH

THE BEST ON PLASTERBOARD, SHEETS, AND PERFORATED MATERIALS

NO LAYING TOOL

XTECH is installed with a simple screwdriver: **screwing is easy** and progressive until the fixing complete stop.

VERSATILE

The range includes assembly with **metric cylindrical head screws, countersunk head screws, eyelets**, and hooks: they can solve different application needs both for professionals and hobbyists.

NO ROTATION

Robust and effective fins block any plug rotation during installation on drywall and lightweight materials.

SPECIAL LIP

The **inner lip** blocks the knotting, **safeguarding the panel structure**.

MAXIMUM FLEXIBILITY

The geometry with **8 helicoidal cuts** and the **body material** allow a **perfect knotting** with great resistance in hollow base materials and in the cavities of various support materials.

BI-MATERIAL STRUCTURE

The special constructive technology allows to **combine the characteristics of the two different materials** constituting the body and the tip.

HIGHEST RESISTANCE

The plug tip has an **M5 metric thread** and is made of very **high-strength polymer**: this allows the use of metric screws and accessories for high-capacity anchors.

T61

Light-duty steel anchor especially recommended for solid base materials



Base materials



Applications

- Shelves, cabinets, furniture
- Curtain rails
- Lighting
- Lightweight racks
- Lightweight suspensions
- Heaters, fans, radiators
- Metal support brackets
- Electrical panels, fuse boxes

Features and benefits

- Steel structure anchor
- Expansion to three independent sectors for high loads on compact materials

Installation

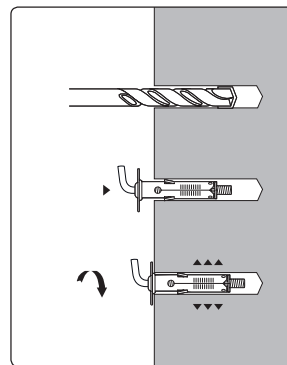

Technical data

Anchor and accessories material: electrolytic zinc plated steel

Application conditions in mm		Recommended tensile loads - Nrec in kN (1kN ~ 100 Kg)	Access breakage in kN (1 kN ~ 100 Kg)*
Ø	Ø drilling	Non-cracked concrete C20/25	
6	6	0,40	0,26
8	8	0,46	0,36
9	9	0,56	0,40

* Accessories range representative value
Consult the technical documentation and check or take various adequate safety factors as applicable.

T61/DB FRAME ANCHOR WITH COUNTERSUNK PAN HEAD SCREW - POZIDRIV



Description	Ø drilling (mm)	Drilling depth (mm)	Anchor length (mm)	Ø rebar (mm)	Screw length (mm)	Max. fixing thickness (mm)	Pack (pcs.)	Code
T61/DB 9x80 M5	9	45	80	M5	80	45	100	569544
T61/DB 10x80 M6	10	45	80	M6	80	45	100	569545

T61/V COUNTERSUNK PAN HEAD SCREW - POZIDRIV



Description	Ø drilling (mm)	Drilling depth (mm)	Anchor length (mm)	Ø rebar (mm)	Screw length (mm)	Max. fixing thickness (mm)	Pack (pcs.)	Code
T61/V 6x25	6	35	25	M3	30	5	100	8712047
T61/V 8x35	8	50	35	M4	40	5	100	8712050
T61/VP 8x35	8	50	35	M4	52	10	100	8712051
T61/V 9x40	9	55	40	M5	45	5	100	8712052
T61/VP 9x40	9	55	40	M5	55	10	100	8712053
T61/VP 9x40 blister	9	55	40	M5	45	5	4	565438

T61/GC SHORT HOOK



Description	Ø drilling (mm)	Drilling depth (mm)	Anchor length (mm)	Ø rebar (mm)	Screw length (mm)	Max. fixing thickness (mm)	Pack (pcs.)	Code
T61/GC 6x25	6	35	25	M3	42	3	100	8712048
T61/GC 8x35	8	50	35	M4	43	4	100	8712054
T61/GC 9x40	9	55	40	M5	46	4,5	100	8712055
T61/GC 9x40 blister	9	55	40	M5	46	4,5	4	565439

T61/GM MEDIUM HOOK



Description	Ø drilling (mm)	Drilling depth (mm)	Anchor length (mm)	Ø rebar (mm)	Screw length (mm)	Max. fixing thickness (mm)	Pack (pcs.)	Code
T61/GM 8x35	8	50	35	M4	43	10	100	8712056
T61/GM 9x40	9	55	40	M5	46	10	100	8712057
T61/GM 9x40	9	55	40	M5	46	10	4	565440

T61/OA EYE HOOK



Description	Ø drilling (mm)	Drilling depth (mm)	Anchor length (mm)	Ø rebar (mm)	Screw length (mm)	Max. fixing thickness (mm)	Pack (pcs.)	Code
T61/OA 8x35	8	50	35	M4	43	17	100	8712060
T61/OA 9x40	9	55	40	M5	46	19	100	8712061
T61/OA 9x40 blister	9	55	40	M5	46	19	4	565441

T61/OC CLOSED EYE HOOK



Description	Ø drilling (mm)	Drilling depth (mm)	Anchor length (mm)	Ø rebar (mm)	Screw length (mm)	Max. fixing thickness (mm)	Pack (pcs.)	Code
T61/OC 6x25	6	35	25	M3	42	6	100	8712049
T61/OC 8x35	8	50	35	M4	43	13	100	8712062
T61/OC 9x40	9	55	40	M5	46	13	100	8712063
T61/OC 9x40 blister	9	55	40	M5	46	13	4	565442

T61/DD ROD AND DOUBLE NUT



Description	Ø drilling (mm)	Drilling depth (mm)	Anchor length (mm)	Ø rebar (mm)	Screw length (mm)	Max. fixing thickness (mm)	Pack (pcs.)	Code
T61/DD 8x35 M4	8	50	35	M4	70	30	100	8712064
T61/DD 9x40 M5	9	55	40	M5	80	25	50	8712065
T61/DD 9x40 M6	9	55	40	M6	70	20	50	8712066

XTECH

High performance anchor for plasterboard and hollow blocks



Base materials



Features and benefits

- Quick, very effective, high resistance fastening
- It knots in the inside of drywall or hollow blocks
- Always reliable thanks to the reinforced polymer cone
- Metric thread allows fine tightening adjustment so good clamping of the part to be fixed and onto the wall
- 50 mm length variant is especially recommended for fastening on single layer plasterboard. 60 mm length variant fits either for double layer plasterboard or fastenings on hollow blocks
- Can be installed both with electric or manual screwdrivers

Installation

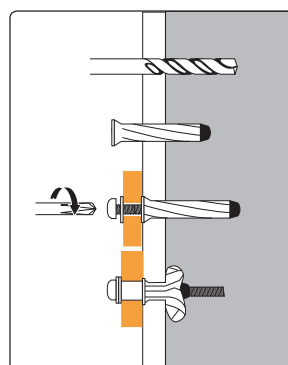

Applications

- Radiators
- Bathroom fixtures
- Curtain rails, hangers
- Lighting
- Support brackets
- Mantles

Technical data

Anchor material	polyamide + tecnopolymer
Product material viti e accessori	electrolytic zinc plated steel

Ø	Application conditions in mm		Recommended tensile loads - Nrec in kN (1kN ~ 100 Kg)				Access breakage in kN (1 kN ~ 100 Kg)*
	Ø drilling		Concrete hollow block	Unrendered hollow brick	Plasterboard (13 mm)	Plasterboard (13 + 13 mm)	
10	10		0,30	0,30	0,18	0,22	0,35

* Accessories range representative value
Consult the technical documentation and check or take various adequate safety factors as applicable.

XTECH



Description	Ø drilling (mm)	Drilling depth (mm)	Anchor length (mm)	Screw length (mm)	Ø screw (mm)	Max. fixing thickness (mm)	Pack (pcs.)	Code
XTECH 10x50 with pan head screw	10	55	50	55	M5	15	100	565892
XTECH 10x60 with pan head screw	10	65	60	65	M5	15	100	565898
XTECH 10x50 with hook	10	55	50	46	M5	-	100	565894
XTECH 10x50 with eye hook	10	55	50	46	M5	-	100	565895
XTECH 10x50 with eye hook	10	55	50	46	M5	-	100	565896

EMS

Universal floating shelf brackets



Base materials



Features and benefits

- Special anchoring system performing both on compact materials, such as concrete and bricks, and hollow base materials
- Easy and safe installation, supports high loads in different conditions
- Excellent aesthetic finish: no bracket or support visible under the shelves

Applications

- Wooden shelves and wall units

Installation

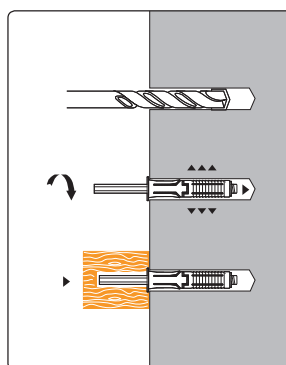

Technical data

Anchor material	polyamide 6 + steel cone
Shelf material	zinc plated steel



EMS

Description	Ø drilling (mm)	Drilling depth (mm)	Anchor length (mm)	Ø drill on the object (mm)	Rebar overhang (mm)	Exagonal wrench	Pack (pcs.)	Code
EMS 12.9.70	12	80	70	9	70	8	50	8719101
EMS 12.9.100	12	80	70	9	100	8	50	8719102
EMS 12.9.120	12	80	70	9	120	8	50	8719103
EMS 12.9.140	12	80	70	9	140	8	50	8719104
EMS 12.12.100	12	80	70	12	100	10	20	8719105
EMS 12.12.120	12	80	70	12	120	10	20	8719106
EMS 12.12.140	12	80	70	12	140	10	20	8719107
EMS 14.14.120	14	90	75	14	120	13	20	8719108
EMS 14.14.145	14	90	75	14	145	13	20	8719109
EMS 14.14.170	14	90	75	14	170	13	20	8719110
EMS 12.9.70 blister	12	80	70	9	70	8	2	566054
EMS 12.9.100 blister	12	80	70	9	100	8	2	565475
EMS 12.9.120 blister	12	80	70	9	120	8	2	566056
EMS 12.9.140 blister	12	80	70	9	140	8	2	566057
EMS 12.12.100 blister	12	80	70	12	100	10	2	565477
EMS 12.12.140 blister	12	80	70	12	140	10	2	565476
EMS 14.14.120 blister	14	90	75	14	120	13	2	565478
EMS 14.14.145 blister	14	90	75	14	145	13	2	565479
EMS 14.14.170 blister	14	90	75	14	170	13	2	565480
EM 12 blister replacement	12	80	70	-	-	-	4	565481
EM 14 blister replacement	14	90	75	-	-	-	4	565482

T-CLICK

Self-drilling high performance expansion anchor in reinforced polyamide for plasterboard and aerated concrete

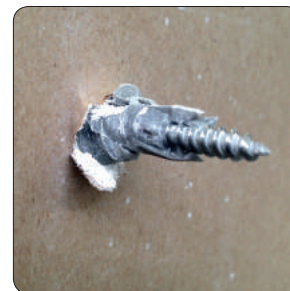

Base materials



*pre-drilling Ø 8 mm

Features and benefits

- Fast solution without pre-drilling, for plasterboard up to 15 mm thickness
- Additional expansion ensures high tensile and shear resistance
- Ideal flush finishing
- Suitable also for aerated concrete (8 mm pre-drilling required)

Installation

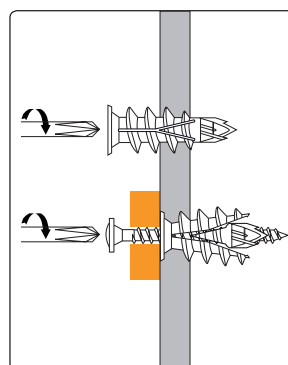

Applications

- Clamps, clips for tubes or pipes for HVAC or electrical installations
- Plastic or metal trunkings
- Lighting
- Shelves, lightweight cabinets
- Bathroom fixtures

Technical data

Anchor material	reinforced polyamide with fiberglass
Screw material	electrolytic zinc plated steel

Application conditions in mm	Recommended tensile loads - Nrec in kN (1kN ~ 100 Kg)		Recommended tensile loads - Nrec in kN (1kN ~ 100 Kg)
Self-drilling. For aerated concrete, drill:	Aerated concrete	Plasterboard (13 mm)	Plasterboard (13 mm)
Ø 8x45	0,1	0,09	0,25

Consult the technical documentation and check or take various adequate safety factors as applicable.

T-CLICK PAN HEAD SCREW - POZIDRIV



Description	Anchor length (mm)	Ø screw (mm)	Screw length (mm)	Max. fixing thickness (mm)	Pack (pcs.)	Code
T-CLICK TP 10	40	4,5	45	10	25	566261
T-CLICK TP 10	40	4,5	45	10	100	566301
T-CLICK TP 10 <i>blister</i>	40	4,5	45	10	4	566023

DRIVA

Self-drilling zinc-aluminium alloy anchor for plasterboard and aerated concrete

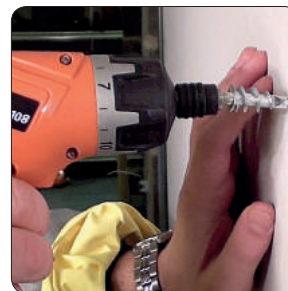
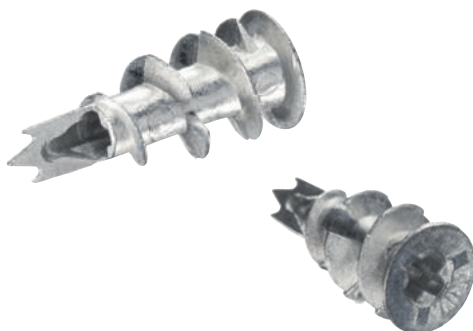

Base materials



*pre-drilling Ø 8 mm

Features and benefits

- Fast solution without pre-drilling, for plasterboard or aerated concrete
- Available either with pan or countersunk head to fit different fastening requirements
- Corrosion resistant, thanks to the zinc-aluminium alloy body
- Specific geometry for effective anchoring on single and coupled lightweight panels
- Thin blade thread and smooth edge: prevents gypsum swelling and paper tearing

Applications

- Clamps, clips, brackets for tubes, pipes for HVAC or electrical installations
- Plastic or metal trunkings
- Switchboxes
- Lighting
- Lightweight cabinets
- Signs

Installation

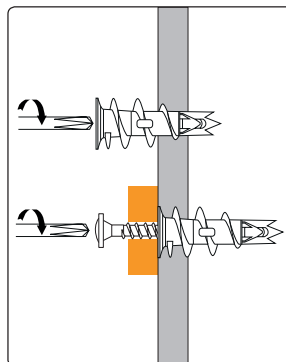

Technical data

Anchor material	zinc-aluminium alloy
Screw material	electrolytic zinc plated steel

Application conditions in mm	Recommended tensile loads - Nrec in kN (1kN ~ 100 Kg)	
Self-drilling. For aerated concrete, drill.	Aerated concrete	Plasterboard (13 mm)
Ø 8x35	0,06	0,06

Consult the technical documentation and check or take various adequate safety factors as applicable.

DRIVA ZINC PLATED COUNTERSUNK FLAT/PAN HEAD SCREWS - POZIDRIV



Description	Anchor length (mm)	Ø screw (mm)	Screw length (mm)	Max. fixing thickness (mm)	Pack (pcs.)	Code
DRIVA TP 12	31	4,5	35	12	100	569443
DRIVA TF 5	31	4,5	25	5	100	569444
DRIVA TF 27	31	4,5	50	27	100	569445
DRIVA TP 12 blister	31	4,5	35	12	4	565464
DRIVA TP 12 can	31	4,5	35	12	150	568144

* TP = pan head, TF = countersunk head

For applications on aerated concrete, a pre-drilling of ø 6 mm is required. For applications on coupled gypsum sheets and gypsum blocks a pre-drilling of ø 10 mm is required.

DRIVA NYLON

Self-drilling plastic anchor for plasterboard and aerated concrete



Base materials



Features and benefits

- Fast solution without pre-drilling, for plasterboard or aerated concrete
- Flanged head screw fits fastening of thin or plastic parts
- White colour provides good external appearance

Applications

- Clips for tubes, pipes for HVAC or electrical installations
- Plastic or metal trunkings
- Switchboxes
- Lighting
- Signs
- Picture frames

Installation

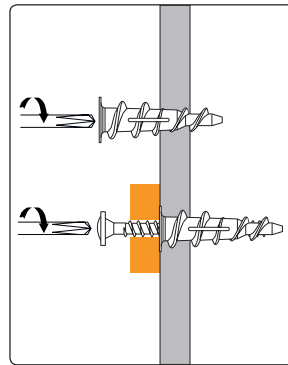

Technical data

Anchor material	reinforced polyamide
Screw material	electrolytic zinc plated steel

Application conditions in mm	Recommended tensile loads - Nrec in kN (1kN ~ 100 Kg)	
Self-drilling. For aerated concrete, drill	Aerated concrete	Plasterboard (13 mm)
Ø 5x35	0,05	0,04

Consult the technical documentation and check or take various adequate safety factors as applicable.

DRIVA NYLON PAN HEAD SCREW - POZIDRIV



Description	Anchor length (mm)	Ø screw (mm)	Screw length (mm)	Max. fixing thickness (mm)	Pack pcs.	Code
DRIVA NYLON TP12	30	3	25	12	200	569442
DRIVA NYLON TP12 blister	30	3	25	12	10	565463

MINI DRIVA

Self-drilling anchor, all-in-one solution, for lightweight fastening in plasterboard, gypsum fiber board, and areated concrete



Base materials



Features and benefits

- Extremely fast, single step solution
- Direct mounting without pre-drilling
- Corrosion resistant, thanks to the zinc-aluminium alloy body

Applications

- Plastic trunkings, raceways
- Plastic clips

Installation

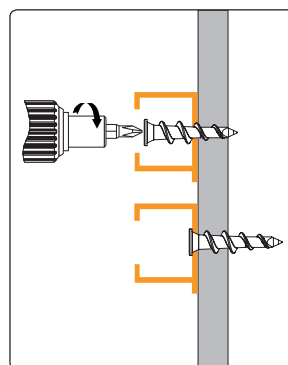

Technical data

Anchor material zinc-aluminum alloy (zamak)

Application conditions in mm	Recommended tensile loads - Nrec in kN (1kN ~ 100 Kg)	
Self drilling	Aerated concrete	Plasterboard (13 mm)
-	0,03	0,03

Consult the technical documentation and check or take various adequate safety factors as applicable.

MINI DRIVA



Description	Anchor length (mm)	Max. fixing thickness (mm)	Pack (pcs.)	Code
Mini Driva	26	5	200	565398

ETPV ZENTECH

Zinc coated steel anchor for boards or hollow blocks



Base materials



Features and benefits

- Using the special tool, the anchor sleeve bends, expand and grip against the inside of the drywall
- The undercut principle allows high resistance even on thin walls or lightweight panels
- Fixed part can be removed and repositioned without damaging the anchor

Applications

- Radiators
- Curtain rails, hangers
- Bathroom fixtures
- Lighting
- Pipe clips
- Mantles

Installation

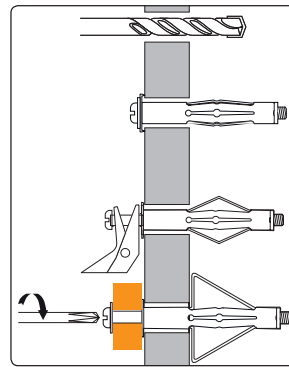

Installation tool



cod. 707070

Technical data

Anchor and accessories material electrolytic zinc plated steel

Application conditions in mm		Recommended tensile loads - Nrec in kN (1kN ~ 100 Kg)		
Ø	Ø drilling	Concrete hollow block	Unrendered hollow brick	Plasterboard (13 mm)
M4	8	0,20	0,20	0,20
M5	10	0,20	0,20	0,20
M6	12	0,20	0,20	0,20

Consult the technical documentation and check or take various adequate safety factors as applicable.

ETPV-ZENTECH PAN HEAD METRIC SCREW - POZIDRIV



Description	Ø drilling (mm)	Plate thickness (mm)	Anchor length (mm)	Ø screw (mm)	Screw length (mm)	Pack (pcs.)	Code
ETPV/V ZENTECH M4/8X34-40	8	13-18	34	M4	40	50	569546
ETPV/V M4/8x35-41	8	5+9	35	M4	41	100	568617
ETPV/V M4/8x40-47	8	10+16	40	M4	47	100	568618
ETPV/V ZENTECH M5/10X34-40	8	13-18	35	M5	40	50	569547
ETPV/V M5/10x50-59	10	11+16	50	M5	59	50	568621
ETPV/V M5/10x63-72	10	21+27	63	M5	72	50	568622
ETPV/V ZENTECH M6/12X35-40	10	13-18	35	M6	40	50	569548

ETAF

Zinc coated toggle anchor suitable for boards and hollow blocks, for wall or overhead applications

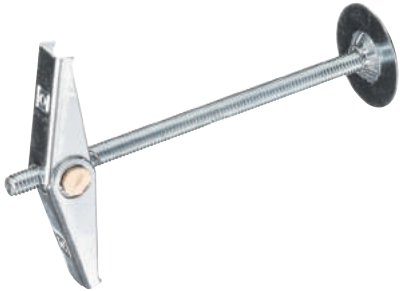

Base materials



Features and benefits

- Intrinsically safe anchor, for drywall and especially overhead installation
- High quality components in zinc coated steel

Applications

- Lightweight suspensions
- Ceiling lights
- Curtain rails
- Lightweight cabinets
- Heaters, radiators
- Electrical panels, fuse boxes

Installation

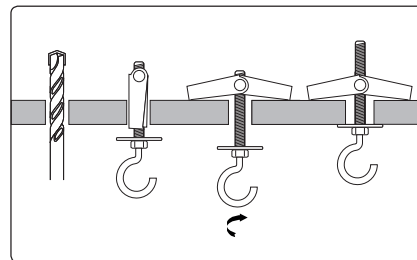

Technical data

Anchor and accessories material electrolytic zinc plated steel

Ø	Application conditions in mm	Recommended tensile loads - Nrec in kN (1kN ~ 100 Kg)		Access breakage in kN (1 kN ~ 100 Kg)*
		Concrete hollow block	Unrendered hollow brick	
M4/12	Ø drilling 12	0,30	0,30	0,35
M4/14	14	0,37	0,30	0,35
M5/14	14	0,37	0,30	0,40

* Accessories range representative value
Consult the technical documentation and check or take various adequate safety factors as applicable.

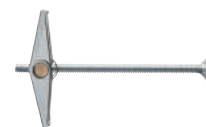

ETAFA/V COUNTERSUNK PAN HEAD SCREW - POZIDRIV

Description	Ø drilling (mm)	Drilling depth (mm)	Thread length (mm)	Ø screw (mm)	Max. fixing thickness (mm)	Pack (pcs.)	Code
ETAFA/V 4/12	12	80	75	M4	45	50	8706001
ETAFA/V 4/14	14	80	75	M4	40	50	8706002
ETAFA/V 5/14	14	80	75	M5	45	50	569540
ETAFA/V 4/12 <i>blister</i>	12	80	75	M4	45	2	566006
ETAFA/V 4/14 <i>blister</i>	14	80	75	M4	40	2	565459



ETAFA/DC ROD AND CUP NUT

Description	Ø drilling (mm)	Drilling depth (mm)	Thread length (mm)	Ø screw (mm)	Max. fixing thickness (mm)	Pack (pcs.)	Code
ETAFA/DC 4/12	12	100	95	M4	55	50	8706351
ETAFA/DC 4/14	14	100	95	M4	50	50	8706352
ETAFA/DC 4/14 <i>blister</i>	14	100	95	M4	50	2	565460

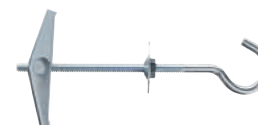

ETAFA/OA EYE HOOK

Description	Ø drilling (mm)	Drilling depth (mm)	Thread length (mm)	Ø screw (mm)	Max. fixing thickness (mm)	Pack (pcs.)	Code
ETAFA/OA 4/12	12	100	65	M4	-	50	8706201
ETAFA/OA 4/14	14	100	65	M4	-	50	8706202
ETAFA/OA 5/14	14	100	65	M5	-	50	569541
ETAFA/OA 4/12 <i>blister</i>	12	100	65	M4	-	2	566005
ETAFA/OA 4/14 <i>blister</i>	14	100	65	M4	-	2	565461



ETAFA/OC CLOSED EYE HOOK

Description	Ø drilling (mm)	Drilling depth (mm)	Thread length (mm)	Ø screw (mm)	Max. fixing thickness (mm)	Pack (pcs.)	Code
ETAFA/OC 4/12	12	70	65	M4	-	50	8706101
ETAFA/OC 4/14	14	70	65	M4	-	50	8706102
ETAFA/OC 5/14	14	70	65	M5	-	50	569542
ETAFA/OC 4/12 <i>blister</i>	12	70	65	M4	-	2	566004



ETAFA/DD ROD AND DOUBLE NUT

Description	Ø drilling (mm)	Drilling depth (mm)	Thread length (mm)	Ø screw (mm)	Max. fixing thickness (mm)	Pack (pcs.)	Code
ETAFA/DD 4/12	12	100	95	M4	15	50	8706301
ETAFA/DD 4/14	14	100	95	M4	15	50	8706302
ETAFA/DD 4/12 <i>blister</i>	12	100	95	M4	15	2	566003

ETR

High load zinc coated toggle anchor suitable for boards and hollow blocks, for wall or overhead applications

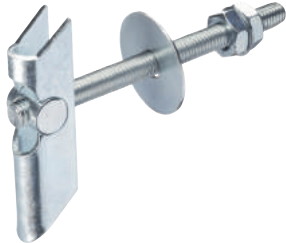

Base materials



Features and benefits

- Intrinsically high load safe anchor, for drywall and especially overhead installation
- All components in zinc coated steel

Applications

- Air ducts
- Ceiling lights
- Suspended ceilings
- Heaters, radiators

Installation

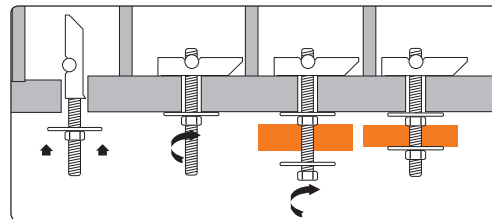

Technical data

Anchor and accessories material electrolytic zinc plated steel

Application conditions in mm		Recommended tensile loads - Nrec in kN (1kN ~ 100 Kg)	Access breakage in kN (1 kN ~ 100 Kg)*
Ø	Ø drilling	Unrendered hollow brick	
M6	16	0,72	0,40
M8	20	1,20	0,60

* Accessories range representative value
Consult the technical documentation and check or take various adequate safety factors as applicable.

ETR/DD ROD AND DOUBLE NUT



Description	Ø drilling (mm)	Drilling depth (mm)	Ø screw (mm)	Thread length (mm)	Pack (pcs.)	Code
ETR/DD 6	16	105	M6	100	25	8706303
ETR/DD 8	20	105	M8	100	25	8706304

ETR/OA EYE HOOK



Description	Ø drilling (mm)	Drilling depth (mm)	Ø screw (mm)	Eyehook thread length (mm)	Pack (pcs.)	Code
ETR/OA 6	16	105	M6	100	25	8706203
ETR/OA 8	20	105	M8	100	25	8706204

ETNF

Light-duty plastic toggle anchor, for plasterboard and thin boards

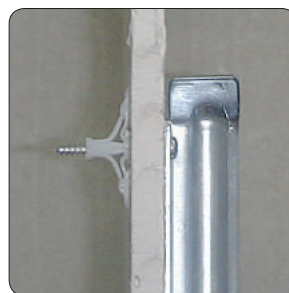

Base materials



Features and benefits

- Very versatile for light-duty fastenings
- Suitable for wide range of screw types and size
- Manufactured with premium quality high strength polyamide

Applications

- Lighting
- Picture frames
- Signs

Installation

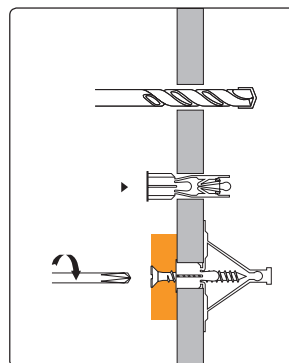

Technical data

Anchor material polyamide

Ø	Application conditions in mm		Recommended tensile loads - Nrec in kN (1kN ~ 100 Kg)			
	Ø drilling	Screw	Drilling depth	Plasterboard (10 mm)	Plasterboard (13 mm)	Plasterboard (13+13 mm)
10	10	4,5x50	40	0,05	0,05	-
10	10	4,5x60	50	-	-	0,05

Consult the technical documentation and check or take various adequate safety factors as applicable.

ETNF NYLON TOGGLE



Description	Ø drilling (mm)	Drilling depth (mm)	Anchor length (mm)	Ø screw (mm)	Min. screw length (mm)	Max. fixing thickness (mm)	Pack (pcs.)	Code
ETNF 10x38	10	40	38	4 ÷ 4,5	50	-	100	8711000
ETNF 10x47	10	50	47	4 ÷ 4,5	60	-	100	8711001

EIS-D

Spiral anchor for fastening on ETICS façades and low or medium density insulation panels



Base materials

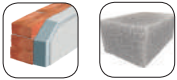

Features and benefits

- Self-drilling anchor in reinforced polyamide designed for fixing on composite insulation systems
- No thermal bridge
- Short length fits also shallow thickness insulation
- Effective performance on medium or high density panels
- EIS-D is particularly suitable for fixing on medium density insulation. EIS-D LT is suitable for fixing on low-density insulation
- EIS-D 95 is particularly suitable for fixing pipe collars

Installation

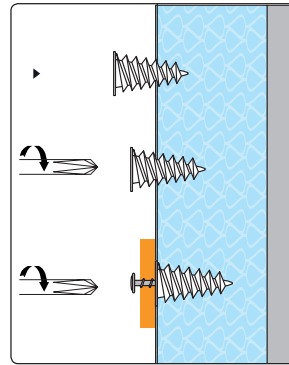

Applications

- Cameras
- Detectors, sensors and alarms
- Switchboxes
- Clamps, clips, brackets for tubes or pipes
- Signs
- Mailboxes

Technical data

Anchor material	reinforced polyamide
Screw material	electrolytic zinc plated steel

EIS-D AND EIS-D LT

Application conditions in mm	Recommended tensile loads - Nrec in kN (1kN ~ 100 Kg)	
Self-drilling. With thick plaster; drilling diameter:	polyester cl. EPS 80	polyester cl. EPS 100
8x50	0,035	0,05

EIS-D 95

Application conditions in mm	Recommended tensile loads - Nrec in kN (1kN ~ 100 Kg)	
Self-drilling. With thick plaster; drilling diameter:	polyester cl. EPS 80	polyester cl. EPS 100
8x95	0,05	0,065

Consult the technical documentation and check or take various adequate safety factors as applicable.

EIS-D PLUG - TORX



Description	Ø drilling (mm)	Anchor length (mm)	Screw length (mm)	Ø screw (mm)	Insulation thickness (mm)	Pack (pcs.)	Code
EIS-D 24x50	-	50	>35	4 ÷ 4,5	≥ 55	50	568176

EIS-D/V PAN HEAD SCREW - PHILIPS



Description	Ø drilling (mm)	Anchor length (mm)	Screw dimension (mm)	Max. fixing thickness (mm)	Insulation thickness (mm)	Pack (pcs.)	Code
EIS-D/V 24x50	-	50	4,5x45	5	≥ 55	50	568177

EIS-D LT PLUG - HEX HEAD



Description	Ø drilling (mm)	Anchor length (mm)	Screw length (mm)	Ø screw (mm)	Insulation thickness (mm)	Pack (pcs.)	Code
EIS-D LT 28X50	-	50	>35	4 ÷ 4,5	≥ 55	50	568174

EIS-D LT/V PAN HEAD SCREW - PHILIPS



Description	Ø drilling (mm)	Anchor length (mm)	Screw dimension (mm)	Max. fixing thickness (mm)	Insulation thickness (mm)	Pack (pcs.)	Code
EIS-D LT/V 28X50	-	50	4,5x45	5	≥ 55	50	568175

EIS-D 95 PLUG - HEX HEAD



Description	Ø drilling (mm)	Anchor length (mm)	Screw length (mm)	Ø screw (mm)	Insulation thickness (mm)	Pack (pcs.)	Code
EIS-D 95 30X95	-	95	>60	8 ÷ M8	≥ 100	50	568176

ECLIP

Accessory for rigid conduits clamping in the diameter range 16÷50 mm



Features and benefits

- Angled and rounded edges makes tube clamping quick and easy
- Slotted hole allows adjusting for easy alignment
- Interlocking slots for the support rails
- Dovetail profiles for side-by-side mounting
- Suitable for T6, UCX, E plugs

Technical data

product material:	polypropylene, color gray RAL 7035
Installation temperature:	-5° ÷ +35°C
Working temperature:	-30 ÷ +55°C
Flammability Rating:	HB according to UL 94
Glow wire test:	650°C according to IEC 60695-2-12
Maximum strength to release:	up to 9 daN

Installation

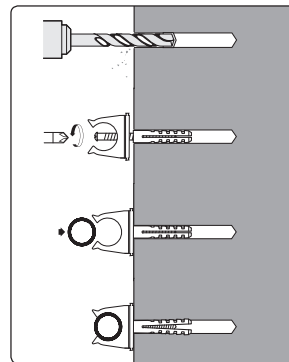

ECLIP

Description	Internal ø (mm)	Resistance to unhooking (daN)	Pack (pcs.)	Code
ECLIP 16	15	6	100	13502116
ECLIP 20	19	7	100	13502120
ECLIP 25	24	6	100	13502125
ECLIP 32	30	9	50	13502132
ECLIP 40	38	7	50	13502140
ECLIP 50	48	7	20	13502150
ECLIP/1 16 industrial	15	6	4.000	13502016
ECLIP/1 20 industrial	19	7	3.000	13502020
ECLIP/1 25 industrial	24	6	2.200	13502025
ECLIP/1 32 industrial	30	9	1.700	13502032
ECLIP/1 40 industrial	38	7	1.200	13502040
ECLIP/1 50 industrial	48	7	900	13502050

CT-CLIP

Accessory for cable management, suitable for conduits or apparent cables in the diameter range 16÷63 mm



Features and benefits

- Convenient slotted hole allows mounting with various types of plastic plugs
- Range adapted to all common diameters of rigid conduits for electrical installations

Installation

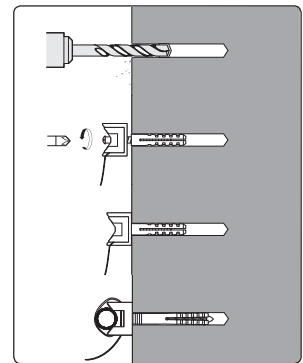

Technical data

Product material:	polyamide 6.6, color gray RAL 7035
Installation temperature:	-5°C ÷ 35°C
Working temperature:	-40°C ÷ +70°C
Flammability Rating:	HB according to UL 94
Glow wire test:	650 °C according to IEC 60695-2-12
Min. Tensile strength:	360 N

Approvals and certifications

Compliant with CEI EN 62275 - cable trays systems and accessories for cables - Cable ties for electrical installations

CT-CLIP

Description	Total length (mm)	Ø bundle min/max	Base width (mm)	Base length (mm)	Tensile Strength (N)	Pack (pcs.)	Code
CT-CLIP 16-32	180	16 ÷ 32	16	24,5	360	100	565510
CT-CLIP 40-63	280	40 ÷ 63	16	40,5	360	100	565511

ELEFIX

Accessory for cable management, suitable for conduits or apparent cables in the diameter range 16÷63 mm. With metric threaded hole M6/7

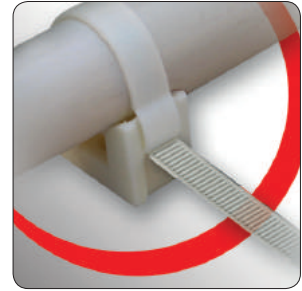

Features and benefits

- The metric threaded hole M6/7 allows assembling with various types of plastic plugs in all masonry types
- The accessory can be mounted with threaded stud plugs, such as UCX/VM or the special ELEFIX anchor

Technical data

Product material:	polyamide 6.6, color gray RAL 7035
Installation temperature:	-15° ÷ +35°C
Working temperature:	-40 ÷ +85°C
Flammability Rating:	V2 according to UL 94
Glow wire test:	850°C according to IEC 60695-2-12
Min. Tensile strength:	360 N

Approvals and certifications

Compliant with CEI EN 62275 - cable trays systems and accessories for cables - Cable ties for electrical installations

Installation

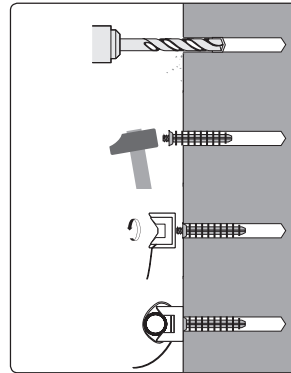

Installation with ELEFIX M7 anchor

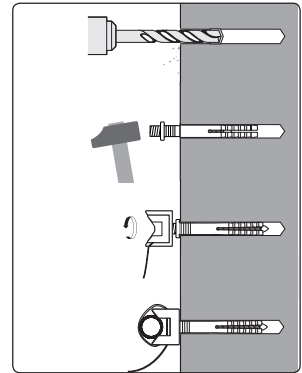

Installation with UCX V M6 anchor

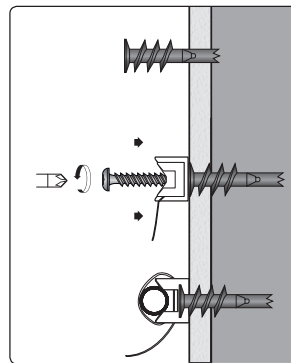

Installation with drive anchor

ELEFIX

Description	Total length (mm)	Ø bundle min/max	Base width (mm)	Base length (mm)	Tensile Strength (N)	Pack (pcs.)	Code
ELEFIX 16-32	180	16 ÷ 32	16	24,5	360	100	565958
ELEFIX 40-63	280	40 ÷ 63	16	40,5	360	100	565961

ELEFIX M7 ANCHOR



Description	Ø hole (mm)	Thread	Length (mm)	Pack (pcs.)	Code
ELEFIX threaded M7/Øx37	8	M7	37	100	565940

M6 UCX/VM ANCHOR



Description	Ø drilling (mm)	Drilling depth (mm)	Anchor length (mm)	Embedment depth (mm)	Ø lip (mm)	Metric screw (mm)	Pack (pcs.)	Code
UCX/VM M6/Øx35	6	45	35	35	10	M6x10	100	8710014

ECAV

Accessory for rigid conduits with plastic cover, especially designed for overhead in the diameter range 4÷60 mm



Features and benefits

- Strong interlock between the saddle and the cap highly resistant clamping
- Internal centering lids for tube alignment preventing tube sliding
- Dovetail profiles for side-by-side mounting
- Range adapted to all common diameters of rigid conduits for electrical installations
- Slotted hole allows adjusting for easy alignment Suitable for T6, UCX, E plugs

Installation

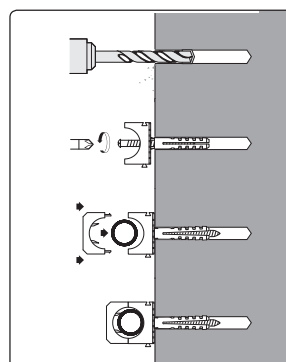

Technical data

Product material:	polyamide 6, color gray RAL 7035
Installation temperature:	-5° ÷ +40°C
Working temperature:	-30 ÷ +65°C
Flammability Rating:	HB according to UL 94
Glow wire test:	650°C according to IEC 60695-2-12
Maximum strength to release:	up to 50 daN

ECAV

Description	Tube ø min. (mm)	Tube ø max (mm)	Resistance to unhooking (daN)	Pack (pcs.)	Code
ECAV 8	4	8	10	200	13501008
ECAV 12	8	12	10	100	13501012
ECAV 16	12	16	23	75	13501016
ECAV 20	16	23	20	50	13501020
ECAV 25	20	25	25	50	13501025
ECAV 32	25	32	31	25	13501032
ECAV 40	32	40	40	20	13501040
ECAV 50	40	60	50	15	13501050

S-CLIP

Light-duty, hammer-in fastening plug for simple and time-saving fixing of conduits or flexible pipes



Materials



Features & Benefits

- One piece fastening for a quick and easy one-hand installation
- Exclusive anchoring design guarantees high load-bearing capacity in different materials

Application

- Fixing conduits and pipes for both Electrician and Plumbers applications
- Apparent and temporary fastening
- Rigid pipes
- Semi-rigid electrical conduits
- Corrugated electrical conduits
- Gas, water and heating pipes

Installation

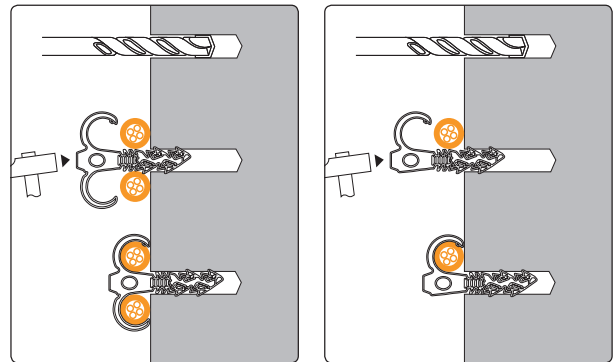

Technical Data

Material:	polyamide 6 grey colour RAL 7035
Installation temperature:	0° ÷ +40°C
Working temperature:	-20 ÷ +80°C
Flammability rating:	HB according UL 94
Glow wire test:	650°C according IEC 60695-2-12

Ø	Application condition mm		Recommended tensile loads - Nrec in kN (1kN ~ 100 Kg)				
	Ø drilling	Drilling depth	Concrete (C20/25)	Solid brick	Concrete hollow block	Hollow brick	Aerated concrete
S-CLIP all size	8	≥40	13	10	8	7	5

Indicative recommended loads for single anchor. Consult the technical documentation for the correct fixing sizing



S-CLIP

Description	Clamping range (mm)	Anchoring depth (mm)	Drilling depth (mm)	Ø drilling (mm)	Pack (pcs.)	Code
SINGLE VERSION						
S-CLIP S can	16-20	35	≥40	8	100	569485
S-CLIP S can	20-25	35	≥40	8	100	569486
S-CLIP S can	25-28	35	≥40	8	100	569487
DOUBLE VERSION						
S-CLIP D can	16-20	35	≥40	8	100	569488
S-CLIP D can	20-25	35	≥40	8	100	569489
S-CLIP D can	25-28	35	≥40	8	100	569490

Clamps M6

Zinc-plated steel clamps for lightweight pipeworks with screws and M6 metric threaded connector



Features and benefits

- Easy connection with M6 metric threaded stud nails or plugs, such as UCX/VM 6

Applications

- Metal or plastic pipeworks mountings, with rigid or semi-rigid pipes

Technical data

Clamp material: electrolytic zinc plated steel



STEEL CLAMP M6

Description	Ø min. internal (mm)	Ø max internal (mm)	Pack (pcs.)	Code
Steel clamp M6 - 16 ZG	16	17	100	8730223
Steel clamp M6 - 18 ZG	18	19	100	8730224
Steel clamp M6 - 20 ZG	19	20	100	8730225
Steel clamp M6 - 22 ZG	21	22	100	8730226
Steel clamp M6 - 24 ZG	24	26	100	8730227
Steel clamp M6 - 26 ZG	25	26	100	8730228
Steel clamp M6 - 32 ZG	31	32	100	8730229
Steel clamp M6 - 40 ZG	38	40	25	8730230

UCX/VM

STEEL CLAMP M6 WITH ISO METRIC HEAD SCREW



Description	Ø drilling (mm)	Drilling depth (mm)	Min. embedment depth (mm)	Anchor length (mm)	Ø lip (mm)	Metric screw (mm)	Pack (pcs.)	Code
UCX/VM 6 - 6x35	6	45	35	35	10	M6	100	8710014

E/CL

Clamping system for pipeworks in sanitary and drainage installations



Base materials



Features and benefits

- Strong galvanized steel clamp, supplied with double threaded rod and E type polyamide universal plug
- Increased width and thickness, welded nut

Applications

- Heavy weight metal pipes mounting
- Large diameter plastic pipes installation



Installation

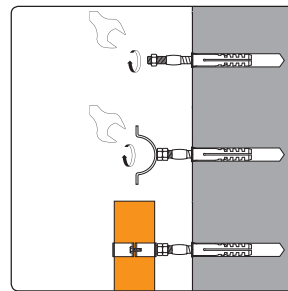

Technical data

Clamp and screw material:	electrolytic zinc plated steel
Anchor material:	polyamide 6

E/CL STEEL CLAMP M6 WITH ISO METRIC HEAD SCREW AND PLUG



Description	Ø drilling (mm)	Drilling depth (mm)	Anchor length (mm)	Ø screw (mm)	Ø tube (inch)	Pack (pcs.)	Code
E/CL 3/8"	10	75	50	M8	3/8"	2	8411001
E/CL 1/2"	10	75	50	M8	1/2"	2	8411002
E/CL 3/4"	10	75	50	M8	3/4"	2	8411003
E/CL 1"	10	75	50	M8	1"	2	8411004
E/CL 1 1/4"	10	75	50	M8	1 1/4"	2	8411005
E/CL 1 1/2"	10	75	50	M8	1 1/2"	2	8411006
E/CL 2"	10	75	50	M8	2"	2	8411007
E/CL 2 1/2"	10	75	50	M8	2 1/2"	2	8411008
E/CL 3"	10	75	50	M8	3"	2	8411009
E/CL 4"	10	75	50	M8	4"	2	8411010

EMB

Multimaterial anchor suitable for supporting brackets, sanitary, HVAC installation, in solid or hollow masonry structures



EMB

Description	Ø drilling (mm)	Anchor length (mm)	Drilling depth (mm)	Max. fixing thickness (mm)	Ø thread (mm)	Screw length (mm)	Pack (pcs.)	Code
EMB 12x70	12	70	80	3	M8	80	2	8719812
EMB 14x75	14	75	90	4	M10	90	2	8719814
Replacement EM 12x70	12	70	80	-	-	-	2	8719922
Replacement EM 14x75	14	75	90	-	-	-	2	8719924

EMC

Multimaterial anchor suitable for water heaters and various equipments installations, in solid or hollow masonry structures



EMC

Description	Ø drilling (mm)	Anchor length (mm)	Drilling depth (mm)	Max. fixing thickness (mm)	Ø thread (mm)	Screw length (mm)	Pack (pcs.)	Code
EMC 14x75	14	75	90	11	M10	95	2	8719714
Replacement EM 14x75	14	75	90	-	-	-	2	8719924

EB/SB

Anchor for sanitary equipments, available in various versions equipped with hook, eyelet or angle hook



EMB

Description	Ø drilling (mm)	Anchor length (mm)	Drilling depth (mm)	Max. fixing thickness (mm)	Ø screw (mm)	Screw length (mm)	Pack (pcs.)	Code
EB/SB 10x75	12	60	75	10	10	75	2	8714102
EB/SB 10x95	12	60	75	30	10	95	2	8714103
EB/SB 10x120	14	75	95	35	10	120	2	8714104

ETS/V

Anchor for sanitary equipments with nickel-plated cap nut and stainless steel screw

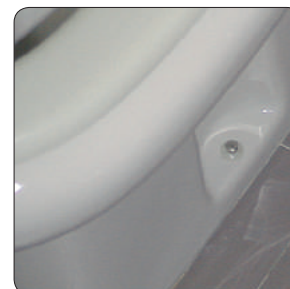

ETS/V

Description	Ø drilling (mm)	Anchor length (mm)	Drilling depth (mm)	Max. fixing thickness (mm)	Ø screw (mm)	Screw length (mm)	Pack (pcs.)	Code
ETS/V stainless steel	10	60	75	5	M6	75	4	8714203

ETS/L

Anchor for wall mounting of sanitary equipments with special polyamide nut and zinc coated screw



ETS/L

Description	Ø drilling (mm)	Anchor length (mm)	Drilling depth (mm)	Max. fixing thickness (mm)	Ø screw (mm)	Screw length (mm)	Pack (pcs.)	Code
ETS/L 10x100	12	60	75	20	M10	100	2	8714303
ETS/L 10x120	12	60	75	40	M10	120	2	8714304
ETS/L 10x140	14	75	90	45	M10	140	2	8714305

IMPACT NAILS

Impact nails for mounting in concrete without pre-drilling



Features and benefits

- Sturdy impact nail, makes mounting on concrete without predrilling very quick and easy
- Long-life nail holder, with ergonomic rubber grip, allows quick and safe operation

Applications

- Clips
- Textile bands
- Supportis and perimetral guides
- Perforated steel straps

MANUAL NAILING SYSTEM



Description	Nail length (m)	Pack (pcs.)	Code
Steel nail 18 mm	18	200	8412122
Nails hammer with ergonomic grip	-	1	8412123

POLYPROPYLENE STRAP FOR FLOOR PIPE FIXING



Description	Rolls length (m)	Pack (pcs.)	Code
Polypropylene strap for floor pipe fixing	10	1	8412120

STRAP KIT FOR FLOOR PIPE FIXING



Description	Pack (pcs.)	Code
1000 nails, 100 m strap, hammer	1	KIT MANUALE

EBAN ZINC PLATED STEEL FOR PIPE FIXING



Description	Length (mm)	Thickness (mm)	Ø internal hole (mm)	Rolls length (m)	Pack (pcs.)	Code
EBAN 12 x 0,8	12	0,8	4,95 (M4)	10	1	8412001
EBAN 17 x 0,8	17	0,8	6,95 (M6)	10	1	8412002
EBAN 26 x 1	26	1	7,95 (M8)	10	1	8412003

EDS

Hexagonal spacers in zinc coated steel, female-female or male-female, for hangers or stand-off mountings with threaded rods



Features and benefits

- The hexagonal spacers allow reliable connection between threaded rods and metric threaded anchors
- Ideal for adjustable stand-off installation

Applications

- Industrial, HVAC, mechanical assembly
- Stand-off fixing for pipe clamps or frames
- Suspended trays

Technical data

Product material: electrolytic zinc plated steel



EDS

Description	Expander dimension (mm)	Version	Length (mm)	Pack (pcs.)	Code
EDS 6x20 - FF	10	FF	20	100	8720001
EDS 6x30 - FF	10	FF	30	100	8720002
EDS 6x40 - FF	10	FF	40	50	8720003
EDS 8x20 - FF	13	FF	20	100	8720004
EDS 8x30 - FF	13	FF	30	100	8720005
EDS 8x40 - FF	13	FF	40	50	8720006
EDS 10x20 - FF	17	FF	20	100	8720007
EDS 10x30 - FF	17	FF	30	50	8720008
EDS 12x30 - FF	19	FF	30	50	8720009
EDS 6x20 - MF	10	MF	20	100	8720011
EDS 6x30 - MF	10	MF	30	100	8720012
EDS 6x40 - MF	10	MF	40	50	8720013
EDS 6x50 - MF	10	MF	50	50	8720014
EDS 8x20 - MF	13	MF	20	100	8720015
EDS 8x30 - MF	13	MF	30	100	8720016
EDS 8x40 - MF	13	MF	40	50	8720017
EDS 8x50 - MF	13	MF	50	50	8720018





RESINS AND CHEMICAL ANCHORING SYSTEMS

MULTIMATERIAL RESINS

PRIMEBLOK

180

STARBLOK

182

MULTIBLOK

184

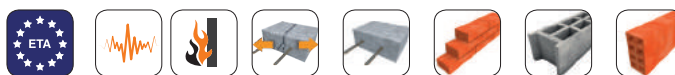

		NET VOLUME cc	RESIN TYPE	ETA	SEISMIC	FIRE RESISTANCE	CRACKED CONCRETE	NON-CRACKED CONCRETE	SOLID BRICK	HOLLOW BLOCK	UNRENDERED HOLLOW BRICK	PAGE
CHEMICAL ANCHORS												
PRIMEBLOK 280 cc/ Universal 410 cc/Coaxial		280 cc 410 cc	Methacrylate high performance	ETA 13/0737 ETA 13/0739 ETA 13/0741				•	•	•	•	180
STARBLOK Universal		280 cc	Methacrylate high performance	ETA 13/0741					•	•	•	182
MULTIBLOK 300 cc/ Universal 410 cc/Coaxial		300 cc 410 cc	Polyester					•	•	•	•	184
CHEMICAL ACCESS- ORIES												185

Technique and installation conditions

WET CONCRETE

Elematic systems are usable in dry concrete, but also wet considering the specific resistance values for this case.

INSTALLATION TEMPERATURE

Chemical anchoring systems are designed to work in a defined temperature range. The support material or the environment low temperatures can prevent the proper anchor functioning.

RESIN SUPPLY

The resin must always be dispensed using the original mixer supplied with the cartridges. Filling starts from the bottom of the hole, progressively climbing up to at least 50% of the volume available. Extension tubes are available for deep holes.

DEEP OR CEILING HOLES

To facilitate the filling results, appropriate accessory use is recommended. The accessory can be used for all hole diameters and can be inserted on all the mixers and extension tubes.



CURING TIMES AND TIGHTENING

Each system has specific curing times needed to reach 100% of the resistance and perform the bar placement. Curing times are longer at low temperature, faster at high temperature. The complete tables are available on the technical data sheets.

DRILLING PROCEDURE

Drilling can be performed with carbide tip (widia) operated in percussion + rotation or with compressed air drills, for all chemical anchoring systems.

HOLE CLEANING

Hole cleaning is essential to ensure the designed performances. The premium cleaning procedure is always recommended. Standard cleaning is allowed for some products, as summarized in the table below.

HOLE CLEANING PROCEDURE

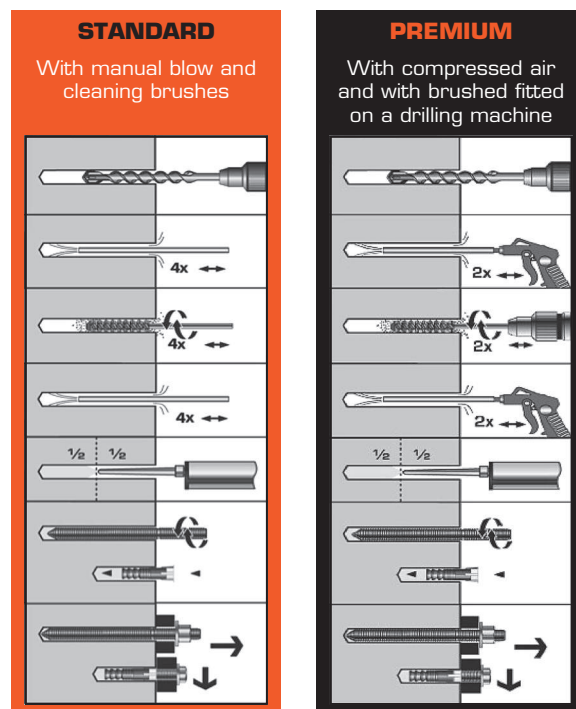

HOW TO CLEAN THE HOLE

	PREMIUM CLEANING	STANDARD CLEANING	WATER CLEANING
PRIMEBLOK	✓	✓ (from 8 to 16 mm)	-
STARBLOK	✓	✓	-
MULTIBLOK	✓	✓	-

PRIMEBLOK

Multimaterial bonded anchor, methacrylate resin based, approved for concrete, solid or hollow masonry structures



Base materials



Features and benefits

- ETA Approved for three field of use: structural anchoring in non-cracked concrete (range M8÷M24); structural post-installed rebars in concrete (range Ø 8 ÷ Ø 20); anchoring in a wide range of masonry structures (range M8÷M12)
- High bonding strength and performance
- Suitable for installation in wet concrete
- Odourless, styren, phtalate and vinyltoluene free, very low content of Volatile Organic Compounds (VOC, class A+), for indoor use
- Easy dosage and delivery in the temperature range from -5°C up to +40°C
- Immediate mix without waste
- Impact resistant and UV proof cartridge with safety piston preventing resin leakage, for clean and safe operation
- 18 months shelf life
- Partly used cartridges can be reused after fitting new nozzle

Applications

- HVAC installations, such as steel brackets for pipings and channels
- Balustrading, safety barriers
- Structural anchoring for steel works
- Metal doors and windows
- Awnings, curtain rails, blinds
- Satellite dishes, aerials
- Bearing structures for photovoltaic plants
- Post-installed rebars for concrete

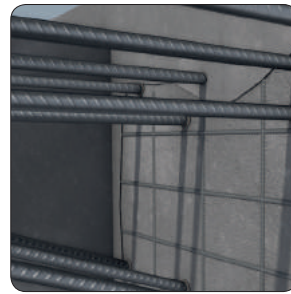

Installation

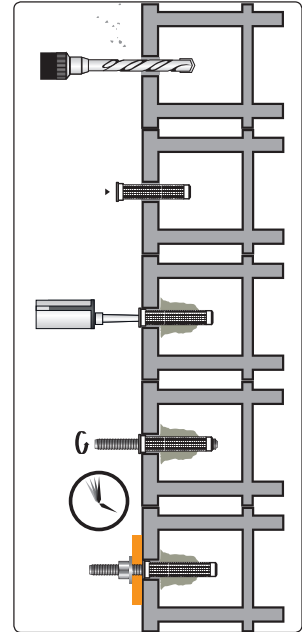
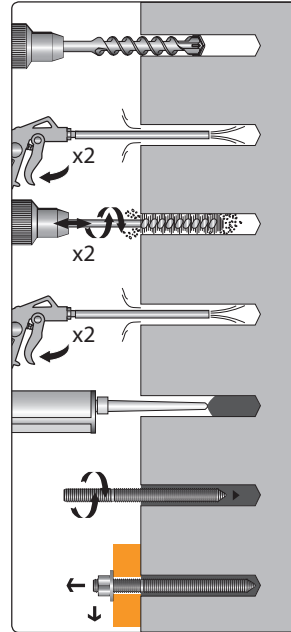

Approvals and certifications



ETA 13/0737
EAD 330499-00-0601
Option 7



ETA 13/0739
EAD 330499-00-0601



ETA 13/0741
EAD 330076-00-0604



Volatile Organic Compounds
A+

Curing times for installation

Support temperature	Curing time	100% of resistance
30 ÷ 40°C	2 min	35 min (70 min*)
20 ÷ 30°C	4 min	45 min (90 min*)
10 ÷ 20°C	6 min	60 min (120 min*)
5 ÷ 10°C	12 min	90 min (180 min*)
0 ÷ 5°C	18 min	180 min (360 min*)
-5 ÷ 0°C	-	360 min (720 min*)

* curing times for laying on damp concrete

PRIMEBLOK



Description	Net volume (cc)	Type of injection gun	Injectors for cartridge (pcs.)	Pack (pcs.)	Outer carton (pcs.)	Code
Primeblok cartridge 280 cc	280	one-component	2	1	12	059511
Primeblok cartridge 410 cc	410	coaxial bi-component	2	1	12	059510

POLYETHYLENE INJECTION ANCHOR SLEEVE WITH CENTRING CAP



Description	Ø thread (mm)	Thread length (mm)	Ø drilling (mm)	Drilling depth (mm)	Fixing thickness (mm)	Pack (pcs.)	Code
BE 12x45	M6 - M8	80	12	55	15	10	8708955
BE 12x60	M6 - M8	90	12	70	15	10	8708956
BE 12x80	M6 - M8	110	12	90	15	10	8708957
BE 15x85	M8 - M10	110	15	95	15	10	8708952
BE 15x130	M8 - M10	130	15	145	20	10	8708953
BE 20x85	M12	160	20	95	25	10	8708954

ZINC PLATED ROD ANCHORING

Ø	Application conditions in mm		Recommended tensile loads - Nrec in kN (1 kN ~ 100 Kg)
	Ø drilling	Embedment depth	Non-cracked concrete C20/25
M8	10	80	8,64
M10	12	90	10,07
M12	14	110	14,00
M16	18	125	19,92
M20	25	170	33,92
M24	28	210	47,14

Indicative recommended loads for single anchor.
For dimensioning and complete resistance data of anchoring carried out with bars and reinforcing bars, consult the technical data sheets

ROD ANCHORING WITH BE ANCHOR SLEEVE

Ø	Application conditions in mm		Recommended tensile loads - Nrec in kN (1 kN ~ 100 Kg)
	Ø drilling	Min. embedment depth	Unrendered hollow brick
M8	15	85	0,30
M10	15	85	0,30
M12	20	85	0,70

Indicative recommended loads for single anchor.
For dimensioning and complete resistance data, of anchoring carried out with bars and reinforcing bars, consult the technical data sheets

For chemical fixing and cleaning accessories see page 185

STARBLOK

Complete bonded anchor kit suitable for wide range of hollow or solid masonry structures



Base materials



Features and benefits

- The system combines the new Primeblok bonded anchor with the innovative and exclusive Starblok accessory for approved fixing with threaded rods from M8 to M10 on hollow masonry substrates
- The special sponge bulb evenly distributes the resin, compensating the masonry embrittlement due to drilling, avoids waste for more reliable performance
- The system can be installed in every positions in virtually all kinds of hollow building blocks
- The threaded rod embedment can be adjusted to avoid protrusion thanks to the precut sleeve bottom
- Primeblok resin is odourless, styren, phtalate and vinyltoluene free, VOC class A+, for indoor use. It has 18 months of shelf life, partly used cartridges can be reused after fitting new nozzle

Installation

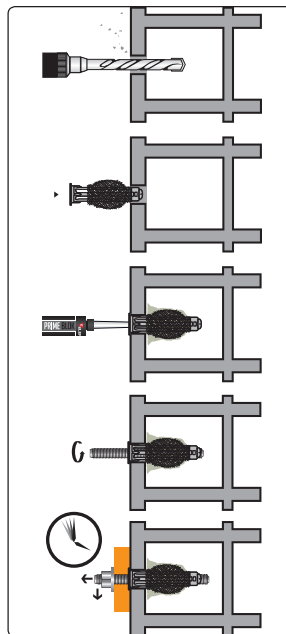

Approvals and certifications



ETA 13/0741
ETAG 029
All C



Volatile Organic
Compounds
A+

Applications

- HVAC installations, such as steel brackets for pipes and channels
- Awnings, curtain rails, blinds
- Satellite dishes, aerials

Curing times for installation

Support temperature	Curing time	100% of resistance
30 + 40°C	2 min	35 min (70 min*)
20 + 30°C	4 min	45 min (90 min*)
10 + 20°C	6 min	60 min (120 min*)
5 + 10°C	12 min	90 min (180 min*)
0 + 5°C	18 min	180 min (360 min*)
-5 + 0°C	-	360 min (720 min*)

* curing times for laying on damp concrete

STARBLOK KIT FOR ROD/SCREWS M8 AND M10 (ROD/SCREWS NOT INCLUDED)

Description	Pack (pcs.)	Code
STARBLOK KIT FOR M8 AND M10 BAR/SCREWS	1	568705
Kit composition:		
Starblok - sleeve for hollow materials fixing	8	
Primeblok chemical cartridge 280ml	1	
Starblok special mixer	2	

STARBLOK KIT FOR SATELLITE DISHES AND ANTENNAS (8 RODS INCLUDED)

Description	Pack (pcs.)	Code
STARBLOK KIT WITH M8 BARS FOR SATELLITE DISHES AND ANTENNAS	1	568706
Kit composition:		
Starblok - sleeve for hollow materials fixing	8	
M8x110 threaded bars	8	
Primeblok chemical cartridge 280ml	1	
Starblok special mixer	2	



STARBLOK SLEEVE FOR SATELLITE DISHES AND ANTENNAS (8 RODS INCLUDED)

Description	Pack (pcs.)	Code
StarBlock sleeve for hollow materials fixing	50	569481

Ø rebar	Application conditions in mm		Recommended tensile loads - Nrec in kN (1 kN ~ 100 Kg)	
	Ø drilling	Embedment depth	Unrendered hollow brick	Concrete hollow block
M8	16	80	0,50	1,00
M10	16	80	0,50	1,00

Recommended loads for single anchor. Consult the technical documentation for the correct fixing sizing

For chemical fixing and cleaning accessories see page 185

MULTIBLOK

General purpose, multimaterial bonded anchor, polyester resin based, suitable for solid or hollow masonry structures



Base materials



Features and benefits

- Suitable for non-structural applications in concrete or masonry structures in the range M6÷M16
- Quick curing times for fast installation (e.g. 20 minutes at 25°C)
- Impact resistant and UV proof polymer cartridge with safety piston preventing resin leakage, for clean and safe operation
- Styren free and very low content of Volatile Organic Compounds (VOC, class A+)
- 12 months shelf life
- Partly used cartridges can be reused after fitting new nozzle

Applications

- Balustrading, handrails
- Fencing, gates, barriers
- Awnings, curtain rails, blinds
- Lightweight HVAC installation
- Temporary fixing



Certification



Volatile Organic Compounds
A+

Installation

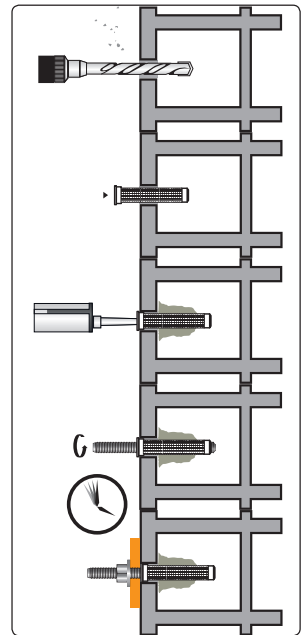
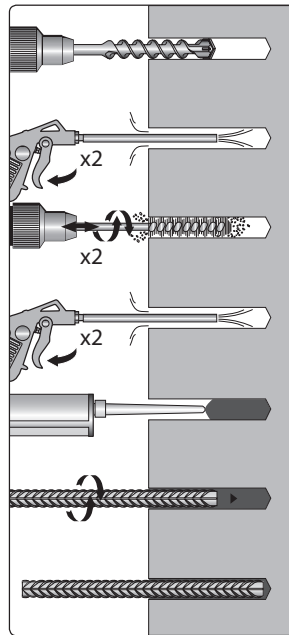

Curing times for installation

6 h	Curing time	100% of resistance
25 ÷ 30°C	2 min	35 min
20 ÷ 24°C	3 min	40 min
15 ÷ 19°C	4 min	50 min
10 ÷ 14°C	8 min	1 h 20 min
-5 ÷ 9°C	10 min	2 h 25 min

Description	Net volume (cc)	Type of injection gun	Injectors for cartridge (pcs.)	Pack (pcs.)	Carton (pcs.)	Code
Multiblok cartridge 300 cc	300	one-component	2	1	12	059513
Multiblok cartridge 410 cc	410	coaxial bi-component	2	1	12	059512

For chemical fixing and cleaning accessories see page 185

Chemical Fixing and Cleaning Accessories

EHD BAR

FOR ZINC PLATED ANCHOR SLEEVE, 5.8 CLASS, WITH NUT AND WASHER



Description	Ø thread (mm)	Anchor length (mm)	Ø drilling with BE anchor sleeves (mm)	Drilling depth with BE anchor sleeves (mm)	Fixing thickness (mm)	Pack (pcs.)	Code
M8x110	M8	110	15	90	10	10	8730101
M10x110	M10	110	15	90	10	10	8730102
M10x160	M10	160	15	140	10	10	8730104
M12x115	M12	115	20	90	10	10	8730105
M16x190	M16	190	-	-	-	5	8730107

BT METAL ANCHOR SLEEVE

ZINC PLATED, INTERNALLY THREADED



Description	Ø compatible bar	Ø drilling on solid material (mm)	Sleeve length (mm)	Drilling depth on solid material (mm)	Pack (pcs.)	Code
BT M8 internal thread	M8	14	80	90	10	8708981
BT M10 internal thread	M10	16	80	90	10	8708982
BT M12 internal thread	M12	18	80	90	10	8708983

POLYETHYLENE INJECTION ANCHOR SLEEVE

FOR CHEMICAL FIXING ON HOLLOW BASE MASONRY



Description	Ø compatible bar	Ø drilling (mm)	Min. bar length (mm)	Max. fixing thickness (mm)	Pack (pcs.)	Code
BE 12x45 mm	M6-M8	12	65	-	10	8708955
BE 12x60 mm	M6-M8	12	80	-	10	8708956
BE 12x80 mm	M6-M8	12	110	10*	10	8708957
BE 15x85 mm	M8-M10	15	110-160	10-55*	10	8708952
BE 15x130 mm	M8-M10	15	160	10*	10	8708953
BE 20x85 mm	M12	20	115	10*	10	8708954
PE 15x85 mm	M8-M10	15	110-160	10-55*	10	557070
PE 15x130 mm	M8-M10	15	160	10*	10	557080
PE 20x85 mm	M12	20	115	10*	10	557090

* Maximum fixing thickness with EHD bars

METAL ANCHOR SLEEVES

ZINC PLATED STEEL, FOR CHEMICAL FIXING ON HIGH DEPTH HOLLOW MASONRY



Description	Ø compatible bar	Ø drilling (mm)	Sleeve length (mm)	Pack (pcs.)	Code
BM Ø12x1000 mm	M8-M10	12	1000 - to cut	10	8708961
BM Ø16x1000 mm	M10-M12	16	1000 - to cut	10	8708962
BM Ø22x1000 mm	M16	22	1000 - to cut	6	8708963





MANUAL TOOLS

WIRING TOOLS

Cable Tie Tools	190
EZ-CRIMP	192
Crimping Tools	194
Stripping And Cutting Tools	197
Cable Stripping Tools	198
Cable Cutters	199

HOT AIR GUNS

Hot Air Guns	201
--------------	-----

Tensioning Tool 5401

Automatic tensioning tool in painted steel, suitable for cable ties from 2,2 to 4,8 mm width



Features and benefits

- Manually adjustable tension force
- Automatic cutting at set tension

Item code

Description	Length (mm)	Weight (gr)	Pack (pcs.)	Code
Metal tensioning tool suitable for ties from 2,2 to 4,8	160	310	1	5401

Tensioning Tool 5400 C

Manual tensioning tool in painted steel, suitable for cable ties from 3,5 to 9 mm width



Features and benefits

- Manually adjustable tension force
- Dedicated lever cut

Item code

Description	Length (mm)	Weight (gr)	Pack (pcs.)	Code
Metal tensioning tool suitable for ties from 3,5 to 9	190	290	1	5400C

Tensioning Tool 5403

Automatic tensioning tool in plastic, suitable for cable ties from 2,2 to 4,8 mm width



Features and benefits

- Manually adjustable tension force
- Automatic cutting at set tension

Item code

Description	Length (mm)	Weight (gr)	Pack (pcs.)	Code
Plastic tensioning tool suitable for ties from 2,2 to 4,8	165	221	1	5403

Tensioning Tool 5406 C

Manual tensioning tool in painted steel, suitable for cable ties from 3,5 to 12,5 mm width



Features and benefits

- Manually adjustable tension force
- Dedicated lever cut

Item code

Description	Length (mm)	Weight (gr)	Pack (pcs.)	Code
Metal tensioning tool suitable for ties from 3,5 to 12,5	190	260	1	5406 C

Tensioning Tool 5405 C

Manual tensioning tool in painted steel, suitable for cable ties from 3,5 to 13 mm width



Features and benefits

- Manually adjustable tension force
- Automatic cutting at set tension

Item code

Description	Length (mm)	Weight (gr)	Pack (pcs.)	Code
Metal tensioning tool suitable for ties from 3,5 to 13	200	320	1	5405 C

Tensioning Tool 5407

Automatic tensioning tool for stainless steel cable ties up to 7,9 mm maximum width



Features and benefits

- Manually adjustable tension force
- Automatic cutting at set tension to cut the cable tie tail without any smudge

Item code

Description	Length (mm)	Weight (gr)	Pack (pcs.)	Code
Stainless steel tensioning tool for ties 7,9 max	178	560	1	5407

EZ-CRIMP

Patented crimping tool with interchangeable crimping dies. Realised in hard steel with ergonomic handles made of anti-slip material

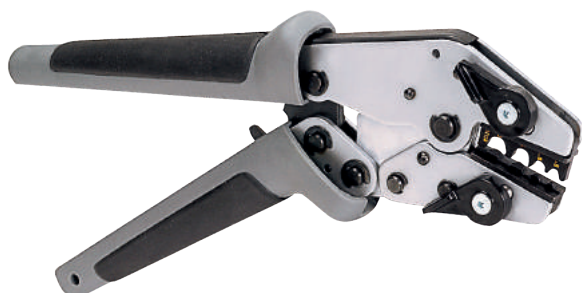

Features and benefits

- Manually interchangeable dies without tools ("easy change" release system)
- Stop ratchet with release option to guarantee perfect and optimal crimping
- Adjustable pressure force
- Dies manual release lever
- The interchangeable matrices make the tool extremely versatile, one tool body for different applications, with dedicated matrices
- Micro casted steel dies for coupling precision and high tear and wear resistance

Applications

- Industrial panels and switchboards

Item code

Description	Length (mm)	Width (mm)	Weight (gr)	Pack (pcs.)	Code
EZ CRIMP 250x80 mm tool only	250	80	580	1	9400 U





EZ CRIMP Dies Kit

Description	Composition	Pack (pcs.)	Code
EZ CRIMP + 5 dies	9400 U (EZ CRIMP) 9400 M-TB16 9400 M-TB35 9400 M-CP6 9400 M-CN10 9400 M-CO2,5	1	9400
EZ CRIMP + 3 dies	9400 U (EZ CRIMP) 9400 M-TB16 9400 M-TB35 9400 M-CP6	1	9401
EZ CRIMP + 5 dies for photovoltaic systems	9400 U (EZ CRIMP) 9400 M-TB16 9400 M-CP6 9400 M-CN10 9400 M-MC3 9400 M-MC4	1	9400 FV

EZ CRIMP Standard Crimping Dies



STANDARD CRIMPING DIES FOR TERMINALS AND CONNECTORS

Description	Pack (pcs.)	Code
 Crimping die for copper terminals 0,5÷6 mm ²	1	9400 M-TB6
 Crimping die for copper terminals 0,5÷16 mm ²	1	9400 M-TB16
 Crimping die for copper terminals 16÷35 mm ²	1	9400 M-TB35
 Crimping die for copper terminals 25÷50 mm ²	1	9400 M-TB50



Description	Pack (pcs.)	Code
 Crimping die for preinsulated terminals 0,5÷6 mm ²	1	9400 M-CP6
 Crimping die for preinsulated terminals 0,5÷10 mm ²	1	9400 M-CN10
 Crimping die for naked Faston 0,5÷2,5 mm ²	1	9400 M-CO2,5
 Crimping die for heat-shrink butt connectors 0,5÷6 mm ²	1	9400 M-CT6

EZ CRIMP Special Crimping Dies



CRIMPING DIES FOR ALL COAX CONNECTORS

Description	Pack (pcs.)	Code
 Crimping die for coax BNC/TNC	1	9400 M-CC1
 Crimping die for coax N	1	9400 M-CC4
 Crimping die for coax CATV type F/BNC/TNC	1	9400 M-CC5

CRIMPING DIES FOR PHOTOVOLTAIC SYSTEMS

Description	Pack (pcs.)	Code
 Crimping die for Multi Contact/MC3 and corresponding connectors	1	9400 M-MC3
 Crimping die for Multi Contact/MC4 and corresponding connectors	1	9400 M-MC4
 Crimping die for Tyco and corresponding connectors, non insulated butt connectors	1	9400 M-TC6

CRIMPING DIES FOR UNSHIELDED PLUGS AND CONNECTORS (phone lines, wiring, computer, service stations)

Description	Pack (pcs.)	Code
 Crimping die for RJ45/8P8K connectors	1	9400 M-WES1
 Crimping die for RJ11/RJ12/6P6K connectors	1	9400 M-WES2
 Die for RJ45/8P8K/AMP connectors	1	9400 M-WES4

Crimping Tool 9102

Crimping tool with plastic handles and re-opening spring. Suitable for copper terminals from 0,5 to 2,5 mm²



Item code

Description	Length (mm)	Weight (gr)	Section min (mm ²)	Section max (mm ²)	Pack (pcs.)	Code
Crimping tool for copper terminals 0,5÷2,5 mm ²	145	160	0,5	2,5	1	9102

Crimping Tool 9039A

Steel plated crimping tool with micro casted steel dies and plastic handles. Suitable for copper terminals from 0,5 to 6 mm²



Features and benefits

- Adjustable crimping force
- Handle stop ratchet with automatic release

Item code

Description	Length (mm)	Weight (gr)	Section min (mm ²)	Section max (mm ²)	Pack (pcs.)	Code
Crimping tool for copper terminals 0,5÷6 mm ²	180	390	0,5	6	1	9039 A

Crimping Tool 9004

Crimping tool with plastic handles and re-opening spring. Suitable for copper terminals from 0,7 to 10 mm²



Item code

Description	Length (mm)	Weight (gr)	Section min (mm ²)	Section max (mm ²)	Pack (pcs.)	Code
Crimping tool for copper terminals 0,75÷10 mm ²	180	320	0,75	10	1	9004

Crimping Tool 9039

Steel plated crimping tool with micro casted steel dies and plastic handles. Suitable for copper terminals from 6 to 16 mm²



Features and benefits

- Adjustable crimping force
- Handle stop ratchet with automatic release

Item code

Description	Length (mm)	Weight (gr)	Section min (mm ²)	Section max (mm ²)	Pack (pcs.)	Code
Crimping tool for copper terminals 6÷16 mm ²	205	380	6	16	1	9039

Crimping Tool 9302

Steel plated crimping tool with micro casted steel dies and blackened finishing. Suitable for copper terminals from 0,08 to 10 mm²



Features and benefits

- Square crimping and terminal lateral insertion
- Ergonomic handle in two-component material
- Safety device with mechanical release for perfect crimping

Item code

Description	Length (mm)	Weight (gr)	Section min (mm ²)	Section max (mm ²)	Pack (pcs.)	Code
Crimping tool for copper terminals 0,08÷10 mm ²	180	392	0,08	180	1	9302

Crimping Tool 9007

Steel plated crimping tool with micro casted steel dies and plastic handles. Suitable for preinsulated copper lugs from 0,5 to 6 mm²



Features and benefits

- Adjustable jaw clamping device
- Handle stop ratchet with automatic release

Item code

Description	Length (mm)	Weight (gr)	Section min (mm ²)	Section max (mm ²)	Pack (pcs.)	Code
Crimping tool for copper preinsulated terminals 0,5÷6 mm ²	220	500	0,5	6	1	9007

Crimping Tool 9304

Steel plated crimping tool with micro casted steel dies and blackened finishing. Suitable for copper terminals from 0,08 to 16 mm²



Features and benefits

- Square crimping and terminal lateral insertion
- Safety device with mechanical release for perfect crimping
- Ergonomic handle in two-component material
- Easy to use in areas with difficult access and preselection of two different working ranges

Item code

Description	Length (mm)	Weight (gr)	Section min (mm ²)	Section max (mm ²)	Pack (pcs.)	Code
Crimping tool for copper terminals 0,08÷16 mm ²	190	475	0,08	16	1	9304

Crimping Tool 9020

Steel plated crimping tool with plastic handles. Suitable for non-insulated open barrel terminals from 0,5 to 6 mm²

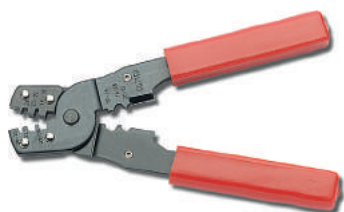

Item code

Description	Length (mm)	Weight (gr)	Section min (mm ²)	Section max (mm ²)	Pack (pcs.)	Code
Crimping tool for non-insulated copper terminals 0,5÷6 mm ²	185	210	0,5	6	1	9020

Crimping Tool 9048

Steel plated crimping tool with micro casted head, metal reinforced handles and anti-slip covers. Suitable for copper lugs from 1,5 to 16 mm²



Features and benefits

- Adjustable jaw clamping device
- Handle stop ratchet with automatic release

Item code

Description	Length (mm)	Weight (gr)	Section min (mm ²)	Section max (mm ²)	Pack (pcs.)	Code
Crimping tool for copper lugs 1,5÷16 mm ²	275	520	1,5	16	1	9048

Crimping Tool 9049

Steel plated crimping tool with micro casted steel dies. Suitable for non-insulated open barrel terminals from 0,5 to 6 mm²



Features and benefits

- Adjustable jaw clamping device
- Handle stop ratchet with automatic release

Item code

Description	Length (mm)	Weight (gr)	Section min (mm ²)	Section max (mm ²)	Pack (pcs.)	Code
Crimping tool for non-insulated copper terminals 0,5÷6 mm ²	225	510	0,5	6	1	9049

Crimping Tool 9038

Crimping tool with micro casted head and handles, and pressed steel stamp and die. Suitable for copper lugs from 10 to 95 mm²



Item code

Description	Length (mm)	Weight (gr)	Section min (mm ²)	Section max (mm ²)	Pack (pcs.)	Code
Crimping tool for copper lugs 10÷95 mm ²	570	3100	10	95	1	9038

Crimping Tool

Crimping tool with casted head, reinforced metal handles, and micro casted steel stamp and die. Suitable for copper lugs up to 120 mm²

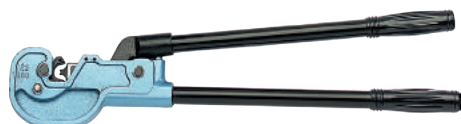

Features and benefits

- Anti-slip plastic handles

Item code

Description	Length (mm)	Weight (gr)	Section min (mm ²)	Section max (mm ²)	Pack (pcs.)	Code
Crimping tool for copper lugs 25÷120 mm ²	660	4500	25	120	1	9068
Crimping tool for copper lugs 16÷95 mm ²	655	4400	16	95	1	9069
Crimping tool for copper lugs 10÷50 mm ²	570	3280	10	50	1	9071

Crimping Tool 9075

Zinc plated crimping tool with reinforced metal handles with anti-slip covers and hexagonal crimping die. Suitable for copper lugs from 6 to 120 mm²



Features and benefits

- Manual hexagonal crimping
- Anti-slip plastic handles

Item code

Description	Length (mm)	Weight (gr)	Section min (mm ²)	Section max (mm ²)	Pack (pcs.)	Code
Crimping tool for copper lugs 6÷120 mm ²	650	3900	6	120	1	9075

Stripping-cutting Tool 9305

Automatic stripping and cutting tool with fiberglass body and bimaterial handles. Suitable for cables from 0,03 to 10mm²



Features and benefits

- Automatic adjustment for excellent stripping
- Metal clamping jaws
- Cable stripping device with adjustable stop from 5 to 20 mm
- Fiberglass body

Item code

Description	Length (mm)	Weight (gr)	Section min (mm ²)	Section max (mm ²)	Pack (pcs.)	Code
Stripping/cutting tool suitable for cables from 0,03 to 10 mm ²	195	200	0,03	10	1	9305

Stripping-cutting Tool 5415

Automatic stripping and cutting tool in plastic. Suitable for cables from 0,5 to 4 mm²



Item code

Description	Length (mm)	Weight (gr)	Section min (mm ²)	Section max (mm ²)	Pack (pcs.)	Code
Stripping/cutting tool suitable for cables from 0,5 to 4 mm ²	170	138	0,5	4	1	5415

Stripping Tool 9056

Automatic stripping tool with steel blades. Suitable for cables from 0,5 to 6 mm²



Item code

Description	Length (mm)	Weight (gr)	Section min (mm ²)	Section max (mm ²)	Pack (pcs.)	Code
Stripping tool suitable for cables from 0,5 to 6 mm ²	170	338	0,5	6	1	9056

Stripping-cutting Tool 11909001

Stripping and cutting tool. Suitable for crimping modular plugs with 6-8 poles

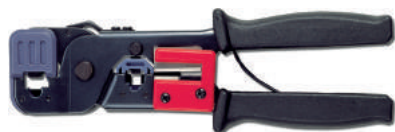

Features and benefits

- Ideal for RJ11, RJ12, RJ45 connectors

Item code

Description	Length (mm)	Weight (gr)	Pack (pcs.)	Code
Tool for modular connectors and terminals	200	320	1	11909001

Neoprene Sleeves Tool

Neoprene sleeves tool with 3 needles



Features and benefits

- The special opening system expands the sleeve uniformly, facilitating the installation

Item code

Description	ø min. internal (mm ²)	ø max. internal (mm ²)	Pack (pcs.)	Code
Neoprene sleeves tool 1,75÷5 mm	1,75	5	1	5416
Neoprene sleeves tool 3÷10 mm	3	10	1	5417
Neoprene sleeves tool 10÷17 mm	10	17	1	5418

Stripping Tool 9058

Stripping tool with round cable screw, plastic and metal body. Suitable for cables diameters from 4 to 28 mm



Features and benefits

- Adjustable blade in tempered steel

Item code

Description	Length (mm)	Weight (gr)	Pack (pcs.)	Code
Stripping tool suitable for cables from 4 to 28 mm ²	135	71	1	9058

Stripping Tool 9062

Hook stripping tool with round cable screw, plastic and metal body. Suitable for cables diameters from 8 to 28 mm



Features and benefits

- Adjustable blade in tempered steel with a passivated steel hook

Item code

Description	Length (mm)	Weight (gr)	Pack (pcs.)	Code
Stripping tool suitable for cables from 8 to 28 mm ²	180	90	1	9062

Cable Cutter 9033

Cable cutter for copper and alloy cables. Suitable for cables diameters up to 25 mm (~150 mm²)



Features and benefits

- Made of forged steel, with sharpened and hardened blades

Item code

Description	Length (mm)	Weight (gr)	Pack (pcs.)	Code
Cable cutter tool max 25 mm ²	200	300	1	9033

Cable Cutter 9032

Cable cutter for copper and alloy cables. Suitable for cables diameters up to 15 mm (~50 mm²)



Features and benefits

- Made of forged steel, with sharpened and hardened blades

Item code

Description	Length (mm)	Weight (gr)	Pack (pcs.)	Code
Cable cutter tool max 15 mm ²	170	210	1	9032

Cable Cutter 9051

Cable cutter for copper and alloy cables. Suitable for cables diameters up to 250 mm²



Features and benefits

- Casted metal handles with plastic covers, treated steel blades

Item code

Description	Length (mm)	Weight (gr)	Pack (pcs.)	Code
Cable cutter tool max 250 mm ²	600	1540	1	9051

Cable Cutter 9052

Cable cutter for copper and alloy cables. Suitable for cables diameters up to 500 mm²



Features and benefits

- Casted metal handles with plastic covers, treated steel blades

Item code

Description	Length (mm)	Weight (gr)	Pack (pcs.)	Code
Cable cutter tool max 500 mm ²	800	2880	1	9052

Cable Cutter 9054

Cable cutter for copper and alloy cables. Suitable for cables diameters up to 300 mm²



Features and benefits

- Painted metal handles with plastic covers

Item code

Description	Length (mm)	Weight (gr)	Pack (pcs.)	Code
Cable cutter tool max 300 mm ²	250	680	1	9054

Hot Air Gun 12200013

2-speed hot air gun, 1500W



Features and benefits

- Position 1: 1000W power, temperature 375°C, air flow 200 l/min
- Position 2: 1500W power, temperature 495°C, air flow 400 l/min

Item code

Description	Length (mm)	Weight (gr)	Pack (pcs.)	Code
Hot air gun 1500W	240	670	1	12200013

Hot Air Gun 12200016

2-speed Steinel hot air gun, 1600W



Features and benefits

- Micanite resistance
- Ergonomic handle
- Position 1: 800W power, temperature 300°C, air flow 240 l/min
- Position 2: power 1600W, temperature 500°C, air flow 450 l/min

Item code

Description	Length (mm)	Weight (gr)	Pack (pcs.)	Code
2-speed Steinel hot air gun 1600W	252	671	1	12200016

Hot Air Gun 12200011

Portable multifunctional gas tool



Features and benefits

- Butane gas capacity: 6 ml
- Average autonomy: about 30 minutes depending on the setting
- Hot air gun temperature 450°C
- Welder temperature 200°C/400°C

Instructions

- Rechargeable with gas bottle for normal lighters
- For safety reasons, the product is supplied without gas
- Suitable for intermittent use, not for continuous use



HOT GUN



SOLDERING IRON



BURNER

Item code

Description	Length (mm)	Weight (gr)	Pack (pcs.)	Code
Welder-burner gas tool	150	60	1	12200011





CARTONS

Cable Ties and Accessories	204
Cabling and Connection	207
Cable Protection	212
Mechanical Anchors	214
Chemical Anchors	223
Muchanical Anchor Blisters	224

DOUBLE METALLIC TOOTH CABLE TIES

2-LOCK CABLE TIES

page 15

Code	Dimensions (mm)	Pack pcs.	Outer Carton pcs.
Natural			
1203	2,5x100	100	15.000
1207	2,5x200	100	8.000
1209	3,5x140	100	7.000
1214	3,5x200	100	7.000
1210	3,5x290	100	4.500
1215	4,5x200	100	4.000
1216	4,5x250	100	4.500
1217	4,5x290	100	3.500
1219	4,5x360	100	3.000
1225	7,5x220	100	2.000
1227	7,5x360	100	1.500
Black			
1303	2,5x100	100	15.000
1307	2,5x200	100	8.000
1309	3,5x140	100	7.000
1314	3,5x200	100	7.000
1310	3,5x290	100	4.500
1315	4,5x200	100	4.000
1316	4,5x250	100	4.500
1317	4,5x290	100	3.500
1319	4,5x360	100	3.000
1325	7,5x220	100	2.000
1327	7,5x360	100	1.500

2-LOCK CABLE TIES - 20 PCS.

page 15

Code	Dimensions (mm)	Pack pcs.	Outer Carton pcs.
Natural			
1214/20	3,5x200	20	1.000
1210/20	3,5x290	20	1.000
1215/20	4,5x200	20	1.000
1217/20	4,5x290	20	1.000
1219/20	4,5x360	20	700
1227/20	7,5x360	20	500
Black			
1314/20	3,5x200	20	1.000
1310/20	3,5x290	20	1.000
1315/20	4,5x200	20	1.000
1317/20	4,5x290	20	1.000
1319/20	4,5x360	20	700
1327/20	7,5x360	20	500

WIRING CABLES TIES

STANDARD CABLE TIES

page 17

Code	Dimensions (mm)	Pack pcs.	Outer Carton pcs.
Natural			
5203/CE	2,5x98	100	15.000
5203E	2,5x98	1.000	40.000
5203/B2	2,5x98	20.000	20.000
5205/CE	2,5x135	100	12.000
5205E	2,5x135	1.000	30.000
5206/CE	2,6x160	100	10.000
5207/CE	2,6x200	100	8.000
5207E	2,6x200	1.000	25.000
5209/CE	3,5x140	100	7.000
5209E	3,5x140	1.000	20.000
5214/CE	3,5x200	100	7.000
5214E	3,5x200	1.000	15.000
5210/CE	3,5x290	100	4.500
5210E	3,5x290	500	10.000
5208E	3,5x370	100	4.000
5211/CE	4,5x160	100	6.000
5211E	4,5x160	1.000	15.000
5213/CE	4,8x178	100	5.000
5213E	4,8x178	1.000	12.000
5215/CE	4,5x200	100	4.000
5215E	4,8x200	1.000	10.000
5216/CE	4,8x250	100	4.500
5217E	4,5x290	100	3.500
5219E	4,5x360	100	3.000
5218E	4,5x390	100	5.000
5220E	4,5x430	100	5.000
5223E	7,8x180	100	2.500
5225E	7,8x240	100	2.000
5226E	7,8x300	100	1.500
5227E	7,5x365	100	1.500
5229E	7,5x450	100	2.500
5231E	7,5x540	100	2.000
5233E	7,5x750	100	1.200
5234E	9,0x780	100	1.000
5235E	12,5x225	50	2.000
5237E	12,5x500	50	1.000
5239E	12,5x720	50	600
5241E	12,5x850	50	600
5243E	12,5x1.000	50	500
Black			
5303/CE	2,5x98	100	15.000
5303E	2,5x98	1.000	40.000
5303/B2	2,5x98	20.000	20.000
5305/CE	2,5x135	100	12.000
5305E	2,5x135	1.000	30.000
5306/CE	2,6x160	100	10.000
5307/CE	2,6x200	100	8.000
5307E	2,6x200	1.000	25.000
5309/CE	3,5x140	100	7.000

Code	Dimensions (mm)	Pack pcs.	Outer Carton pcs.
5309E	3,5x140	1.000	20.000
5314/CE	3,5x200	100	7.000
5314E	3,5x200	1.000	15.000
5310/CE	3,5x290	100	4.500
5310E	3,5x290	500	10.000
5308E	3,5x370	100	4.000
5311/CE	4,5x160	100	6.000
5311E	4,5x160	1.000	15.000
5313/CE	4,8x178	100	5.000
5313E	4,8x178	1.000	12.000
5315/CE	4,5x200	100	4.000
5315E	4,8x200	1.000	10.000
5316/CE	4,8x250	100	4.500
5317E	4,5x290	100	3.500
5319E	4,5x360	100	3.000
5318E	4,5x390	100	5.000
5320E	4,5x430	100	5.000
5323E	7,8x180	100	2.500
5325E	7,8x240	100	2.000
5326E	7,8x300	100	1.500
5327E	7,5x365	100	1.500
5329E	7,5x450	100	2.500
5331E	7,5x540	100	2.000
5333E	7,5x750	100	1.200
5334E	9,0x780	100	1.000
5335E	12,5x225	50	2.000
5337E	12,5x500	50	1.000
5339E	12,5x720	50	600
5341E	12,5x850	50	600
5343E	12,5x1.000	50	500

INSTALLATION CABLE TIES

EASY BELTURING CABLE TIES

page 19

Code	Dimensions (mm)	Pack pcs.	Outer Carton pcs.
Black - Single head			
6551E	8,8x180	100	4.000
Black - Double head			
6553E	8,8x270	100	2.500
6555E	8,8x360	100	2.000

BELTURING PLUS CABLE TIES

page 21

Code	Dimensions (mm)	Pack pcs.	Outer Carton pcs.
Black - Single head			
6449XE	6x115	100	7.000
6450XE	6x180	100	4.800
6452XE	6x290	100	3.500
6454XE	6x360	100	1.500

Code	Dimensions (mm)	Pack pcs.	Outer Carton pcs.
6447XE	9x132	100	4.800
6451XE	9x180	100	4.800
Black - Double head			
6453XE	9x260	100	2.000
6448XE	9x300	100	1.500
6455XE	9x360	100	1.500
6456XE	9x510	100	800
6457XE	9x760	100	400

COLSPEED CABLE TIES

page 22

Code	Dimensions (mm)	Pack pcs.	Outer Carton pcs.
Black - Single head			
6501E	8,8x200	100	4.000
Black - Double head			
6502E	8,8x290	100	2.500
6503E	8,8x380	100	2.000

SPECIAL CABLE TIES

UV-RESISTANT CABLE TIES

page 23

Code	Dimensions (mm)	Pack pcs.	Outer Carton pcs.
Black			
5303/C UVE	2,5x98	100	15.000
5309/C UVE	3,5x140	100	7.000
5314/C UVE	3,5x200	100	7.000
5315/C UVE	4,8x200	100	4.000
5317 UVE	4,5x290	100	3.500
5327 UVE	7,5x365	100	1.500

HEAT RESISTANT CABLE TIES

page 24

Code	Dimensions (mm)	Pack pcs.	Outer Carton pcs.
Natural			
5203/C TE	2,5x98	100	15.000
5209/C TE	3,5x140	100	7.000
5214/C TE	3,5x200	100	7.000
5215/C TE	4,8x200	100	4.000
5217 TE	4,5x290	100	3.500
5227 TE	7,5x365	100	1.500
Black			
5303/C TE	2,5x98	100	15.000
5309/C TE	3,5x140	100	7.000
5314/C TE	3,5x200	100	7.000
5315/C TE	4,8x200	100	4.000
5317 TE	4,5x290	100	3.500
5327 TE	7,5x365	100	1.500

SELF-EXTINGUISHING CABLE TIES

page 25

Code	Dimensions (mm)	Pack pcs.	Outer Carton pcs.
White			
5203/C VOE	2,5x98	100	15.000
5209/C VOE	3,5x140	100	7.000
5214/C VOE	3,5x200	100	7.000
5215/C VOE	4,8x200	100	4.000
5217 VOE	4,5x290	100	3.500
5227 VOE	7,5x365	100	1.500

DETECTABLE CABLE TIES

page 26

Code	Dimensions (mm)	Pack pcs.	Outer Carton pcs.
Blue			
5203/C DTE	2,5x98	100	15.000
5209/C DTE	3,5x140	100	7.000
5214/C DTE	3,5x200	100	7.000
5215/C DTE	4,5x200	100	4.000
5217 DTE	4,5x290	100	3.500
5219 DTE	4,5x360	100	3.000
5227 DTE	7,5x365	100	1.500

COLOURED CABLE TIES

page 27

Code	Dimensions (mm)	Pack pcs.	Outer Carton pcs.
Red			
5203/C RE	2,5x98	100	15.000
5209/C RE	3,5x140	100	7.000
5214/C RE	3,5x200	100	7.000
5215/C RE	4,8x200	100	4.000
5217 RE	4,5x290	100	3.500
Yellow			
5203/C GE	2,5x98	100	15.000
5209/C GE	3,5x140	100	7.000
5214/C GE	3,5x200	100	7.000
5215/C GE	4,8x200	100	4.000
5217 GE	4,5x290	100	3.500
Green			
5203/C VE	2,5x98	100	15.000
5209/C VE	3,5x140	100	7.000
5214/C VE	3,5x200	100	7.000
5215/C VE	4,8x200	100	4.000
5217 VE	4,5x290	100	3.500
Blue			
5203/C BE	2,5x98	100	15.000
5209/C BE	3,5x140	100	7.000
5214/C BE	3,5x200	100	7.000
5215/C BE	4,8x200	100	4.000
5217 BE	4,5x290	100	3.500

IDENTIFICATION CABLE TIES

with trasversal plate

page 28

Code	Dimensions (mm)	Pack pcs.	Outer Carton pcs.
Natural			
52100-ME	2,5x100	100	10.000
52200-ME	2,5x200	100	7.500

IDENTIFICATION CABLE TIES

with internal longitudinal plate

page 28

Code	Dimensions (mm)	Pack pcs.	Outer Carton pcs.
Natural			
52190-ME	4,8x190	100	5.000
52270-ME	4,8x270	100	4.000

IDENTIFICATION CABLE TIES

with external cross plate

page 28

Code	Dimensions (mm)	Pack pcs.	Outer Carton pcs.
Natural			
52110-ME	2,5x110	100	10.000
52210-ME	2,5x210	100	10.000

FIXING CABLE TIES

page 29

Code	Dimensions (mm)	Pack pcs.	Outer Carton pcs.
Natural			
52155-ME	3,5x150	100	7.500
52199-ME	3,5x200	100	5.000
52205-ME	4,5x200	100	5.000
Natural			
52150-IE	3,5x150	100	10.000
52200-IE	3,5x200	100	5.000
52150-SE	4,5x150	100	7.500
52200-SE	4,5x200	100	5.000
52200-HE	7,5x200	100	3.000
52300-HE	7,5x300	100	2.000
52380-HE	7,5x380	100	2.000

RELEASABLE CABLE TIES

page 30

Code	Dimensions (mm)	Pack pcs.	Outer Carton pcs.
Natural			
5250E	7,5x200	100	6.000
5252E	7,5x250	100	4.000
5254E	7,5x350	100	3.500
Black			
5350E	7,5x200	100	6.000
5352E	7,5x250	100	4.000
5354E	7,5x350	100	3.500

STAINLESS STEEL CABLE TIES

COLSTEEL CABLE TIES

in inox stainless steel aisi 304-316

page 33

Code	Dimensions (mm)	Pack pcs.	Outer Carton pcs.
------	--------------------	--------------	----------------------

AISI 304

6701	4,6x127	100	1.000
6703	4,6x201	100	1.000
6706	4,6x266	100	1.000
6708	4,6x362	100	1.000
6710	4,6x521	50	500
6712	4,6x838	50	500
6719	7,9x201	100	500
6720	7,9x266	100	500
6722	7,9x362	100	500
6724	7,9x521	50	500
6726	7,9x838	50	500
6728	7,9x1.067	50	1.000

AISI 316

6753	4,6x201	100	1.000
6756	4,6x266	100	1.000
6758	4,6x362	100	1.000
6760	4,6x521	50	500
6769	7,9x201	100	500
6770	7,9x266	100	500
6772	7,9x362	100	500

ACCESSORIES FOR CABLE TIES FIXING

ANCHORING BASE FOR CABLE TIES

page 34

Code	Dimensions (mm)	Pack pcs.	Outer Carton pcs.
------	--------------------	--------------	----------------------

Black

5456 AE	7,8x37x9,6	100	5.000
5458E	10x43,5x9,7	100	5.000
5458 AE	10x43,5x9,7	100	5.000
5459E	10x50x9,7	100	5.000

THREADED FIXING BASE FOR CABLE TIES

page 35

Code	Dimensions (mm)	Pack pcs.	Outer Carton pcs.
------	--------------------	--------------	----------------------

Black

1041301E	M6/7 - 9 (cable tie width)	100	8.000
-----------------	-------------------------------	-----	-------

FIXING CRADLE

page 36

Code	Dimensions (mm)	Pack pcs.	Outer Carton pcs.
------	--------------------	--------------	----------------------

Natural

104300	8,1 (cable tie width)	100	17.000
---------------	-----------------------	-----	--------

MOUNTING BASE

page 36

Code	Dimensions (mm)	Pack pcs.	Outer Carton pcs.
------	--------------------	--------------	----------------------

Natural

5498	5 (cable tie width)	100	10.000
5496E	9,3 (cable tie width)	100	5.000

Black

5499	5 (cable tie width)	100	10.000
5497E	9,3 (cable tie width)	100	5.000

SCREW FIXING MOUNTS

page 37

Code	Dimensions (mm)	Pack pcs.	Outer Carton pcs.
------	--------------------	--------------	----------------------

Natural

5460E	4,8 (cable tie width)	100	10.000
--------------	-----------------------	-----	--------

TWO-WAY MOUNTING BASES

without adhesive

page 39

Code	Dimensions (mm)	Pack pcs.	Outer Carton pcs.
------	--------------------	--------------	----------------------

Natural

5472E	27x27x4,8	100	5.000
--------------	-----------	-----	-------

Black

5474E	27x27x4,8	100	5.000
--------------	-----------	-----	-------

TWO-WAY MOUNTING BASES

with rubber base adhesive

page 39

Code	Dimensions (mm)	Pack pcs.	Outer Carton pcs.
------	--------------------	--------------	----------------------

Natural

5467 RBE	19x19x3,6	100	15.000
5473 RBE	27x27x4,8	100	6.000

Black

5469 RBE	19x19x3,6	100	15.000
5475 RBE	27x27x4,8	100	6.000

TWO-WAY MOUNTING BASES

with acrylic base adhesive

page 39

Code	Dimensions (mm)	Pack pcs.	Outer Carton pcs.
------	--------------------	--------------	----------------------

Natural

5467 3MVE	19x19x3,6	100	15.000
5473 3MVE	27x27x4,8	100	6.000

Black

5469 3MVE	19x19x3,6	100	15.000
5475 3MVE	27x27x4,8	100	6.000

DETECTABLE TWO-WAY MOUNTING BASES

with rubber base adhesive

page 40

Code	Dimensions (mm)	Pack pcs.	Outer Carton pcs.
------	--------------------	--------------	----------------------

Blue

5473DT RBE	27x27x4,8	100	6.000
-------------------	-----------	-----	-------

SELF-ADHESIVE FIXING CLIPS FOR ROUND CABLES

with rubber base adhesive

page 41

Code	Dimensions (mm)	Pack pcs.	Outer Carton pcs.
------	--------------------	--------------	----------------------

Natural

5430 RBE	19x19x5	100	12.000
5432 RBE	26x26x8	100	5.000
5436 RBE	26x26x15	100	3.000

Black

5431 RBE	19x19x5	100	12.000
5433 RBE	26x26x8	100	5.000
5439 RBE	26x26x15	100	3.000

SELF-ADHESIVE FIXING CLIPS FOR ROUND CABLES

with acrylic base adhesive

page 41

Code	Dimensions (mm)	Pack pcs.	Outer Carton pcs.
------	--------------------	--------------	----------------------

Natural

5430 3MVE	19x19x5	100	12.000
5432 3MVE	26x26x12	100	5.000
5436 3MVE	26x26x15	100	3.000

SELF-ADHESIVE FIXING CLIPS FOR FLAT CABLES

with rubber base adhesive

page 42

Code	Dimensions (mm)	Pack pcs.	Outer Carton pcs.
------	--------------------	--------------	----------------------

White

AFC-20	20x26x9,6	100	5.000
AFC-25	25x26x9,6	100	5.000
AFC-30	30x26x9,6	50	3.500

CABLE CLIPS

for round cable

page 43

Code	Dimensions (mm)	Pack pcs.	Outer Carton pcs.
White			
13620004	4	100	-
13620005	5	100	-
13620006	6	100	-
13620007	7	100	-
13620008	8	100	-
13620009	9	100	-
13620010	10	100	-

TERMINAL BLOCKS

E-BLOKS SINGLE POLE TERMINAL BLOCKS

page 47

Code	Section x N. poles (mm ²)	Pack pcs.	Outer Carton pcs.
EBS 15	1,5x10	25	450
EBS 25	2,5x10	25	450
EBS 40	4x10	25	450
EBS 60	6x10	25	450
EBS 100	10x10	10	300
EBS 160	16x5	10	240
EBS 250	25x1	5	150
EBS 350	35x1	5	150

MULTI-WAY TERMINAL BLOCKS

in neutral polyamide, 12 poles

page 48

Code	Section (mm ²)	Pack pcs.	Outer Carton pcs.	N
EMPA 15	1,5	10	300	
EMPA 25	2,5	10	200	
EMPA 40	4	10	120	
EMPA 100	10	10	60	
EMPA 160	16	10	30	SR

MULTI-WAY TERMINAL BLOCKS

in neutral polyethylene, 12 poles

page 48

Code	Section (mm ²)	Pack pcs.	Outer Carton pcs.
EMPP 25	2,5	10	300
EMPP 40	4	10	200
EMPP 60	6	10	100
EMPP 100	10	10	80
EMPP 160	16	10	60

END-SLEEVES

NON-INSULATED END SLEEVES

page 49

Code	Section x Length (mm ²) x (mm)	Pack pcs.	Outer Carton pcs.
11001031	1 x 6	500	-
11001032	1 x 10	500	-
11001041	1,5 x 7	500	-
11001042	1,5 x 10	500	-
11001051	2,5 x 7	500	-
11001052	2,5 x 10	500	-
11001061	4 x 9	500	-
11001062	4 x 12	500	-
11001071	6 x 12	100	-
11001072	6 x 15	100	-
11001081	10 x 12	100	-
11001082	10 x 15	100	-
11001092	16 x 15	100	-
11001093	16 x 18	100	-
11001101	25 x 15	50	-
11001111	35 x 18	50	-
11001122	50 x 25	50	-

INSULATED END-SLEEVES FOR SINGLE CABLE

50 pieces strips

page 50

Code	Section - Colour (mm ²)	Pack pcs.	Outer Carton pcs.
E02B	0,50/N white - T	500	-
E05B	0,75/N blue - T	500	-
E09B	1,00/N red - T	500	-
E13B	1,50/N black - T	500	-
E16B	2,50/N grey - T	500	-

INSULATED END-SLEEVES

page 51

Code	Section - Colour (mm ²)	Pack pcs.	Outer Carton pcs.	N
E034	0,25/N violet - T	500	-	
E134	0,25/N light blue - W	500	-	
E036	0,34/N pink - T	500	-	
E136	0,34/N sea green - W	500	-	

Code	Section - Colour (mm ²)	Pack pcs.	Outer Carton pcs.	N
E01	0,50/K white - T/D	500	-	
E010	0,50/K orange - W	500	-	
E02	0,50/N white - T/D	500	-	
E02C	0,50/N white - T/D	100	-	
E020	0,50/N orange - W	500	-	
E04	0,75/K light blue - T	500	-	
E040	0,75/K white - W	500	- AR	
E004D	0,75/K grey - D	500	- AR	
E05	0,75/N light blue - T	500	-	
E05C	0,75/N light blue - T	100	-	
E050	0,75/N white - W	500	-	
E005D	0,75/N grey - D	500	-	
E06	0,75/HL light blue - T	500	- AR	
E060	0,75/HL white - W	500	- AR	
E006D	0,75/HL grey - D	500	- AR	
E08	1,00/K red - T	500	-	
E080	1,00/K yellow - W	500	-	
E09	1,00/N red - T	500	-	
E09C	1,00/N red - T	100	-	
E090	1,00/N yellow - W	500	-	
E10	1,00/HL red - T	500	-	
E100	1,00/HL yellow - W	500	- AR	
E13	1,50/N black - T/D	500	-	
E13C	1,50/N black - T/D	100	-	
E113	1,50/N red - W	500	-	
E14	1,50/HL black - T/D	500	-	
E114	1,50/HL red - W	500	-	
E16	2,50/N grey - T	500	-	
E16C	2,50/N grey - T	100	-	
E116	2,50/N blue - W/D	500	-	
E17	2,50/HL grey - T	500	-	
E117	2,50/HL blue - W/D	500	-	
E19	4,00/N orange - T	500	-	
E19C	4,00/N orange - T	100	-	
E119	4,00/N grey - W/D	500	-	
E20	4,00/HL orange - T	500	-	
E120	4,00/HL grey - W/D	500	-	
E22	6,00/N green - T	100	-	
E122	6,00/N black - W	100	-	
E022D	6,00/N yellow - D	100	-	
E24	10,00/N brown - T	100	-	

Code	Section - Colour (mm ²)	Pack pcs.	Outer Carton pcs.	N
E124	10,00/N cream - W	100	-	
E024D	10,00/N red - D	100	-	
E26	16,00/N cream - T	100	-	
E126	16,00/N green - W	100	-	
E026D	16,00/N blue - D	100	-	
E28	25,00/N black - T	50	-	
E128	25,00/N brown - W	50	-	
E028D	25,00/N yellow - D	50	-	
E30	35,00/N red - T/D	50	-	
E130	35,00/N grey - W	50	-	
E32	50,00/N blue - T/D	50	-	
E132	50,00/N dark green - W	50	-	

INSULATED END-SLEEVES FOR TWO CABLES

page 52

Code	Section - Colour (mm ²)	Pack pcs.	Outer Carton pcs.
11031002	2x0,50/N white - T/D	500	-
11031005 T	2x0,75/N blue - T	500	-
11031005	2x0,75/N grey - D	500	-
11031009	2x1,00/N red - T/D	500	-
11031013	2x1,50/N black - T/D	500	-
11031016 T	2x2,50/N grey - T	250	-
11031016	2x2,50/N blue - D	250	-
11031019 T	2x4,00/N orange - T	100	-
11031019	2x4,00/N grey - D	100	-
11031022 T	2x6,00/N dark green - T	100	-
11031022	2x6,00/N yellow - D	100	-
11031024 T	2x10,00/N brown - T	100	-
11031024	2x10,00/N red - D	100	-
11031026 T	2x16,00/N cream - T	50	-
11031026	2x16,00/N blue - D	50	-

ASSORTMENT OF INSULATED END-SLEEVES

end sleeves from 0,5 to 2,5 mm²

page 53

Code	Section - Colour (mm ²)	Pack pcs.	Outer Carton pcs.
11012001	0,5÷2,5 - T	1	-

ASSORTMENT OF INSULATED END-SLEEVES

end sleeves from 4 to 16 mm²

page 53

Code	Section - Colour (mm ²)	Pack pcs.	Outer Carton pcs.
11012002	4÷16 - T	1	-

INSULATED TERMINAL LUGS

NYLON RING TERMINAL

page 55

Code	Section - Colour (mm ²) x (mm)	Pack pcs.	Outer Carton pcs.
11201134	0,25÷1,5 x Ø3,2 - red	100	-
11201135	0,25÷1,5 x Ø3,7 - red	100	-
11201143	0,25÷1,5 x 4,3 - red	100	-
11201150	0,25÷1,5 x Ø5,3 - red	100	-
11201161	0,25÷1,5 x Ø6,5 - red	100	-
11201180	0,25÷1,5 x Ø8,4 - red	100	-
11201191	0,25÷1,5 x Ø10,5 - red	100	-
11201232	1,5÷2,5 x Ø3,2 - blue	100	-
11201236	1,5÷2,5 x Ø3,7 - blue	100	-
11201239	1,5÷2,5 x Ø4,3 - blue	100	-
11201250	1,5÷2,5 x Ø5,3 - blue	100	-
11201261	1,5÷2,5 x Ø6,5 - blue	100	-
11201280	1,5÷2,5 x Ø8,4 - blue	100	-
11201291	1,5÷2,5 x Ø10,5 - blue	100	-
11201295	1,5÷2,5 x Ø13 - blue	100	-
11201440	4÷6 x Ø4,3 - yellow	100	-
11201450	4÷6 x Ø5,3 - yellow	100	-
11201460	4÷6 x Ø6,5 - yellow	100	-
11201480	4÷6 x Ø8,4 - yellow	100	-
11201491	4÷6 x Ø10,5 - yellow	100	-
11201495	4÷6 x Ø13 - yellow	100	-

NYLON PIN TERMINAL

page 55

Code	Section/Dim. - Colour (mm ²) / (mm)	Pack pcs.	Outer Carton pcs.
11210112	0,25÷1,5 / 1,9x10 - red	100	-
11210115	0,25÷1,5 / 1,9x12 - red	100	-
11210212	1,5÷2,5 / 1,9x10 - blue	100	-
11210215	1,5÷2,5 / 1,9x12 - blue	100	-
11210412	4÷6 / 2,9x14 - yellow	100	-

NYLON FORK TERMINAL

page 55

Code	Section/Dim. - Colour (mm ²) / (mm)	Pack pcs.	Outer Carton pcs.
11202132	0,25÷1,5 / 3,2 - red	100	-
11202135	0,25÷1,5 / 3,7 - red	100	-
11202140	0,25÷1,5 / 4,3 - red	100	-
11202150	0,25÷1,5 / 5,3 - red	100	-
11202160	0,25÷1,5 / 6,5 - red	100	-
11202232	1,5÷2,5 / 3,2 - blue	100	-
11202240	1,5÷2,5 / 3,7 - blue	100	-
11202242	1,5÷2,5 / 4,3 - blue	100	-
11202250	1,5÷2,5 / 5,3 - blue	100	-
11202261	1,5÷2,5 / 6,5 - blue	100	-
11202440	4÷6 / 4,3 - yellow	100	-
11202450	4÷6 / 5,3 - yellow	100	-
11202460	4÷6 / 6,5 - yellow	100	-
11202480	4÷6 / 8,4 - yellow	100	-
11202490	4÷6 / 10,5 - yellow	100	-

PVC BUTT CONNECTORS

page 56

Code	Section - Colour (mm ²)	Pack pcs.	Outer Carton pcs.
11220140	0,25÷1,5 - red	100	-
11220250	1,5÷2,5 - blue	100	-
11220465	4÷6 - yellow	100	-

INSULATED NYLON END CONNECTORS

page 56

Code	Section	Pack	Outer Carton
	(mm ²)	pcs.	pcs.
ECDC-E-1	0,25÷1,5	100	-
ECDC-E-2	1,5÷2,5	100	-
ECDC-E-5	4÷6	100	-

POLYPROPYLENE RAPID CONNECTORS FOR SWITCHES, joints and terminations

page 56

Code	Section - Colour	Pack	Outer Carton
	(mm ²)	pcs.	pcs.
ESCR	0,25÷1,5 - red	100	-
ESCB	1,5÷2,5 - blue	100	-
ESCG	4÷6 - yellow	100	-

PVC FEMALE PUSH-ON TERMINALS

with copper bush

page 56

Code	Section/Dim. - Colour	Pack	Outer Carton
	(mm ²) / (mm)	pcs.	pcs.
11231128	0,25÷1,5 / 3,2x0,5 - red	100	-
11231129	0,25÷1,5 / 3,2x0,8 - red	100	-
11231150	0,25÷1,5 / 5x0,5 - red	100	-
11231149	0,25÷1,5 / 5x0,8 - red	100	-
11231163	0,25÷1,5 / 6,6x0,8 - red	100	-
11231228	1,5÷2,5 / 3,2x0,5 - blue	100	-
11231250	1,5÷2,5 / 5x0,5 - blue	100	-
11231249	1,5÷2,5 / 5x0,8 - blue	100	-
11231263	1,5÷2,5 / 6,6x0,8 - blue	100	-
11231463	4÷6 / 6,6x0,8 - blue	100	-

PVC MALE PUSH-ON TERMINALS

with copper bush

page 56

Code	Section/Dim. - Colour	Pack	Outer Carton
	(mm ²) / (mm)	pcs.	pcs.
11230128	0,25÷1,5 / 2,8x0,5 - red	100	-
11230153	0,25÷1,5 / 4,8x0,8 - red	100	-
11230163	0,25÷1,5 / 6,3x0,8 - red	100	-
11230253	1,5÷2,5 / 4,8x0,8 - blue	100	-
11230263	1,5÷2,5 / 6,3x0,8 - blue	100	-
11230463	4÷6 / 6,3x0,8 - yellow	100	-

PVC PIGGY BACK

with copper bush

page 57

Code	Section/Dim. - Colour	Pack	Outer Carton
	(mm ²) / (mm)	pcs.	pcs.
11232153	0,25÷1,5 / 6,6x0,8 - red	100	-
11232263	1,5÷2,5 / 6,6x0,8 - blue	100	-
11232463	4÷6 / 6,6x0,8 - yellow	100	-

PVC FULLY INSULATED FEMALE PUSH-ON TERMINALS

with copper bush

page 57

Code	Section/Dim. - Colour	Pack	Outer Carton
	(mm ²) / (mm)	pcs.	pcs.
11235125	0,25÷1,5 / 3,2x0,5 - red	100	-
11235128	0,25÷1,5 / 3,2x0,8 - red	100	-
11235148	0,25÷1,5 / 5x0,5 - red	100	-
11235153	0,25÷1,5 / 5x0,8 - red	100	-
11235163	0,25÷1,5 / 6,6x0,8 - red	100	-
11235248	1,5÷2,5 / 5x0,5 - blue	100	-
11235253	1,5÷2,5 / 5x0,8 - blue	100	-
11235263	1,5÷2,5 / 6,6x0,8 - blue	100	-
11235463	4÷6 / 6,6x0,8 - yellow	100	-

NYLON FULLY INSULATED MALE PUSH-ON TERMINALS

with copper bush

page 57

Code	Section/Dim. - Colour	Pack	Outer Carton
	(mm ²) / (mm)	pcs.	pcs.
11236163	0,25÷1,5 / 6,3x0,8 - red	100	-
11236263	1,5÷2,5 / 6,3x0,8 - blue	100	-
11236463	4÷6 / 6,3x0,8 - yellow	100	-

PVC MALE BULLETS TERMINALS

with copper bush

page 57

Code	Section/Dim. - Colour	Pack	Outer Carton
	(mm ²) / (mm)	pcs.	pcs.
11240148	0,25÷1,5 / 4 - red	100	-
11240248	1,5÷2,5 / 4 - blue	100	-
11240448	4÷6 / 5 - yellow	100	-

PVC FEMALE SOCKET TERMINALS

with copper bush

page 57

Code	Section/Dim. - Colour	Pack	Outer Carton
	(mm ²) / (mm)	pcs.	pcs.
11241148	0,25÷1,5 / 4 / red	100	-
11241248	1,5÷2,5 / 4 / blue	100	-
11241448	4÷6 / 5 / yellow	100	-

JOINT CONNECTORS HEAT SHRINKING INSULATION

page 57

Code	Section/Dim. - Colour	Pack	Outer Carton
	(mm ²) / (mm)	pcs.	pcs.
11221140	0,25÷1,5 / 5,4 / red	100	-
11221250	1,5÷2,5 / 5,8 / blue	100	-
11221465	4÷6 / 6 / yellow	100	-

INSULATED TERMINAL LUGS

NON-INSULATED TUBULAR LUGS

from 1,5 to 300 mm²

page 60

Code	Section - hole	Pack	Outer Carton
	(mm ²) - (mm)	pcs.	pcs.
11301005	1,5 - Ø6	100	2.000
11301008	2,5 - Ø4	100	2.000
11301010	2,5 - Ø6	100	1.500
11301013	4 - Ø6	100	1.000
11301014	4 - Ø8	100	1.000
11301016	6 - Ø5	100	1.000
11301018	6 - Ø6	100	1.000
11301019	6 - Ø8	100	800
11301022	10 - Ø5	100	700
11301023	10 - Ø6	100	600
11301024	10 - Ø8	100	500
11301025	10 - Ø10	100	500
11301028	16 - Ø5	100	500
11301029	16 - Ø6	100	500
11301030	16 - Ø8	100	500
11301031	16 - Ø10	100	400
11301032	16 - Ø12	100	300
11301036	25 - Ø6	50	600
11301037	25 - Ø8	50	500
11301038	25 - Ø10	50	500
11301039	25 - Ø12	50	500
11301041	35 - Ø6	50	400
11301042	35 - Ø8	50	400
11301043	35 - Ø10	50	350
11301044	35 - Ø12	50	300
11301051	50 - Ø6	20	240

Code	Section - hole	Pack	Outer Carton
	(mm ²) - (mm)	pcs.	pcs.
11301052	50 - Ø8	20	240
11301053	50 - Ø10	20	200
11301054	50 - Ø12	20	200
11301055	50 - Ø14	20	200
11301064	70 - Ø8	20	160
11301065	70 - Ø10	20	160
11301066	70 - Ø12	20	160
11301067	70 - Ø14	20	120
11301075	95 - Ø8	20	120
11301076	95 - Ø10	20	120
11301077	95 - Ø12	20	120
11301078	95 - Ø14	20	120
11301086	120 - Ø8	10	80
11301087	120 - Ø10	10	80
11301088	120 - Ø12	10	80
11301089	120 - Ø14	10	80
11301097	150 - Ø10	10	70
11301098	150 - Ø12	10	70
11301099	150 - Ø14	10	70
11301107	185 - Ø12	10	50
11301108	185 - Ø14	10	50
11301109	185 - Ø16	10	50
11301116	240 - Ø12	5	40
11301117	240 - Ø14	5	40
11301118	240 - Ø16	5	40
11301123	300 - Ø16	5	30

COPPER PIN TERMINAL

from 10 to 50 mm² page 61

Code	Section-Length	Pack	Outer Carton
	(mm ²) - (mm)	pcs.	pcs.
11307010	10 - 24,1	100	1.000
11307016	16 - 31	100	600
11307025	25 - 38	100	400
11307035	35 - 43,4	100	200
11307050	50 - 50,5	50	150

COPPER BUTT TUBE TERMINAL

from 6 to 300 mm² page 61

Code	Section-Length	Pack	Outer Carton
	(mm ²) - (mm)	pcs.	pcs.
11308003	6 - 25,5	100	1.000
11308004	10 - 30	100	600
11308005	16 - 32,5	100	400
11308007	25 - 35,5	100	500
11308008	35 - 40,5	50	300
11308009	50 - 40,5	20	260
11308010	70 - 45,5	20	140
11308011	95 - 50,5	20	100
11308012	120 - 65,5	10	90
11308013	150 - 70,5	10	70
11308014	185 - 75,5	10	50
11308015	240 - 80,5	5	40

Code	Section-Length	Pack	Outer Carton
	(mm ²) - (mm)	pcs.	pcs.
11308016	300 - 90,5	5	15

HEAT SHRINK TUBE

EV 100

heat shrink tube 2:1 - reel page 67

Code	Ø internal expanded/recovered	Pack	Outer carton
	(mm)		
black			
12201016	1,6 / 0,8	200	-
12201024	2,4 / 1,2	200	-
12201032	3,2 / 1,6	200	-
12201048	4,8 / 2,4	200	-
12201064	6,4 / 3,2	150	-
12201095	9,5 / 4,7	150	-
12201127	12,7 / 6,4	100	-
12201190	19,1 / 9,5	50	-
12201254	25,4 / 12,7	50	-
12201381	38,1 / 19,1	25	-
12201508	50,8 / 25,4	25	-

EV 100

heat shrink tube 2:1 - box page 67

Code	Ø internal expanded/recovered	Pack	Outer carton
	(mm)		
black			
12251016	1,6 / 0,8	15	-
12251024	2,4 / 1,2	15	-
12251032	3,2 / 1,6	15	-
12251048	4,8 / 2,4	12	-
12251064	6,4 / 3,2	12	-
12251095	9,5 / 4,7	10	-
12251127	12,7 / 6,4	8	-
12251190	19,1 / 9,5	5	-
12251254	25,4 / 12,7	3	-

EV 100

heat shrink tube 2:1 - 1 metre tubing - box page 67

Code	Ø internal expanded/recovered	Pack	Outer carton
	(mm)		
black			
12271016	1,6 / 0,8	30	-
12271024	2,4 / 1,2	30	-
12271032	3,2 / 1,6	30	-
12271048	4,8 / 2,4	24	-
12271064	6,4 / 3,2	24	-
12271095	9,5 / 4,7	20	-
12271127	12,7 / 6,4	16	-
12271190	19,1 / 9,5	10	-

Code	Ø internal expanded/recovered	Pack	Outer carton
	(mm)		
12271254	25,4 / 12,7	6	-

ET 100

heat shrink tube 2:1 - reel
Self-extinguishing UL224

page 69

Code	Ø internal expanded/recovered	Pack	Outer carton
	(mm)		
black			
12203012	1,2 / 0,6	200	-
12203016	1,6 / 0,8	200	-
12203024	2,4 / 1,2	200	-
12203032	3,2 / 1,6	200	-
12203048	4,8 / 2,4	200	-
12203064	6,4 / 3,2	150	-
12203095	9,5 / 4,7	150	-
12203127	12,7 / 6,4	100	-
12203190	19,1 / 9,5	50	-
12203254	25,4 / 12,7	50	-
12203381	38,1 / 19,1	25	-
12203508	50,8 / 25,4	25	-
12203762	76,2 / 38,1	15	-
12203994	101,6 / 50,8	15	-

Yellow/green

12203024 G/V	2,4 / 1,2	200	-
12203032 G/V	3,2 / 1,6	200	-
12203048 G/V	4,8 / 2,4	200	-
12203064 G/V	6,4 / 3,2	150	-
12203095 G/V	9,5 / 4,8	150	-
12203127 G/V	12,7 / 6,4	100	-
12203190 G/V	19,1 / 9,5	50	-
12203254 G/V	25,4 / 12,7	50	-
12203381 G/V	38,1 / 19,1	25	-
12203508 G/V	50,8 / 25,4	25	-

ET 100

heat shrink tube 2:1 - box
Self-extinguishing UL224

page 69

Code	Ø internal expanded/recovered	Pack	Outer carton
	(mm)		
black			
12253012	1,2 / 0,6	15	-
12253016	1,6 / 0,8	15	-
12253024	2,4 / 1,2	15	-
12253032	3,2 / 1,6	15	-
12253048	4,8 / 2,4	12	-
12253064	6,4 / 3,2	12	-
12253095	9,5 / 4,7	10	-
12253127	12,7 / 6,4	8	-
12253190	19,1 / 9,5	5	-
12253254	25,4 / 12,7	3	-

Code	Ø internal expanded/recovered (mm)	Pack (m)	Outer carton (m)
Yellow/green			
12253024 G/V	2,4 / 1,2	15	-
12253032 G/V	3,2 / 1,6	15	-
12253048 G/V	4,8 / 2,4	12	-
12253064 G/V	6,4 / 3,2	12	-
12253095 G/V	9,5 / 4,8	10	-
12253127 G/V	12,7 / 6,4	8	-
12253190 G/V	19,1 / 9,5	5	-
12253254 G/V	25,4 / 12,7	3	-
White			
12253012 BI	1,2 / 0,6	15	-
12253024 BI	2,4 / 1,2	15	-
12253032 BI	3,2 / 1,6	15	-
12253048 BI	4,8 / 2,4	12	-
12253064 BI	6,4 / 3,2	12	-
12253095 BI	9,5 / 4,8	10	-
12253127 BI	12,7 / 6,4	8	-
12253190 BI	19,1 / 9,5	5	-
12253254 BI	25,4 / 12,7	3	-
Blue			
12253016 BL	1,6 / 0,8	15	-
12253024 BL	2,4 / 1,2	15	-
12253032 BL	3,2 / 1,6	15	-
12253048 BL	4,8 / 2,4	12	-
12253064 BL	6,4 / 3,2	12	-
12253095 BL	9,5 / 4,8	10	-
12253127 BL	12,7 / 6,4	8	-
12253190 BL	19,1 / 9,5	5	-
12253254 BL	25,4 / 12,7	3	-
Red			
12253012 R	1,2 / 0,6	15	-
12253016 R	1,6 / 0,8	15	-
12253024 R	2,4 / 1,2	15	-
12253032 R	3,2 / 1,6	15	-
12253048 R	4,8 / 2,4	12	-
12253064 R	6,4 / 3,2	12	-
12253095 R	9,5 / 4,8	10	-
12253127 R	12,7 / 6,4	8	-
12253190 R	19,1 / 9,5	5	-
12253254 R	25,4 / 12,7	3	-
Trasparent			
12253024 TR	2,4 / 1,2	15	-
12253032 TR	3,2 / 1,6	15	-
12253048 TR	4,8 / 2,4	12	-
12253064 TR	6,4 / 3,2	12	-
12253095 TR	9,5 / 4,8	10	-
12253127 TR	12,7 / 6,4	8	-
12253190 TR	19,1 / 9,5	5	-
12253254 TR	25,4 / 12,7	3	-

ET 100

heat shrink tube 2:1 - 1 metre tubing - box
Self-extinguishing UL224 page 69

Code	Ø internal expanded/recovered (mm)	Pack (m)	Outer carton (m)
black			
12273012	1,2 / 0,6	30	-
12273016	1,6 / 0,8	30	-
12273024	2,4 / 1,2	30	-
12273032	3,2 / 1,6	30	-
12273048	4,8 / 2,4	24	-
12273064	6,4 / 3,2	24	-
12273095	9,5 / 4,8	20	-
12273127	12,7 / 6,4	16	-
12273190	19,1 / 9,5	10	-
12273254	25,4 / 12,7	6	-
12273381	38,1 / 19,1	4	-
12273508	50,8 / 25,4*	3	-
12273762	76,2 / 38,1*	3	-
12273994	101,6 / 50,8*	3	-
Yellow/green			
12273012 G/V	1,2 / 0,6	30	-
12273016 G/V	1,6 / 0,8	30	-
12273024 G/V	2,4 / 1,2	30	-
12273032 G/V	3,2 / 1,6	30	-
12273048 G/V	4,8 / 2,4	24	-
12273064 G/V	6,4 / 3,2	24	-
12273095 G/V	9,5 / 4,8	20	-
12273127 G/V	12,7 / 6,4	16	-
12273190 G/V	19,1 / 9,5	10	-
12273254 G/V	25,4 / 12,7	6	-
12273381 G/V	38,1 / 19,1	4	-
12273508 G/V	50,8 / 25,4*	3	-
White			
12273012 BI	1,2 / 0,6	30	-
12273016 BI	1,6 / 0,8	30	-
12273024 BI	2,4 / 1,2	30	-
12273032 BI	3,2 / 1,6	30	-
12273048 BI	4,8 / 2,4	24	-
12273064 BI	6,4 / 3,2	24	-
12273095 BI	9,5 / 4,8	20	-
12273127 BI	12,7 / 6,4	16	-
12273190 BI	19,1 / 9,5	10	-
12273254 BI	25,4 / 12,7	6	-
12273381 BI	38,1 / 19,1	4	-
12273508 BI	50,8 / 25,4*	3	-
Blue			
12273012 BL	1,2 / 0,6	30	-
12273016 BL	1,6 / 0,8	30	-
12273024 BL	2,4 / 1,2	30	-
12273032 BL	3,2 / 1,6	30	-
12273048 BL	4,8 / 2,4	24	-
12273064 BL	6,4 / 3,2	24	-
12273095 BL	9,5 / 4,8	20	-
12273127 BL	12,7 / 6,4	16	-
12273190 BL	19,1 / 9,5	10	-

Code	Ø internal expanded/recovered (mm)	Pack (m)	Outer carton (m)
12273254 BL	25,4 / 12,7	6	-
12273381 BL	38,1 / 19,1	4	-
12273508 BL	50,8 / 25,4*	3	-
Red			
12273012 R	1,2 / 0,6	30	-
12273016 R	1,6 / 0,8	30	-
12273024 R	2,4 / 1,2	30	-
12273032 R	3,2 / 1,6	30	-
12273048 R	4,8 / 2,4	24	-
12273064 R	6,4 / 3,2	24	-
12273095 R	9,5 / 4,8	20	-
12273127 R	12,7 / 6,4	16	-
12273190 R	19,1 / 9,5	10	-
12273254 R	25,4 / 12,7	6	-
12273381 R	38,1 / 19,1	4	-
12273508 R	50,8 / 25,4*	3	-
Trasparent			
12273012 TR	1,2 / 0,6	30	-
12273016 TR	1,6 / 0,8	30	-
12273024 TR	2,4 / 1,2	30	-
12273032 TR	3,2 / 1,6	30	-
12273048 TR	4,8 / 2,4	24	-
12273064 TR	6,4 / 3,2	24	-
12273095 TR	9,5 / 4,8	20	-
12273127 TR	12,7 / 6,4	16	-
12273190 TR	19,1 / 9,5	10	-
12273254 TR	25,4 / 12,7	6	-
12273381 TR	38,1 / 19,1	4	-
12273508 TR	50,8 / 25,4*	3	-

*Packed in plastic bag

ET 100 ASSORTMENT DISPLAY

1 m heat shrink tube boxes page 71

Code	Ø internal expanded/recovered (mm)	Pack (m)	Outer carton (m)	N
KIT 8221705				
-				
Composition				
12273016	1,6 / 0,8	30	-	-
12273024	2,4 / 1,2	30	-	-
12273032	3,2 / 1,6	30	-	-
12273048	4,8 / 2,4	24	-	-
12273064	6,4 / 3,2	24	-	-
12273095	9,5 / 4,8	20	-	-
12273127	12,7 / 6,4	16	-	-
12273190	19,1 / 9,5	10	-	-
12273254	25,4 / 12,7	6	-	-
12273048 G/V	4,8 / 2,4	24	-	-
12273064 G/V	6,4 / 3,2	24	-	-
12273095 G/V	9,5 / 4,8	20	-	-
12273127 G/V	12,7 / 6,4	16	-	-

Code	Ø internal expanded/recovered (mm)	Pack (m)	Outer carton (m)	N
12273190 G/V	19,1/9,5	10	-	-
12273048 BL	4,8/2,4	24	-	-
12273064 BL	6,4/3,2	24	-	-
12273095 BL	9,5/4,8	20	-	-
12273127 BL	12,7/6,4	16	-	-
12273190 BL	19,1/9,5	10	-	-
12273048 R	4,8/2,4	24	-	-
12273064 R	6,4/3,2	24	-	-
12273095 R	9,5/4,8	20	-	-
12273127 R	12,7/6,4	16	-	-
12273190 R	19,1/9,5	10	-	-

EL 100

heat shrink tube 2:1 - reel
Self-extinguishing UL224 VW-1
page 73

Code	Ø internal expanded/recovered (mm)	Pack (m)	Outer carton (m)
black			
12204016	1,6 / 0,8	200	-
12204024	2,4 / 1,2	200	-
12204032	3,2 / 1,6	200	-
12204048	4,8 / 2,4	200	-
12204064	6,4 / 3,2	150	-
12204095	9,5 / 4,7	150	-
12204127	12,7 / 6,4	100	-
12204190	19,1 / 9,5	50	-
12204254	25,4 / 12,7	50	-
12204381	38,1 / 19,1	25	-
12204508	50,8 / 25,4	25	-
12204762	76,2 / 38,1	15	-
12204994	101,6 / 50,8	15	-

EL 100

heat shrink tube 2:1 - box
Self-extinguishing UL224 VW-1
page 73

Code	Ø internal expanded/recovered (mm)	Pack (m)	Outer carton (m)
black			
12254016	1,6 / 0,8	15	-
12254024	2,4 / 1,2	15	-
12254032	3,2 / 1,6	15	-
12254048	4,8 / 2,4	12	-
12254064	6,4 / 3,2	12	-
12254095	9,5 / 4,7	10	-
12254127	12,7 / 6,4	8	-
12254190	19,1 / 9,5	5	-
12254254	25,4 / 12,7	3	-

ET 301

heat shrink tube 3:1 - reel
Self-extinguishing UL224
page 75

Code	Ø internal expanded/recovered (mm)	Pack (m)	Outer carton (m)
black			
12205015	1,5 / 0,5	200	-
12205030	3 / 1	200	-
12205060	6 / 2	150	-
12205090	9 / 3	150	-
12205120	12 / 4	100	-
12205180	18 / 6	50	-
12205240	24 / 8	50	-
12205390	39 / 13	30	-

ET 301

heat shrink tube 3:1 - box
Self-extinguishing UL224
page 75

Code	Ø internal expanded/recovered (mm)	Pack (m)	Outer carton (m)
black			
12255015	1,5 / 0,5	15	-
12255030	3 / 1	15	-
12255060	6 / 2	10	-
12255090	9 / 3	8	-
12255120	12 / 4	7	-
12255180	18 / 6	4	-
12255240	24 / 8	3	-

ET 301

heat shrink tube 3:1 - 1 m tube box
Self-extinguishing UL224
page 75

Code	Ø internal expanded/recovered (mm)	Pack (m)	Outer carton (m)
black			
12275015	1,5 / 0,5	30	-
12275030	3 / 1	30	-
12275060	6 / 2	24	-
12275090	9 / 3	20	-
12275120	12 / 4	16	-
12275180	18 / 6	10	-
12275240	24 / 8	6	-
12275390	39 / 13*	4	-

ASSORTIBOX ET 100

page 76

Code	Description	Pack (pcs.)	Outer carton (pcs.)
12233001	Assortibox ET 100 + multifunctional gas tool	1	-

ASSORTIBOX ET 301

page 77

Code	Description	Pack (pcs.)	Outer carton (pcs.)
12235001	Assortibox ET 301 + multifunctional gas tool	1	-

EL 301A

heat shrink tube 3:1 - box
Self-extinguishing
page 79

Code	Ø internal expanded/recovered (mm)	Pack (m)	Outer carton (m)
black			
12256030	3 / 1	15	-
12256060	6 / 2	12	-
12256090	9 / 3	10	-
12256120	12 / 4	8	-
12256180	18 / 6	5	-
12256240	24 / 8	3	-

EL 301A

heat shrink tube 3:1 - 1 m tube box
Self-extinguishing
page 79

Code	Ø internal expanded/recovered (mm)	Pack (m)	Outer carton (m)
black			
12276030	3 / 1	30	-
12276060	6 / 2	24	-
12276090	9 / 3	20	-
12276120	12 / 4	16	-
12276180	18 / 6	10	-
12276240	24 / 8	6	-

EM 100A

heat shrink tube 4:1 with liner adhesive
- 1 m tube box
page 80

Code	Ø internal expanded/recovered (mm)	Pack (m)	Outer carton (m)
black			
12247012	12 / 3	25	-
12247019	22 / 6	15	-
12247030	33 / 8	10	-
12247040	40 / 12	5	-
12247050	55 / 17	3	-
12247063	65 / 19	3	-
12247070	72 / 22	2	-
12247095	92 / 26	1	-
12247115	115 / 35	1	-
12247140	180 / 60	1	-

NEOPRENE SLEEVES

NEOPRENE SLEEVES

page 81

Code	Name - internal Ø x max. length	Pack	Outer carton
	(mm)	(m)	(m)
5381	A1 - 1,75x20	1.000	-
5382	A1K - 2,5x25	1.000	-
5383	A2 - 3x25	1.000	-
5384	A2K - 4x30	1.000	-
5385	A3 - 5x25	1.000	-
5386	A4 - 7,5x30	1.000	-
5387	A5 - 10x35	500	-
5388	A8 - 12x50	500	-
5390	A10 - 17x50	500	-

PVC SLEEVES

PVC SLEEVES

page 82

Code	internal Ø x thickness	Pack	Outer carton
	(mm)	(m)	(m)
12370300	3 x 0,3	200	-
12370400	4 x 0,3	200	-
12370500	5 x 0,4	200	-
12370600	6 x 0,4	200	-
12370700	7 x 0,4	200	-
12370800	8 x 0,4	200	-
12370101	10 x 0,5	200	-
12370121	12 x 0,5	100	-
12370141	14 x 0,6	100	-
12370161	16 x 0,6	100	-
12370181	18 x 0,7	100	-
12370202	20 x 0,8	100	-
12370222	22 x 0,9	100	-
12370242	24 x 0,9	50	-
12370262	26 x 0,9	50	-
12370282	28 x 1	50	-
12370303	30 x 1	50	-
12370404	40 x 1,2	25	-
12370505	50 x 1,3	25	-

SPIRALS

POLYETHYLENE SPIRAL

page 83

Code	Ø min ÷ max	Pack	Outer carton
	(mm)	(m)	(m)
Natural			
SP 2	3÷15	50	1.000
SP 4	4÷20	25	500
SP 6	7÷40	25	500

Code	Ø min ÷ max	Pack	Outer carton
	(mm)	(m)	(m)
SP 9	9÷50	25	350
SP 12	11÷70	25	250
SP 15	13÷80	20	200
SP 20	18÷120	25	100
SP 25	23÷150	20	80
black			
SP 2N	3÷15	50	1.000
SP 4N	4÷20	25	500
SP 6N	7÷40	25	500
SP 9N	9÷50	25	350
SP 12N	11÷70	25	250
SP 15N	13÷80	20	200
SP 20N	18÷120	25	100
SP 25N	23÷150	20	80

BRAIDED SLEEVE

POLYESTER BRAIDED SLEEVE

page 85

Code	Ø nominal	Pack	Outer carton
	(mm)	(m)	(m)
Grey			
15501006	6	100	-
15501008	8	100	-
15501010	10	100	-
15501012	12	50	-
15501015	15	50	-
15501018	18	50	-
15501020	20	50	-
15501025	25	50	-
15501030	30	50	-
15501040	40	50	-
Black			
15502006	6	100	-
15502008	8	100	-
15502010	10	100	-
15502012	12	50	-
15502015	15	50	-
15502018	18	50	-
15502020	20	50	-
15502025	25	50	-
15502030	30	50	-
15502040	40	50	-

POLYAMIDE BRAIDED SLEEVE

page 85

Code	Ø nominal	Pack	Outer carton
	(mm)	(m)	(m)
Grey			
15510006	6	100	-
15510008	8	100	-
15510010	10	100	-

Code	Ø nominal	Pack	Outer carton
	(mm)	(m)	(m)
15510012	12	50	-
15510014	14	50	-
15510016	16	50	-
15510018	18	50	-
15510020	20	50	-
15510025	25	50	-
15510030	30	50	-
15510035	35	50	-
15510040	40	50	-

INSULATION TAPE

PVC INSULATION TAPE

thickness 0,13 mm

page 87

Code	WidthxLength - colour	Pack	Outer carton
	(mm x m)	(pcs.)	(pcs.)
NI 20N	15 x 10 - black	10	200
NI 20BI	15 x 10 - white	10	200
NI 20BL	15 x 10 - blue	10	200
NI 20GI	15 x 10 - yellow	10	200
NI 20GR	15 x 10 - grey	10	200
NI 20R	15 x 10 - red	10	200
NI 20T	15 x 10 - yellow/green	10	200
NI 20V	15 x 10 - green	10	200
NI 20M	15 x 10 - brown	10	200
NI 22N	19 x 25 - black	10	120
NI 22BI	19 x 25 - white	10	120
NI 22BL	19 x 25 - blue	10	120
NI 22GI	19 x 25 - yellow	10	120
NI 22GR	19 x 25 - grey	10	120
NI 22R	19 x 25 - red	10	120
NI 22T	19 x 25 - yellow/green	10	120
NI 22V	19 x 25 - green	10	120
NI 22M	19 x 25 - brown	10	120
NI 21N	15 x 25 - black	12	144
NI 23N	19 x 10 - black	10	200
NI 24N	25 x 25 - black	8	96
NI 26N	38 x 25 - black	5	60
NI 27N	50 x 10 - black	4	60
NI 28N	50 x 25 - black	4	48

PVC INSULATION TAPE

thickness 0,15 mm

page 87

Code	WidthxLength - colour	Pack	Outer carton
	(mm x m)	(pcs.)	(pcs.)
NI 14N	15 x 10 - black	10	200

Code	WidthxLength - colour	Pack	Outer carton
	[mm x m]	[pcs.]	[pcs.]
NI 14BI	15 x 10 - white	10	200
NI 14BL	15 x 10 - blue	10	200
NI 14GR	15 x 10 - grey	10	200
NI 14R	15 x 10 - red	10	200
NI 14T	15 x 10 - yellow/green	10	200
NI 14M	15 x 10 - brown	10	200
NI 16N	19 x 25 - black	10	120
NI 16BI	19 x 25 - white	10	120
NI 16BL	19 x 25 - blue	10	120
NI 16GR	19 x 25 - grey	10	120
NI 16R	19 x 25 - red	10	120
NI 16T	19 x 25 - yellow/green	10	120
NI 16M	19 x 25 - brown	10	120
NI 18N	25 x 25 - black	8	96
NI 18BI	25 x 25 - white	8	96

PVC INSULATION TAPE

thickness 0,18 mm

page 87

Code	WidthxLength - colour	Pack	Outer carton
	[mm x m]	[pcs.]	[pcs.]
NI 06N	19 x 20 - black	10	120

SELF-AMALGAMATING TAPE

thickness 0,75 mm

page 88

Code	WidthxLength - colour	Pack	Outer carton
	[mm x m]	[pcs.]	[pcs.]
NI 69A	19 x 10 - black	1	48

HEAVY-DUTY ANCHORS FOR CONCRETE

ETD III

page 95

Code	Description	Pack	Outer carton
		[pcs.]	[pcs.]
060010	8x55/5	100	400
060011	8x70/20-10	100	400
060012	8x90/40-30	50	200
060013	8x130/80-70	50	200
060014	8x160/110-100	50	200
060015	10x65/5	50	200
060016	10x75/15-5	50	200
060017	10x95/36-26	50	200
060018	10x125/65-55	25	100
060019	10x140/80-70	25	100

Code	Description	Pack	Outer carton
		[pcs.]	[pcs.]
060020	12x80/5	25	100
060021	12x100/25-10	25	100
060022	12x115/40-25	25	100
060023	12x140/65-50	25	100
060161	12x160/85-70	20	80
060162	12x180/105-90	20	80
060026	12x220/145-130	20	80
060027	16x100/5	20	80
060028	16x125/30-15	20	80
060029	16x150/55-40	10	40
060030	16x170/75-60	10	40
060031	20x165/50-25	10	40
060032	20x220/105-80	10	40

T11

page 97

Code	Description	Pack	Outer carton
		[pcs.]	[pcs.]
8716301	6x55	100	800
8716325	6x65	100	800
8716303	6x85	100	800
8716326	6x100	100	800
8716304	8x53	100	800
8716305	8x65	100	800
8716328	8x75	100	800
8716306	8x90	100	800
8716329	8x120	50	400
8716330	10x65	50	400
8716308	10x75	50	400
8716309	10x95	50	400
8716310	10x120	25	200
8716311	10x140	25	200
8716331	10x160	25	200
8716314	12x75	25	200
8716315	12x110	25	200
8716316	12x140	25	200
8716333	12x160	20	120
8716334	12x180	20	120
8716318	14x100	20	120
8716319	14x120	20	120
8716320	14x160	20	120
8716336	16x110	20	120
8716322	16x125	20	120
8716323	16x145	20	120
8716324	16x175	20	120
8716337	16x220	15	90

TRIDER

sleeve

page 101

Code	Description	Pack	Outer carton
		[pcs.]	[pcs.]
569550	M5	100	800
569551	M6	100	800
569552	M8	100	800

Code	Description	Pack	Outer carton
		[pcs.]	[pcs.]
569553	M10	50	400

TRIDER/B

zinc hex head screw

page 101

Code	Description	Pack	Outer carton
		[pcs.]	[pcs.]
569555	M5	50	400
569556	M6	50	400
569557	M8	50	400
569558	M10	25	200
PRO-PACK			
569571	M6	16	128
569572	M8	16	128

T101 PIOVRA

sleeve

page 103

Code	Description	Pack	Outer carton
		[pcs.]	[pcs.]
8716000	M6	50	400
8716001	M8	50	400
8716002	M10	25	200
8716003	M12	25	200

T101 PIOVRA/B

hex head screw

page 103

Code	Description	Pack	Outer carton
		[pcs.]	[pcs.]
8716010	M6	50	400
8716011	M8	50	300
8716012	M10	25	150
8716013	M12	20	120

T101 PIOVRA/OC

closed eye hook

page 103

Code	Description	Pack	Outer carton
		[pcs.]	[pcs.]
8716030	M6	50	400
8716031	M8	25	200
8716032	M10	15	120

LE

sleeve

page 105

Code	Description	Pack	Outer carton
		[pcs.]	[pcs.]
8717001	M6	100	800
8717002	M8	100	800
8717003	M10	50	400
8717004	M12	25	200
LEX AISI 304 - plug			
8717011	M6	100	800
8717012	M8	100	800

Code	Description	Pack	Outer carton
		pcs.	pcs.
8717013	M10	50	400
8717014	M12	25	200

LE/B

hex head screw page 105

Code	Description	Pack	Outer carton
		pcs.	pcs.
8717101	M6	50	400
8717102	M8	50	400
8717103	M10	25	200
8717104	M12	20	160
LEX/B AISI 304 - hex head screw			
8717021	M6	50	400
8717022	M8	50	400
8717023	M10	25	200
8717024	M12	20	160

LE/BP

hex head screw and spacer page 105

Code	Description	Pack	Outer carton
		pcs.	pcs.
8717106	M6	50	400
8717107	M8	25	200
8717108	M10	25	150
8717109	M12	20	80

LE/G

zinc plated hook page 105

Code	Description	Pack	Outer carton
		pcs.	pcs.
8717301	M6	50	400
8717302	M8	25	200
8717303	M10	15	120
8717304	M12	10	60

LE/OC

zinc plated eye hook page 105

Code	Description	Pack	Outer carton
		pcs.	pcs.
8717401	M6	50	400
8717402	M8	25	200
8717403	M10	20	120
8717404	M12	10	80

LE/R

anti-tampering hex head screw page 105

Code	Description	Pack	Outer carton
		pcs.	pcs.
8717507	M8x75	25	200

EFPM

sleeve page 107

Code	Description	Pack	Outer carton
		pcs.	pcs.
8715000	M6	50	400
8715001	M8	50	400
8715002	M10	25	200
8715003	M12	25	200

EFPM/B

hex head screw page 107

Code	Description	Pack	Outer carton
		pcs.	pcs.
8715100	M6	50	400
8715101	M8	50	300
8715102	M10	25	150
8715103	M12	20	120
8715104	M 16	10	-

EFPM/G

zinc plated hook page 107

Code	Description	Pack	Outer carton
		pcs.	pcs.
8715300	M6	50	300
8715301	M8	25	200
8715302	M10	15	120

EFPM/OC

closed eye hook page 107

Code	Description	Pack	Outer carton
		pcs.	pcs.
8715200	M6	50	400
8715201	M8	25	200
8715202	M10	20	120
8715203	M12	10	80

HPM

sleeve page 109

Code	Description	Pack	Outer carton
		pcs.	pcs.
8713000	M6	50	400
8713001	M8	50	400
8713002	M10	25	200

HPM/B

zinc head screw page 109

Code	Description	Pack	Outer carton
		pcs.	pcs.
8713010	M6	50	400
8713011	M8	50	300
8713012	M10	25	200

DYNABOLT PLUS/B

hex head screw page 111

Code	Description	Pack	Outer carton
		pcs.	pcs.
050489	M6 - Ø8	100	800
050491	M6 - Ø8	50	400
050492	M6 - Ø8	50	400
050493	M8 - Ø10	50	400
050494	M8 - Ø10	50	300
050495	M8 - Ø10	25	200
050496	M10 - Ø12	25	200
050497	M10 - Ø12	20	160

DYNABOLT PLUS/E

countersunk flat head screw page 111

Code	Description	Pack	Outer carton
		pcs.	pcs.
8723091	M6 - Ø8	100	-
8723092	M6 - Ø8	100	-
8723093	M8 - Ø10	50	-
8723094	M8 - Ø10	50	-
8723096	M10 - Ø12	50	-

T21

page 112

Code	Description	Pack	Outer carton
		pcs.	pcs.
8723050	M6 - Ø8	100	600
8723051	M6 - Ø8	100	600
8723052	M6 - Ø8	100	600
8723053	M6 - Ø8	100	300
8723063	M6 - Ø8	25	150
8723054	M8 - Ø10	50	300
8723056	M8 - Ø10	50	300
8723057	M8 - Ø10	25	150
8723064	M8 - Ø10	25	150
8723065	M8 - Ø10	25	150
8723058	M10 - Ø12	25	150
8723059	M10 - Ø12	25	150
8723066	M10 - Ø12	25	75
8723067	M10 - Ø12	20	120
8723068	M10 - Ø12	25	150
8723060	M10 - Ø12	25	150
8723069	M10 - Ø12	25	75
8723070	M10 - Ø12	25	75
8723061	M12 - Ø14	25	75
8723062	M12 - Ø14	20	60
8723071	M12 - Ø14	15	45
8723072	M12 - Ø14	15	45

EDC

page 113

Code	Description	Pack	Outer carton
		pcs.	pcs.
8750001	8x70	50	-
8750002	8x85	50	-

Code	Description	Pack	Outer carton
		pcs.	pcs.
8750003	10x85	50	-
8750004	10x120	50	-
8750005	12x100	50	-
8750006	12x135	50	-
8750007	14x115	25	-
8750008	14x145	25	-
8750009	16x130	25	-
8750010	16x150	25	-

ETHD

page 114

Code	Description	Pack	Outer carton
		pcs.	pcs.
8724001	M6	200	1.600
8724002	M8	100	800
8724003	M10	100	800
8724004	M12	50	400

T51

page 115

Code	Description	Pack	Outer carton
		pcs.	pcs.
8727002	M5	200	3.200
8727003	M6	300	2.400
8727004	M8	200	1.600
8727005	M10	100	800
8727006	M12	50	400
Industrial version			
8727104	M8	-	2.500
8727105	M10	-	2.000

FRAME ANCHORS

T66/V TORX

countersunk flat head screw page 121

Code	Description	Pack	Outer carton
		pcs.	pcs.
567850	8x60/10	50	400
567851	8x80/30	50	300
567852	8x100/50	50	300
567853	8x120/70	50	300
567854	8x150/100	50	300
567857	10x80/30	50	300
567858	10x100/50	50	200
567859	10x120/70	50	200
567860	10x140/90	50	250
567861	10x160/110	50	250
567862	10x180/130	50	250
567863	10x200/150	50	250
567864	10x230/180	50	200
567865	10x260/210	50	200
567866	10x280/230	50	200
567867	10x300/250	50	150

T66/V TER W

hex head flanged screw page 121

Code	Description	Pack	Outer carton
		pcs.	pcs.
567868	10x60/10	50	300
567869	10x80/30	50	200
567870	10x100/50	50	200
567871	10x120/70	50	250
567872	10x140/90	50	250
567873	10x160/110	50	250
567874	10x180/130	50	250
567875	10x200/150	50	200

T66/V AM

stud head screw and anti-tampering insert

page 121

Code	Description	Pack	Outer carton
		pcs.	pcs.
569465	10x100/50	25	300
569466	10x120/70	25	300
569467	10x140/90	25	150
569468	10x160/110	25	150
569469	10x180/130	25	150

T88/V TORX

countersunk flat head screw page 123

Code	Description	Pack	Outer carton
		pcs.	pcs.
567001	8x80*	50	400
567002	8x100*	50	400
567003	8x120*	50	300
567004	10x80	50	300
567005	10x100	50	200
567006	10x115	50	200
567007	10x145	50	250
567008	10x160	50	250
567009	10x185	50	250
567010	10x210	50	250

* not approved

T88/V POZIDRIV

countersunk flat head screw page 123

Code	Description	Pack	Outer carton
		pcs.	pcs.
566736	8x80*	50	400
566737	8x100*	50	400
566738	8x120*	50	300
566753	10x80	50	300
566754	10x100	50	200
566755	10x115	50	200
566756	10x145	50	250
566757	10x160	50	250
566758	10x185	50	250
566759	10x210	50	250

* not approved

T88/V TE

hex head screw page 123

Code	Description	Pack	Outer carton
		pcs.	pcs.
566733	8x80*	50	400
566734	8x100*	50	400
566735	8x120*	50	300
566746	10x80	50	300
566747	10x100	50	200
566748	10x115	50	200
566749	10x145	50	250
566750	10x160	50	250
566751	10x185	50	250
566752	10x210	50	250

* not approved

T88/V TER *

hex head screw and washer page 123

Code	Description	Pack	Outer carton
		pcs.	pcs.
566765	12x120	25	100
566766	12x145	25	100
566767	12x165	25	100
566768	12x185	25	125
566769	12x210	25	100
566785	16x145	25	125
566786	16x165	25	125
566787	16x185	25	100
566788	16x200	25	100
566789	16x270	15	60

* not approved

APS - PLUG

sleeve page 125

Code	Description	Pack	Outer carton
		pcs.	pcs.
8722505	8x80	100	2.400
8722506	8x100	50	1.200
8722512	8x120	50	1.200
8722507	10x80	50	1.200
8722508	10x100	50	1.200
8722509	10x115	50	1.200
8722510	10x135	50	900
8722511	10x160	50	900

Industrial version

8722605	8x80	-	6.000
8722606	8x100	-	4.000
8722612	8x120	-	3.000
8722607	10x80	-	4.000
8722608	10x100	-	3.000
8722609	10x115	-	2.500
8722610	10x135	-	2.000
8722611	10x160	-	1.500

APS/V POZIDRIV

countersunk flat head screw page 125

Code	Description	Pack	Outer carton
		pcs.	pcs.
8722555	8x80	50	1.200
8722556	8x100	25	600
8722562	8x120	25	600
8722557	10x80	25	600
8722558	10x100	25	600
8722559	10x115	25	400
8722560	10x135	25	300
8722561	10x160	25	300

APS/V TORX

countersunk flat head screw page 125

Code	Description	Pack	Outer carton
		pcs.	pcs.
8722545	8x80	50	1.200
8722546	8x100	25	600
8722552	8x120	25	600
8722547	10x80	25	600
8722548	10x100	25	600
8722549	10x115	25	300
8722550	10x135	25	300
8722551	10x160	25	300
8722553	10x200	25	200

APS/V TE

hex head screw page 126

Code	Description	Pack	Outer carton
		pcs.	pcs.
8722575	8x80	50	800
8722576	8x100	25	600
8722582	8x120	25	600
8722577	10x80	25	600
8722578	10x100	25	400
8722579	10x115	25	400
8722580	10x135	25	300
8722581	10x160	25	300

APS/V TER

hex head screw and washer page 126

Code	Description	Pack	Outer carton
		pcs.	pcs.
8722584	12x130	25	-
8722585	12x200	20	-
8722586	12x240	20	-
8722587	16x140	20	-
8722588	16x160	20	-
8722589	16x200	20	-
8722590	16x240	20	-

APR/V POZIDRIV

countersunk flat head screw page 127

Code	Description	Pack	Outer carton
		pcs.	pcs.
8722001	6x35	100	4.800
8722002	6x50	100	2.400
8722003	6x60	100	2.400
8722004	8x60	50	1.200
8722005	8x80	50	1.200
8722006	8x100	50	800
8722012	8x120	25	800
8722013	8x135	25	600
8722014	8x160	25	450
8722007	10x80	25	600
8722008	10x100	25	600
8722009	10x115	20	480
8722010	10x135	20	360
8722011	10x160	20	360

ETFP

page 128

Code	Description	Pack	Outer carton
		pcs.	pcs.
8707001	8x75	50	800
8707002	8x100	50	800
8707003	8x120	50	800
8707004	8x140	50	600
8707006	10x75	50	800
8707007	10x100	50	400
8707008	10x120	50	400
8707009	10x140	50	300
8707010	10x160	50	300

HAMMER-IN MECHANICAL ANCHORS

JTX

page 129

Code	Description	Pack	Outer carton
		pcs.	pcs.
568666	6x30	200	3.200
568667	6x35	200	3.200
568669	6x40	100	1.600

UCX/VM

pre-mounted iso metric screw with flat lip page 131

Code	Description	Pack	Outer carton
		pcs.	pcs.
8710014	M6/6x35	100	2.400

Industrial version

8710114	M6/6x35	-	4.000
---------	---------	---	-------

UCX/V

pre-mounted countersunk flat head screw with flat lip page 131

Code	Description	Pack	Outer carton
		pcs.	pcs.
8710001	5x25	100	4.800
8710002	5x36	100	4.800
8710003	5x45	100	2.400
8710004	6x35	100	2.400
8710005	6x45	100	2.400
8710006	6x55	100	2.400
8710007	6x70	100	1.800
8710008	8x45	100	1.800
8710009	8x60	50	1.200
8710010	8x75	50	1.200
8710011	8x100	50	1.200
8710012	8x120	50	900
8710013	8x135	50	900

Industrial version

8710101	5x25	-	6.000
8710102	5x35	-	5.000
8710103	5x45	-	4.000
8710104	6x35	-	4.000
8710105	6x45	-	3.000
8710106	6x55	-	2.500
8710107	6x70	-	2.000
8710108	8x45	-	2.000
8710109	8x60	-	1.700
8710110	8x75	-	1.200
8710111	8x100	-	800
8710112	8x120	-	700
8710113	8x135	-	500

UCX TS/V

pre-mounted countersunk flat head screw with countersunk lip

page 131

Code	Description	Pack	Outer carton
		pcs.	pcs.
8710500	4x35*	100	9.600
8710501	5x25	100	4.800
8710502	5x30	100	4.800
8710503	5x45	100	2.400
8710504	6x35	100	2.400
8710505	6x40	100	2.400
8710506	6x55	100	2.400
8710507	6x70	100	1.800
8710508	8x45	100	1.800
8710509	8x60	50	1.200
8710510	8x75	50	1.200
8710511	8x100	50	1.200
8710512	8x120	50	900
8710513	8x135	50	900

Industrial version

8710401	5x25	-	6.000
8710402	5x30	-	5.000
8710403	5x45	-	4.000

Code	Description	Pack	Outer carton
		pcs.	pcs.
8710404	6x35	-	4.000
8710405	6x45	-	3.000
8710406	6x55	-	2.500
8710407	6x70	-	2.000
8710408	8x45	-	2.000
8710409	8x60	-	1.700
8710410	8x75	-	1.200
8710411	8x100	-	800
8710412	8x120	-	700
8710413	8x135	-	500

*not pre-assembled version. Bronzed screw

HXC TB/V

pre-mounted zinc plated pan head screw with rounded lip page 133

Code	Description	Pack	Outer carton
		pcs.	pcs.
8709001	6x35	100	2.400
8709002	6x45	100	2.400
8709003	6x60	100	1.800
8709004	6x70	50	1.200
Industrial version			
8709031	6x35	-	3.500
8709032	6x45	-	2.500
8709033	6x60	-	2.000
8709034	6x70	-	1.500

HXC TB/VZN

pre-mounted black pan head screw with rounded lip page 133

Code	Description	Pack	Outer carton
		pcs.	pcs.
8709306	6x35	100	2.400
8709307	6x45	100	2.400

HXC TB/VR

pre-mounted copper pan head screw with rounded lip page 133

Code	Description	Pack	Outer carton
		pcs.	pcs.
8709301	6x35	100	2.400
8709302	6x45	100	2.400
Industrial version			
8709331	6x35	-	3.500
8709332	6x45	-	2.500

HXC TPL/V

pre-mounted zinc plated pan head screw with flat lip page 133

Code	Description	Pack	Outer carton
		pcs.	pcs.
8709201	6x35	100	2.400
8709202	6x45	100	2.400
8709203	6x60	100	1.800
8709204	6x70	50	1.200

ETCD

pre-mounted zinc plated nail page 134

Code	Description	Pack	Outer carton
		pcs.	pcs.
704005	6x40	100	1.600
704006	6x50	100	800

UNIVERSAL LIGHT DUTY ANCHORS

BLUEFIX

sleeve page 137

Code	Description	Pack	Outer carton
		pcs.	pcs.
568284	5x30	100	1.600
568286	6x35	100	1.600
568287	8x50	50	800

BLUEFIX/VA

countersunk flat head screw page 137

Code	Description	Pack	Outer carton
		pcs.	pcs.
565539	5x30	100	1.600
565540	6x35	100	1.600
565541	8x50	50	800

BLUEFIX/HS

hex head flanged screw page 137

Code	Description	Pack	Outer carton
		pcs.	pcs.
568172	8x50	50	800

BLUEFIX/KS

hex head flanged screw page 137

Code	Description	Pack	Outer carton
		pcs.	pcs.
568179	6x35	50	800

BLUEFIX IN CAN

countersunk flat head screw page 137

Code	Description	Pack	Outer carton
		pcs.	pcs.
565547	5x30	300	2.700
565542	6x35	250	2.250
565548	8x50	150	1350

T6

sleeve page 139

Code	Description	Pack	Outer carton
		pcs.	pcs.
565385	5x25	100	3.200
565386	6x30	100	3.200
565757	6x45	100	1.600
565387	8x40	100	1.600
565758	8x50	50	800
565388	10x50	50	800
565759	10x60	25	400
565281	12x60	25	400
565282	14x70	20	320

Bag

565936	T6/E 5x25	1.000	60.000
565937	T6/E 6x30	1.000	34.000
565938	T6/E 8x40	1.000	16.000
565939	T6/E 10x50	500	8.000

T6/VA

countersunk flat head screw page 139

Code	Description	Pack	Outer carton
		pcs.	pcs.
565389	5x25	100	3.200
565390	6x30	100	1.600
565882	6x45	50	800
565391	8x40	50	800
565883	8x50	50	800
565392	10x50	25	400
565884	10x60	25	400

T6/V TER

hex head screw and washer page 139

Code	Description	Pack	Outer carton
		pcs.	pcs.
565760	8x40	50	800
565761	10x50	50	400
565762	12x60	50	300
565763	14x70	25	200

T6/VN

countersunk pan head screw page 139

Code	Description	Pack	Outer carton
		pcs.	pcs.
565393	6x30	100	1.600
565394	8x40	50	800

T6/VX

pan head flanged screw page 139

Code	Description	Pack	Outer carton
		pcs.	pcs.
565395	6x30	100	1.600

T6/VKC

pan head flanged screw; long pitch thread page 139

Code	Description	Pack	Outer carton
		pcs.	pcs.
568686	6x30	200	2.400

E

sleeve page 141

Code	Description	Pack	Outer carton
		pcs.	pcs.
8701001	4x20	200	19.200
8701002	5x25	200	19.200
8701003	6x30	100	9.600
8701004	8x40	100	4.800
8701005	10x50	50	2.400
8701006	12x60	25	1.200
8701007	14x75	20	960
8701037	14x100	25	600
8701009	16x80	10	480

Bag

8701101	4x20	1.000	100.000
8701102	5x25	1.000	70.000
8701103	6x30	1.000	38.000
8701104	8x40	1.000	18.000
8701105	10x50	500	9.000
8701106	12x60	250	5.500
8701107	14x75	200	3.200

Industrial

8701011	4x20	-	100.000
8701012	5x25	-	45.000
8701013	6x30	-	30.000
8701014	8x40	-	12.000
8701015	10x50	-	6.000
8701018	10x60	-	5.500
8701016	12x60	-	3.500
8701017	14x75	-	2.000
8701035	14x100	-	1.000
8701019	16x80	-	1.800
8701034	16x110	-	1.300

E/VA

countersunk flat head screw no lip page 141

Code	Description	Pack	Outer carton
		pcs.	pcs.
8702052	5x25	100	6.400
8702053	6x30	100	3.200
8702054	8x40	50	1.600
8702055	10x50	50	800

EB

lipped anchor page 142

Code	Description	Pack	Outer carton
		pcs.	pcs.
8701052	5x25	200	19.200
8701053	6x30	100	9.600
8701054	8x40	100	4.800
8701055	10x50	50	2.400
8701058	10x60	50	2.400
8701056	12x60	25	1.200
Bag			
8701152	5x25	1.000	60.000
8701153	6x30	1.000	34.000
8701154	8x40	1.000	16.000
8701155	10x50	500	8.000
Industrial			
8701062	5x25	-	45.000
8701063	6x30	-	25.000
8701064	8x40	-	11.000
8701065	10x50	-	6.000

EB/VA

lipped with countersunk flat head screw page 142

Code	Description	Pack	Outer carton
		pcs.	pcs.
8702262	5x25	100	6.400
8702263	6x30	100	3.200
569543	6x30 - Screw 5,0x40	200	4.800
8702264	8x40	50	1.600
8702265	10x50	50	800

EB/P

lipped with accessories page 142

Code	Description	Pack	Outer carton
		pcs.	pcs.
8702423	QA 6x30	100	2.400
8702413	GM 6x30	100	2.400
8702433	OC 6x30	100	2.400
8702403	GC 6x30	100	2.400
8702443	GO 4x20	10	600

T4/VA

page 143

Code	Description	Pack	Outer carton
		pcs.	pcs.
566135	6x35	100	4.800
566136	6x45	50	2.400
566137	8x50	50	2.400
566138	10x60	25	1.200

TPFC

lipped anchor page 145

Code	Description	Pack	Outer carton
		pcs.	pcs.
8705111	6x38	100	9.600
8705112	8x51	50	2.400
8705113	10x61	25	1.200
Bag			
8705131	6x38	1.000	25.000
8705135	6x51	1.000	14.000
8705132	8x51	1.000	12.000
8705133	10x61	500	6.000
Industrial version			
8705184	5x31	-	25.000
8705181	6x38	-	20.000
8705185	6x51	-	14.000
8705182	8x51	-	9.000
8705183	10x61	-	5.000

TPF

non-lipped anchor page 145

Code	Description	Pack	Outer carton
		pcs.	pcs.
8705194	5x30	-	30.000
8705191	6x37	-	25.000
8705192	8x50	-	10.000
8705193	10x60	-	5.000

ENP/V

countersunk pan head screw - washer head page 147

Code	Description	Pack	Outer carton
		pcs.	pcs.
8700001	9x40	200	1.600
8700016	9x50	100	1.200
8700020	12x45	100	800
8700035	12x55	50	600

ENP/GC

short hook page 147

Code	Description	Pack	Outer carton
		pcs.	pcs.
8700003	9x40	200	1.600
8700017	9x50	100	1.200
8700022	12x45	100	800
8700036	12x55	50	600

ENP/GM

medium hook page 147

Code	Description	Pack	Outer carton
		pcs.	pcs.
8700005	9x40	200	1.600
8700024	12x45	100	800
8700037	12x55	50	600

ENP/GL

long hook page 147

Code	Description	Pack	Outer carton
		pcs.	pcs.
8700007	9x40	100	1.200
8700026	12x45	50	600

ENP/OA

eye hook page 148

Code	Description	Pack	Outer carton
		pcs.	pcs.
8700009	9x40	100	1.200
8700028	12x45	50	600

ENP/OC

closed eye hook page 148

Code	Description	Pack	Outer carton
		pcs.	pcs.
8700011	9x40	100	1.200
8700041	9x50	100	800
8700030	12x45	50	600
8700045	12x55	50	400

ENP/DD

rod and double nut page 148

Code	Description	Pack	Outer carton
		pcs.	pcs.
8700013	9x40	100	1.200
8700032	12x45	50	600

ENP/FP

doorstop page 148

Code	Description	Pack	Outer carton
		pcs.	pcs.
8700039	9x40 White	50	400
8700040	9x40 Black	50	400

T61/DB

frame anchor with countersunk pan head screw page 151

Code	Description	Pack	Outer carton
		pcs.	pcs.
569544	9x80 M5	100	600
569545	9x80 M6	100	600

T61/V

countersunk pan head screw page 151

Code	Description	Pack	Outer carton
		pcs.	pcs.
8712047	6x25	100	3.200
8712050	8x35	100	800

Code	Description	Pack	Outer carton
		pcs.	pcs.
8712051	8x35	100	800
8712052	9x40	100	600
8712053	9x40	100	600

T61/GC

short hook page 151

Code	Description	Pack	Outer carton
		pcs.	pcs.
8712048	6x25	100	1.600
8712054	8x35	100	800
8712055	9x40	100	600

T61/GM

medium hook page 151

Code	Description	Pack	Outer carton
		pcs.	pcs.
8712056	8x35	100	800
8712057	9x40	100	600

T61/OA

eye hook page 151

Code	Description	Pack	Outer carton
		pcs.	pcs.
8712060	8x35	100	600
8712061	9x40	100	400

T61/OC

closed eye hook page 151

Code	Description	Pack	Outer carton
		pcs.	pcs.
8712049	6x25	100	1.600
8712062	8x35	100	600
8712063	9x40	100	400

T61/DD

rod and double nut page 151

Code	Description	Pack	Outer carton
		pcs.	pcs.
8712064	8x35	100	600
8712065	9x40	50	300
8712066	9x40	50	300

XTECH/VCB

pan head screw page 152

Code	Description	Pack	Outer carton
		pcs.	pcs.
565892	10x50-M5	100	600
565898	10x60-M5	100	600

XTECH/P

with accessories page 152

Code	Description	Pack	Outer carton
		pcs.	pcs.
565894	GM10x50-M5	100	600
565895	OA 10x50-M5	100	600
565896	OC 10x50-M5	100	600

EMS

page 153

Code	Description	Pack	Outer carton
		pcs.	pcs.
8719101	12.9.70	50	200
8719102	12.9.100	50	200
8719103	12.9.120	50	200
8719104	12.9.140	50	200
8719105	12.12.100	20	80
8719106	12.12.120	20	80
8719107	12.12.140	20	80
8719108	14.14.120	20	80
8719109	14.14.145	20	80
8719110	14.14.170	20	80

PLASTERBOARD MECHANICAL ANCHORS

T-CLICK

page 154

Code	Description	Pack	Outer carton
		pcs.	pcs.
566261	TP 10	25	2.400
566301	TP 10	100	2.400

DRIVA

page 155

Code	Description	Pack	Outer carton
		pcs.	pcs.
569443	TP 12	100	400
569444	TF 5	100	400
569445	TF 27	100	400

DRIVA IN CAN

page 155

Code	Description	Pack	Outer carton
		pcs.	pcs.
568144	TP 12	150	1.800

DRIVA NYLON

page 156

Code	Description	Pack	Outer carton
		pcs.	pcs.
569442	NYLON TP 12	200	800

MINI DRIVA

page 157

Code	Description	Pack	Outer carton
		pcs.	pcs.
565398	MINI DRIVA	200	6.400

ETPV- ZENTECH

page 158

Code	Description	Pack	Outer carton
		pcs.	pcs.
569546	ZENTECH M4/8x34-40	100	1.600
568617	M4/8x35-41	100	1.600
568618	M4/8x40-47	100	1.600
569547	ZENTECH M5/10x34-40	50	800
568621	M5/10x50-59	50	800
568622	M5/10x63-72	50	800
569548	ZENTECH M6/12x35-40	50	800

INSTALLATION TOOL ETPV

page 160

Code	Description	Pack	Outer carton
		pcs.	pcs.
707070	TOOL	1	-

ETAF/V

countersunk pan head screw page 160

Code	Description	Pack	Outer carton
		pcs.	pcs.
8706001	4/12	50	600
8706002	4/14	50	600
569540	5/14	50	600

ETAF/DC

rod and cup nut page 160

Code	Description	Pack	Outer carton
		pcs.	pcs.
8706351	4/12	50	600
8706352	4/14	50	600

ETAF/OA

eye hook page 162

Code	Description	Pack	Outer carton
		pcs.	pcs.
8706201	4/12	50	600

Code	Description	Pack	Outer carton
		pcs.	pcs.
8706202	4/14	50	600
569541	5/14	50	600

ETAF/OC

closed eye hook page 160

Code	Description	Pack	Outer carton
		pcs.	pcs.
8706101	4/12	50	600
8706102	4/14	50	600
569542	5/14	50	600

ETAF/DD

rod and double nut page 160

Code	Description	Pack	Outer carton
		pcs.	pcs.
8706301	4/12	50	600
8706302	4/14	50	600

ETR/DD

rod and double nut page 161

Code	Description	Pack	Outer carton
		pcs.	pcs.
8706303	M6	25	300
8706304	M8	25	200

ETR/OA

eye hook page 161

Code	Description	Pack	Outer carton
		pcs.	pcs.
8706203	M6	25	300
8706204	M8	25	200

ETNF

page 162

Code	Description	Pack	Outer carton
		pcs.	pcs.
8711000	10x38	100	5.000
8711001	10x47	100	5.000

LIGHT-DUTY ANCHORS FOR INSULATION PANELS

EIS-D

sleeve page 164

Code	Description	Pack	Outer carton
		pcs.	pcs.
568176	EIS-D	50	400

EIS-D/V

pan head screw page 164

Code	Description	Pack	Outer carton
		pcs.	pcs.
568177	EIS-D/V	50	300

EIS-D LT - PLUG

page 166

Code	Description	Pack	Outer carton
		pcs.	pcs.
568174	EIS-D LT	50	400

EIS-D LT/V

pan head screw page 164

Code	Description	Pack	Outer carton
		pcs.	pcs.
568175	EIS-D LT/V	50	300

EIS-D 95

sleeve page 164

Code	Description	Pack	Outer carton
		pcs.	pcs.
568178	EIS-D 95/8	50	200

SPECIAL FIXING FOR ELECTRICAL INSTALLATIONS

ECLIP

page 165

Code	Description	Pack	Pallet
		pcs.	pcs.
13502116	16	100	1.200
13502120	20	100	1.200
13502125	25	100	1.200
13502132	32	50	600
13502140	40	50	600
13502150	50	20	240
Industrial version			
13502016	16	-	4.000
13502020	20	-	3.000
13502025	25	-	2.200
13502032	32	-	1.700
13502040	40	-	1.200
13502050	50	-	900

CT-CLIP

page 166

Code	Description	Pack	Pallet
		pcs.	pcs.
565510	16-32 mm	100	1.000
565511	40-63 mm	100	1.000

ELEFIX

page 167

Code	Description	Pack	Outer carton
		pcs.	pcs.
565958	16-32 mm	100	1.200
565961	40-63 mm	100	600

ELEFIX M7 ANCHOR

page 167

Code	Description	Pack	Outer carton
		pcs.	pcs.
565940	D8 37x8	100	1.600

Installation tool included in the pack

ECAV

page 168

Code	Description	Pack	Outer carton
		pcs.	pcs.
13501008	8	200	2.400
13501012	12	100	1.200
13501016	16	75	900
13501020	20	50	600
13501025	25	50	600
13501032	32	25	300
13501040	40	20	240
13501050	50	15	180

S-CLIP

page 169

Code	Description	Pack	Outer carton
		pcs.	pcs.

Single version

569485	S-CLIP S can	100	
569486	S-CLIP S can	100	
569487	S-CLIP S can	100	

Double version

569488	S-CLIP D can	100	
569489	S-CLIP D can	100	
569490	S-CLIP D can	100	

CLAMPS M6

page 170

Code	Description	Pack	Outer carton
		pcs.	pcs.
8730223	M6 16 ZG	100	800
8730224	M6 18 ZG	100	800
8730225	M6 20 ZG	100	1.200
8730226	M6 22 ZG	100	1.200
8730227	M6 24 ZG	100	1.200
8730228	M6 26 ZG	100	1.200
8730229	M6 32 ZG	100	600

SPECIAL FIXING FOR HVAC INSTALLATIONS

E/GL

page 171

Code	Description	Pack	Outer carton
		pcs.	pcs.
8411001	3/8"	2	100
8411002	1/2"	2	100
8411003	3/4"	2	100
8411004	1"	2	100
8411005	1 1/4"	2	100
8411006	1 1/2"	2	100
8411007	2"	2	50
8411008	2 1/2"	2	50
8411009	3"	2	30
8411010	4"	2	30

EMB

page 172

Code	Description	Pack	Outer carton
		pcs.	pcs.
8719812	12x70	2	200
8719814	14x75	2	200
8719922	12x70*	2	200
8719924	14x75*	2	200

*Replacement

EMC

page 172

Code	Description	Pack	Outer carton
		pcs.	pcs.
8719714	14x75	2	100
8719924	14x75*	2	200

*Replacement

EB/SB

page 172

Code	Description	Pack	Outer carton
		pcs.	pcs.
8714102	10X75	2	100
8714103	10X95	2	100
8714104	10X120	2	100

ETS/V

page 172

Code	Description	Pack	Outer carton
		pcs.	pcs.
8714203	Inox	4	200

ETS/L

page 173

Code	Description	Pack	Outer carton
		pcs.	pcs.
8714303	10x100	2	100
8714304	10x120	2	100
8714305	10x140	2	100

MANUAL NAILING AND ACCESSORIES

STEEL NAIL

page 174

Code	Description	Pack	Outer carton
		pcs.	pcs.
8412122	18 mm	200	4.000

NAILS HAMMER WITH ERGONOMIC GRIP

page 174

Code	Description	Pack	Outer carton
		pcs.	pcs.
8412123	nails hammer	1	-

POLYPROPYLENE STRAP

page 174

Code	Description	Pack	Outer carton
		pcs.	pcs.
8412120	10 m	1	10

STRAP KIT

page 174

Code	Description	Pack	Outer carton
		pcs.	pcs.
KIT MANUALE		1	-

EBAN

page 174

Code	Description	Pack	Outer carton
		pcs.	pcs.
8412001	12x0,8	1	10
8412002	17x0,8	1	10
8412003	26x1,0	1	10

EDS

page 175

Code	Description	Pack	Outer carton
		pcs.	pcs.
8720001	6x20 - FF	100	1.200
8720002	6x30 - FF	100	1.200
8720003	6x40 - FF	50	600

Code	Description	Pack	Outer carton
		pcs.	pcs.
8720004	8x20 - FF	100	800
8720005	8x30 - FF	100	800
8720006	8x40 - FF	50	400
8720007	10x20 - FF	100	800
8720008	10x30 - FF	50	400
8720009	12x30 - FF	50	400
8720011	6x20 - MF	100	1.200
8720012	6x30 - MF	100	1.200
8720013	6x40 - MF	50	600
8720014	6x50 - MF	50	600
8720015	8x20 - MF	100	800
8720016	8x30 - MF	100	800
8720017	8x40 - MF	50	400
8720018	8x50 - MF	50	400

CHEMICAL ANCHORS

PRIMEBLOK

page 181

Code	Description	Pack	Outer Carton
		pcs.	pcs.
059511	280cc	1	12
059510	410 cc	1	12

KIT STARBLOK WITH PRIMEBLOK

page 183

Code	Description	Pack	Outer Carton
		pcs.	pcs.
568705		1	6
568706		1	6

Mixer included

STARBLOK

page 183

Code	Description	Pack	Outer Carton
		pcs.	pcs.
569481	STARBLOK 16/ M6-M10	50	250

Mixer included

MULTIBLOK

page 185

Code	Description	Pack	Outer Carton
		pcs.	pcs.
059513	300 cc	1	12
059512	410 cc	1	12

EHD

page 185

Code	Description	Pack	Outer Carton
		pcs.	pcs.
8730101	M8x110	10	-
8730102	M10x110	10	-
8730104	M10x160	10	-
8730105	M12x115	10	-
8730107	M16x190	5	-

BT

injection anchor sleeve page 185

Code	Description	Pack	Outer Carton
		pcs.	pcs.
8708981	BT M8	10	200
8708982	BT M10	10	200
8708983	BT M12	10	200

BE

Polyethylene injection anchor sleeve

page 185

Code	Description	Pack	Outer Carton
		pcs.	pcs.
8708955	BE 12x45	10	200
8708956	BE 12x60	10	200
8708957	BE 12x80	10	200
8708952	BE 15x85	10	200
8708953	BE 15x130	10	200
8708954	BE 20x85	10	200
Industrial version			
8708935	BE/ 12x45	-	6.500
8708936	BE/ 12x60	-	4.500
8708937	BE/ 12x80	-	3.000
8708932	BE/ 15x85	-	2.000
8708933	BE/ 15x130	-	1.200
8708934	BE/ 20x85	-	1.200

BM

metallic injection anchor sleeve

page 185

Code	Description	Pack	Outer Carton
		pcs.	pcs.
8708961	BM 12x1000	1	10
8708962	BM 16x1000	1	10
8708963	BM 22x1000	1	6

BLISTER

BLUEFIX

page 137

Code	Description	Blister	Outer carton
		pcs.	blister
565537	BLUEFIX 6x35	20	10
565538	BLUEFIX 8x50	15	10

Code	Description	Blister	Outer carton
		pcs.	blister
565535	BLUEFIX/VA 6x35	15	10

T6

page 139

Code	Description	Blister	Outer carton
		pcs.	blister
565964	T6 5x25	35	15
565965	T6 6x30	30	15
565966	T6 8x40	20	10
565967	T6 10x50	10	10
565968	T6 12x60	5	10
565969	T6/VA 5x25	20	15
565329	T6/VA 6x30	15	10
565401	T6/VA 8x40	10	10
565970	T6/VA 10x50	4	10

E

page 141

Code	Description	Blister	Outer carton
		pcs.	blister
565973	E 4x20	35	15
565402	E 5x25	35	15
565403	E 6x30	30	15
565404	E 8x40	20	10
565405	E 10x50	10	10
565408	E/VA 5x25	20	15
565409	E/VA 6x30	15	10
565410	E/VA 8x40	10	10
565411	E/VA 10x50	4	10
565418	E/GO 4x20	10	15

EB

page 142

Code	Description	Blister	Outer carton
		pcs.	blister
565977	EB/VA 5x25	20	10
565978	EB/VA 6x30	15	10
565979	EB/VA 8x40	10	10
565980	EB/VA 10x50	4	10
565414	EB/GC 6x30	10	15
565415	EB/GM 6x30	10	10
565416	EB/OA 6x30	10	10
565417	EB/OC 6x30	10	10

T4

page 143

Code	Description	Blister	Outer carton
		pcs.	blister
566019	T4/VA 6x35	10	10
566021	T4/VA 8x50	8	10
566022	T4/VA 10x60	4	10

ENP

page 147

Code	Description	Bliester	Outer carton
		pcs.	blister
565426	ENP/V 9x40	6	8
565433	ENP/V 12x45	4	8
565425	ENP/GC 8x40	6	8
565427	ENP/GC 9x40	6	8
565434	ENP/GC 12x45	4	8
565428	ENP/GM 9x40	6	8
565435	ENP/GM 12x45	4	8
565429	ENP/GL 9x40	6	8
565430	ENP/OA 9x40	6	8
565436	ENP/OA 12x45	4	8
565431	ENP/OC 9x40	6	8
565437	ENP/OC 12x45	4	8
565432	ENP/DD 9x40	6	8
565991	ENP/FP bianco 9x40	2	8
565992	ENP/FP nero 9x40	2	8

T61

page 151

Code	Description	Bliester	Outer carton
		pcs.	blister
565438	T61/VP 9x40	4	8
565439	T61/GC 9x40	4	8
565440	T61/GM 9x40	4	8
565441	T61/OA 9x40	4	8
565442	T61/OC 9x40	4	8

T51

page 115

Code	Description	Bliester	Outer carton
		pcs.	blister
565452	T51 M6	8	10
565453	T51 M8	6	10

DRIVA NYLON

page 156

Code	Description	Bliester	Outer carton
		pcs.	blister
565463	DRIVA NYLON	10	15

T-CLICK

page 154

Code	Description	Bliester	Outer carton
		pcs.	blister
566023	T-CLICK TP 10	4	15

DRIVA

page 155

Code	Description	Bliester	Outer carton
		pcs.	blister
565464	DRIVA TP 12	4	15

ETAF

page 162

Code	Description	Bliester	Outer carton
		pcs.	blister
566006	ETAF/V 4/12	2	8
565459	ETAF/V 4/14	2	8
565460	ETAF/DC 4/14	2	8
566004	ETAF/OC 4/12	2	8
566005	ETAF/OA 4/12	2	8
565461	ETAF/OA 4/14	2	8
566003	ETAF/DD 4/12	2	8

APS

page 125

Code	Description	Bliester	Outer carton
		pcs.	blister
565997	APS/V 8x80	10	10
565449	APS/V 8x100	10	10
565998	APS/V 8x120	10	10
565999	APS/V 10x80	6	10
565450	APS/V 10x100	8	10

UCX

page 131

Code	Description	Bliester	Outer carton
		pcs.	blister
565444	UCX 6x35	20	10
565445	UCX 6x55	15	10
565446	UCX 6x70	15	8
565447	UCX 8x75	10	10
565448	UCX 8x100	6	10

UCX TS

page 131

Code	Description	Bliester	Outer carton
		pcs.	blister
565443	UCX TS 4x35	25	10

LE

page 105

Code	Description	Bliester	Outer carton
		pcs.	blister
565469	LE/B M6	4	8
565470	LE/B M8	4	8
566010	LE/B M10	2	8
565471	LE/G M6	2	8
565472	LE/G M8	2	8
565473	LE/OC M6	2	8
565474	LE/OC M8	2	8

EFPM

page 107

Code	Description	Bliester	Outer carton
		pcs.	blister
565466	EFPM/B M6	2	8
565467	EFPM/B M8	2	8
565468	EFPM/B M10	2	8
566012	EFPM/G M8	2	8
566014	EFPM/OC M8	2	8

EMS

page 153

Code	Description	Bliester	Outer carton
		pcs.	blister
566054	EMS 12.9.70	2	10
565475	EMS 12.9.100	2	10
566056	EMS 12.9.120	2	10
566057	EMS 12.9.140	2	10
565477	EMS 12.12.100	2	10
565476	EMS 12.12.140	2	10
565478	EMS 14.14.120	2	10
565479	EMS 14.14.145	2	10
565480	EMS 14.14.170	2	10
565481	EM spare part	4	10
565482	EM spare part	4	10

A series of 30 horizontal dotted lines for writing.

A series of horizontal dotted lines for writing.

A series of horizontal dotted lines for writing.

SALE CONDITIONS

Product features

Product features, illustrations and brands referred in this catalogue are approximate and subject to modification without any obligation of notice from ITW Construction Products Italy S.r.l. to the client. The sale of products is reserved for Dealers and professional users in possession of a VAT number.

Liability

In any case, the responsibility of ITW Construction Products Italy S.r.l. is limited to the amount of the prices displayed on the invoice. In no case our society can be held liable for loss of profits, contracts, turnover, financial losses and/or consequential damages caused by our company to the buyer and/or third parties.

Orders confirmation

Orders are accepted without obligation by ITW Construction Products Italy S.r.l., which is responsible for any fulfilment decision. If any client solvency or commercial correctness loss occur ITW Construction Products Italy S.r.l. will have the faculty to suspend or cancel, at its sole discretion, ongoing orders even if confirmed. The execution of the supply can be suspended following changes to the assets of the client, under art. 1461 C.C. Within 24 hours from ITW order confirmation dispatch, the commercial conditions are considered accepted.

Prices

Prices are for goods ex-works (Incoterms 2000) - packaging, VAT, transport are excluded and not binding. Prices in effect are those applicable on the day the order is received and are considered valid only if confirmed by our society.

Packs

On orders, please follow the quantities or multiples of the packages shown in the catalogue. We do not accept orders smaller than minimum pack quantity.

Delivery

Terms of delivery, even if confirmed, are purely indicative and not binding for our company. Any delay does not affect the validity of the order, nor does it authorize the request for damages and/or penalties for delayed delivery.

Shipments

Unless otherwise expressly agreed in writing with the client, shipment will be arranged by ITW Construction Products Italy S.r.l. in such manner as it considers appropriate and without any responsibility. Goods always travel at the risk and peril of the customer, even if ITW Construction Products Italy S.r.l. will agree to cover the specific transport costs. In case of shortfall, damage, delay during transport, damages must be requested to the carrier, the only responsible subject.

Major force

In case of any "force majeure" event, whether this is of a productive nature or deriving from an accident that directly or indirectly affects the shipment of goods, the company reserves the right to suspend commitments without notice and/or recognition of compensation. The following events are considered "force majeure": natural disaster, strike or delayed deliveries, explosions, fires, acts of war and/or sabotage, embargo, public unrest, interruptions or delays in transport. This list is to be considered indicative, but not exhaustive.

Payments / Retention of ownership

All payments must be made exclusively to ITW Construction Products Italy S.r.l. Complaints of any kind do not suspend the obligation to make payments according to the agreed form. Rounding and arbitrary restraints are not accepted for any reason. Any discounts granted or previously agreed must be calculated on the amount of the goods excluding VAT, packaging and any transport costs. Payments that do not comply with the agreed conditions will be rejected. If the client does not provide timely payment at the due dates and within the agreed terms, ITW Construction Products Italy S.r.l. will

have the right to suspend the execution of the order immediately, without any prejudice or damaging action may be imputed to the company. The customer will also have the obligation to immediately pay all the goods supplied, as well as default interest at the statutory applicable rate.

Insolvency

In the event of protest of routes with discount for ready cash benefit, the aforementioned discount will be recovered, and the invoice must be paid for whole plus protest costs.

Complaints

Goods shipment must be examined upon delivery by the client or by one of its staff responsible to receive it. The client shall promptly notify the company and the carrier where relevant, of any damage, defect or shortage reasonably apparent to the client on reasonable examination of the Goods. After 48 hours from the delivery no complaints are accepted. No compensation for expenses or damages of any kind will be recognized.

Returns and Substitutions

Any return or product replacement will be accepted no later than 15 days from the date of receipt of the goods.

The return must be previously authorized by ITW Construction Products Italy S.r.l., to which a sampling of the disputed material to carry out quality checks. Only if the disputed material proves to be non-compliant with the intended characteristics, ITW Construction Products Italy S.r.l. will authorize the return.

The return must be sent via carriage to the location indicated by the company and accompanied by the transport document, specifying the reason for made and indicating the details of the invoice with which the goods were previously supplied.

If the goods checked will result tradable (unopened packaging), a credit note will follow.

For goods returned due to client's error, the credit will be made only after the goods have been taken over by the company warehouse and subsequently the packaging quality and integrity check. If from the control the goods will comply to the company quality standards, a credit note will follow, the value of which will be agreed beforehand between the parties.

Disputes

For any dispute and/or complaint, the arbitration chamber established at the Chamber of Commerce of Padua is competent.

REGISTERED OFFICE

ITW Construction Products Italy srl
Viale Regione Veneto 5 35127 Padova Z.I. (PD) - Italy

COMMERCIAL OFFICE

Via Lombardia, 10 30030 Cazzago di Pianiga (VE) - Italy

T. (+39) 041 51 35 511

F. (+39) 041 51 35 568

PRODUCTION

Cable ties:

Via Edison, 23 35010 Cadoneghe (PD) Italy

Fixing systems:

Viale Regione Veneto, 5 35127 Padova Z.I. (PD) Italy

info@itw-italy.com

www.itw-italy.com